

USER MANUAL

Poursteady
PS1 and PS1-3c

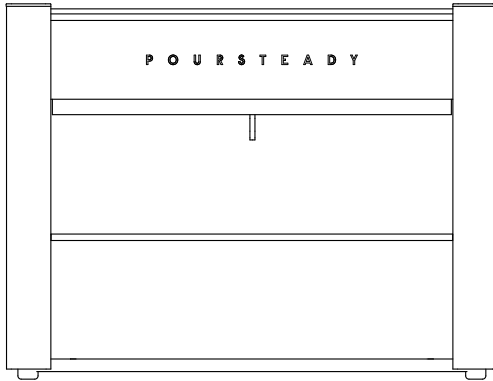

These instructions apply only to the Poursteady PS1 and PS1-3c. Refer to manuals provided with any other equipment, including the Marco UC-4/UC-10 Ecosmart boilers used in conjunction with this appliance, for instructions pertaining to additional appliances.

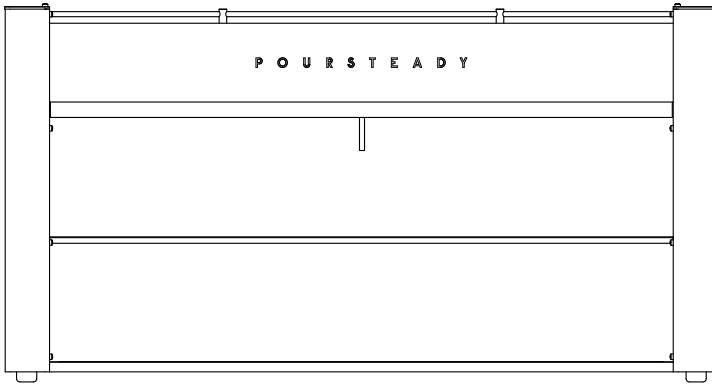

U.S. PAT. 9,808,114.

Requirements

- The maximum and minimum ambient temperatures for correct operation are 45°C/113°F and 1°C/33°F.
- The appliance is not suitable for installation in an area where a water jet could be used.
- The appliance is only to be used with the detachable power supply unit provided.
- The appliance is not to be used by persons (including children) with reduced physical, sensory or mental capabilities, or lack of experience and knowledge, unless they have been given supervision or instruction.
- Children shall not play with the appliance.
- Access to the service area should only be permitted to persons having knowledge and practical experience of the appliance, in particular as far as safety and hygiene are concerned.
(EN 60335275)
- The sound pressure level for this appliance is below 70dBA.
- Each Poursteady machine requires a valid internet connection in order to communicate with the Poursteady database and telemetry services.
(Read more detailed instructions on page 13).

Safety

Please use caution when using, installing, operating, or servicing this appliance!

- Beware of hot water. This machine is designed to dispense extremely hot water. There is a risk of scalding.
- Beware of moving parts. The nozzle of this machine moves very quickly from one location to another.
- Install in a safe location so that customers are not able to touch the hot or moving parts.
- Keep away from children or anyone who has not been properly trained on how to safely touch, use, or operate this appliance.
- All electrical connections must be sized, installed, and maintained in accordance with federal, state, and local codes.
- Water pipe connections and fixtures directly connected to a potable water supply shall be sized, installed, and maintained in accordance with federal, state, and local codes.



Warnings

1. NEVER attach any water source other than the Marco UC boilers.
2. Avoid rapid power cycling of this machine; wait 15 seconds between unplugging and replugging.
3. Avoid spilling liquid into the machine. Do not store pitchers on the machine.
4. Only use mild detergents for cleaning.

Package Contents

The Poursteady PS1/PS1-3c ships with everything necessary to connect to a Marco Ecosmart UC4 or UC10 under-counter water boiler (not included).

In the Box

- Poursteady PS1 / PS1-3c machine
- Length of silicone drain tube
- USB Wi-Fi Adapter with extension cable
- 24V Power Supply
- Length of insulation for the hot-water supply tube
- Pump control wire
- Drain-tube brush
- User Manual

Inside the Machine

Connections

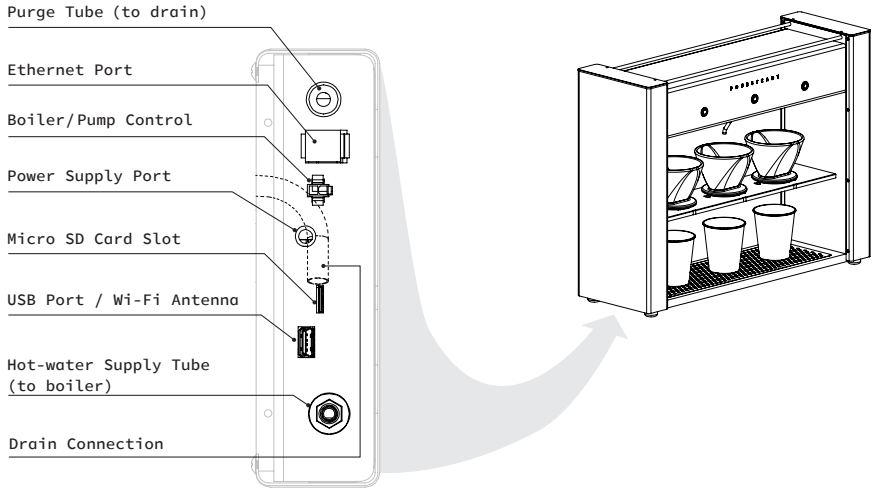

Section View

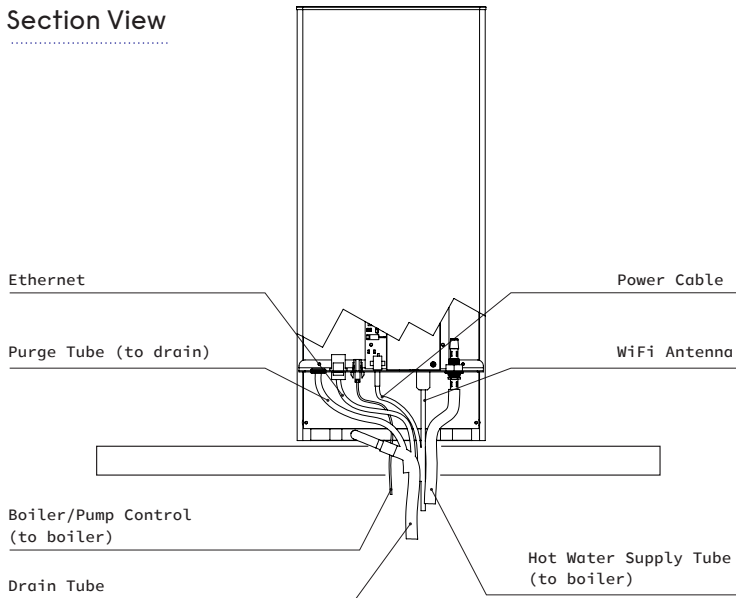

Installation

Before you install, make sure you have the listed requirements below.

- INPUT: 100-240VAC, 50/60Hz, 1.4A. Plug type may vary regionally.
- Available network access via ethernet cable (located near machine installation) and/or Wi-Fi network, using common default ports.
- Adequate counter space with the ability to cut a 1.75in (45mm) diameter hole in the counter to pass through plumbing, data and electrical connections.
- A Marco UC4 or UC10 under-counter boiler installed directly beneath the Poursteady machine
NOTE: Please refer to the Marco installation guide for more information. The Marco UC10 requires 240V power at 30A via a NEMA L6-30 receptacle. The Marco UC4 requires 240V power at 20A via a NEMA L6-20 receptacle.
- Drainage

1 Cut hole in counter-top

- Locate the Poursteady PS1/PS1-3c with the buttons facing the operator in the desired location. Place a temporary mark for reference.
- Cut a 1.75in (45mm) diameter hole in the counter as shown below:



2 Install Marco UC Boiler

- Position the hot-water heater directly below, or as close as possible to the hole in your counter-top.
- Follow all installation instructions provided with the hot-water heater—including water and power requirements.
- Note: Water quality will affect the lifetime performance of both the boiler and the Poursteady brewer.

 **DO NOT TURN ON BOILER**

3 Position Poursteady

- Move the Poursteady so that the left-side of the operator's side of the machine (facing the buttons) is over the hole.
- Remove the left-hand cover by removing the 2 screws on the top of the machine, and then the 8-screws along the sides. Carefully slide the panel up. (Tip: to keep the electronics covered, you can slide the panel up a few inches and secure it in place temporarily with one of the screws.)

4 Connect Poursteady

- Connect all fittings including drain tube, pump control wire, power supply, USB Antenna. Run all connections through the counter, making sure that there are no kinks in the plumbing.

5 Secure 24V power supply

- The 24V power supply should be secured under the counter close to both the Poursteady and the 110V socket.



DO NOT PLUG INTO THE WALL

6 Connect drain tube

- The silicone tube fitted to the outlet coming out of the drip tray on the Poursteady (shown below) should pass through the hole in the counter.
- Cut to length (if desired).
- Insert the loose end into the drain and secure. It is very important that there are no kinks or high spots in the line as it runs from the the machine to the drain. These will result in poor drainage and potential overflow of the drip tray.

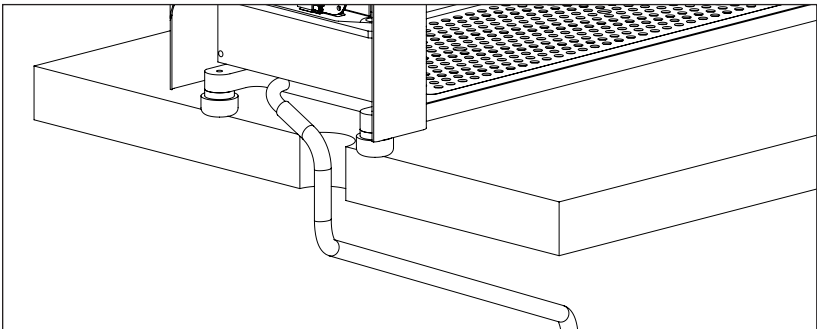

7 Connect hot-water supply tube to Marco boiler

- The hot water supply tube and black insulation connected to the Poursteady (see below) should pass through the slot in the counter.
- Bring the loose end of the tubing and insulation to the barbed OUT fitting on the top of the Marco and cut to length (if desired).
- Carefully work the plastic tube over the barbed-fitting until secure.

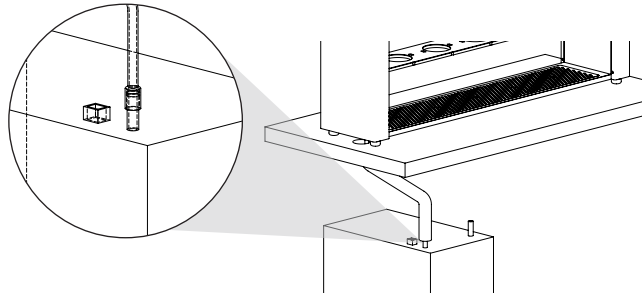

8 Feed circulation tube to drain

- The smaller uninsulated, translucent tubing running from the Poursteady circulates a small amount of water running to the top of the machine, maintaining the water temperature even if it has not been used recently.
- Run this tube to the drain alongside the drain-tube itself.
- Cut to length (if desired).
- Insert the loose end into the drain and secure.

9 Position Wi-Fi adapter or plug-in ethernet cable

- If using the WI-Fi adapter, locate it so that it is out of the way of other plumbing and electrical appliances and within range of the Wi-Fi signal.
- If you are using Ethernet, the Wi-Fi adapter does not need to be installed. Bring the cable through the hole and plug into the Ethernet jack located on the machine.

10 Connect pump control wire

- Plug the connector on the loose end of the pump control wire into matching female connector on the top of the Marco UC Boiler.

11 Turn on Marco UC boiler

- Plug-in water heater and set temperature following Marco's instructions.
- Wait for it to indicate that it is ready.
NOTE: There is typically a 6-8°F (3-5°C) drop from the heater to the nozzle. We recommend 206°F (96°C) on the Marco for 200°F (90°C) water at the nozzle.

12 Plug in and test the Poursteady

- Plug the power supply into the 110V outlet. This will power up the Poursteady.
- Wait until the lights around the buttons flash a few times and the mechanism goes through its homing routine. (about 1 minute)
- Test the machine by making a cup of coffee (refer to page 19)
- Replace the side cover, top cap, and the screws holding them in place.
- You should be ready to go!

POURSTEADY

©2019 – REV 4.0

Network Requirements

The machine can be connected either via onboard Ethernet or an attached WiFi adapter (included).

When using Ethernet, the machine requires no additional user configuration as long as the connected router is a valid gateway and is set up to automatically assign the device an IP address.

WiFi can be enabled with a wireless adapter, and can be configured using the Poursteady local network Access Point with a captive portal.



If there is a firewall, or other rules on the network that would prevent a new device from automatically connecting, we suggest white-listing the device via the MAC address and manually assigning the machine an IP address from your internal configuration settings or router settings.



If you or your organization has particular networking requirements as it relates to the operation of the Poursteady machine, we recommend talking to your network administrator or IT department prior to installation.

Connecting to the Internet

The Poursteady requires an internet connection to create, edit, and assign recipes to your machine. Internet is also required in order to provide periodic firmware updates, perform diagnostics, and additional customer support.

We highly recommend connecting your Poursteady to the internet via an Ethernet connection as it is generally more stable and more secure. However, you can configure your machine to connect via Wi-Fi with the included wireless adapter by following the setup instructions.

We have designed the Poursteady to connect to the internet in the most common network environments. If your network has particular requirements (security or firewalls, router configuration, etc) please consult your IT administrator prior to installing the Poursteady.

Ethernet Setup

Connecting to the Internet via Ethernet is the most secure, and stable way to keep your Poursteady machine online. We recommend whitelisting the Poursteady's MAC address on your network.

1 Connect an ethernet cable

- Ensure the cable is connected to a router with access to the internet.
- Connect an ethernet cable from an open jack on your router to the Poursteady machine.

Wi-Fi configuration and setup

Stability of your wireless network is your responsibility. Our customer support and network of technicians are not qualified to debug your particular network conditions. If you are connecting your machine via Ethernet, please disregard the following instructions.

If the machine is being set up for the first time, or has not connected to any existing Wi-Fi networks, the Poursteady will automatically create an Access-Point (AP), allowing you to connect to it directly by joining the machine's self-created network (further outlined in Step #3).

1 Acquire information about your network and settings

- Make sure you have access to a reliable, secure Wi-Fi network.
- You will need the name of the Wi-Fi network or SSID (case-sensitive) and the password.

2 Power on the machine

- Wait for the machine to complete its startup routine (lights blinking, nozzle moving back and forth).
- Ensure that any previously-connected networks are disabled during the setup or that the machine is out of range of any networks that it shouldn't connect to.

3

Join the “Poursteady-psXXX” network

This will match your machine’s serial number.

- Disconnect your device (cellphone or computer) from your regular Wi-Fi network.
- From your computer or mobile device, search the available Wi-Fi networks or devices and select the network titled “Poursteady-psXXX.”
- When the window pops up with POURSTEADY at the top, you are now connected directly to the Poursteady machine and should proceed to Step 4.

4

Select desired Wi-Fi network

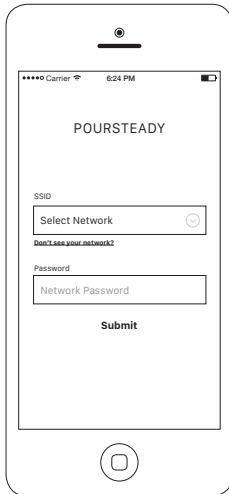

- When prompted, select the Wi-Fi network you want the Poursteady to connect to from the list.
- Enter the password and press “Submit.”
- If you do not see your network in the list, it is likely that the Wi-Fi hardware was not able to see your particular network on it’s initial scan. If you are sure that your network is on and in range, you can:
 - 1) manually entering your network name and password by clicking the “Don’t see your network?” link.
 - 2) unplugging and re-inserting the Wi-Fi adapter, which will take 1-2mins to rescan.

5

Ensure a connection

- If the machine receives the correct network credentials and is able to connect to the internet, you should be able to see it appear in the Poursteady app and on your network.
- If it fails to connect, or successfully reach the internet, it will restart the Poursteady-psXXX access point so that you may re-enter your network.

The Poursteady App

With your Poursteady now connected to the internet, you are ready to create, save and assign recipes on your machine.



The Poursteady must be connected to the internet via a working Wi-Fi network or ethernet connection for changes on the app to take effect.



Accessing the app

- From any browser, either on your mobile device or personal computer, go to my.poursteady.com
- Sign in with your username (email address) and password

NOTE: If you do not have a username and password and are not prompted to register, visit my.poursteady.com/signup and contact Poursteady.



Select a machine

- Once logged in you'll see the Poursteady machines associated with your account, listed with their ID numbers.
- Select the machine that you would like to edit / configure.

3

Creating a recipe

- Select **Recipes** from the bottom menu.
- Select **Create Recipe**, found at the bottom of your list of recipes.
- Enter a name, e.g. “8oz Kenyan”, and tap **Save** in the upper right.
- Follow the steps to define the amount of water, pour patterns, wait times, and number of pours.
- When finished, press save the recipe.
- To test and make changes to a recipe, use the following instructions and repeat.

4

Editing recipes

- From the **Recipes** tab, select the recipe you would like to edit.
- Make your desired changes.
- When changes are recognized, a **Save** button will appear in the upper right corner of the screen.
- When complete, tap or click **Save**. A loading animation will begin.
- Upon successfully receiving these changes, all lights on the machine will flash once.



Changing recipes that are currently assigned to a station on a machine, will update that recipe on every idle station that it is assigned to. For currently busy stations, it will update the recipe on the next active pour.

5 Assign recipes to stations

- Select the “Stations” on the bottom left.
- This will bring up a list of recipes. The list corresponds to the stations on the machine from left to right.
- Tapping any item brings up the list of available Recipes.
- Select one of the available recipes and select “Done”
- Upon successfully receiving these changes, all lights on the machine will flash once.
- Now, at the next pour, the machine will follow the recipe as defined in the app.



Once changes have been downloaded to the machine, they will remain in effect until a new set of changes are made on the app and downloaded to the the Poursteady machine.

If the Poursteady machine is not connected to the internet, it will continue to use the last set of instructions successfully passed to it from the app.

Operation

1 Making a cup of coffee

- Place filter in folder holder
- Press the station button once; this will wet the filter. Once completed the light will blink.
- Prepare grounds, place in filter. Place filter in the selected station.
- Press blinking station button to start the pour.

Learn more on how to configure each station in “The Poursteady App” section.

2 Cancelling a cup of coffee

- Press and hold the station button until the light is no longer on in order to cancel a pour.

3 Purging (pouring hot water)

- Press and hold the button at a station for longer than 3 seconds to pour a steady stream of water

4 Receiving updates from the app

- Upon successfully receiving these changes, all lights on the machine will flash once.

Temperature Control is located on the boiler and cannot be configured with the Poursteady machine.

Maintenance

The Poursteady is designed to require very little maintenance, but please be sure to follow these instructions to keep it running well and looking good.

Daily Cleaning



Do not use any abrasives when cleaning the Poursteady. This may scratch the bare metal finishes.

- Clean all exposed surfaces with a damp cloth and mild detergent.
- Clean the drip tray by removing the cover and thoroughly wiping the tray out with a damp cloth and mild detergent.
- With the drip tray cover removed, use the drain tub brush (supplied) to clean the stainless steel drain fitted into the drip tray. Replace the drip tray cover.
- A stainless steel cleaner applied with a soft, clean towel will help to minimise visible fingerprints and smudges that appear from regular use.

De-scaling

- There are very few parts that actually touch water in the Poursteady machine, and even fewer that are prone to scale building up—especially if the water is being properly filtered.
- We do however recommend de-scaling the Poursteady when you de-scale your boiler. Depending on the quality of your water supply, this can be done as little as once a year.

Troubleshooting

For the most common questions, visit:

poursteady.com/#support

In the event that your machine continues to exhibit problems, contact your Poursteady technician or the Poursteady distributor you purchased this machine from.

Stay in touch

Instagram: @Poursteady

Twitter: @PoursteadyNYC

Facebook: www.facebook.com/Poursteady

Steady Equipment Corporation
Brooklyn Army Terminal
140 58th Street
Building B, Unit 7H-6
Brooklyn, New York 11220

(347) 687-6171
info@poursteady.com
www.poursteady.com