

# Aurelia Wave 3 Group

## Installation Requirements



### Water

- 3/8" dedicated cold water line with shut-off valve and compression fitting.
- Water hardness 3gpg or 50 ppm.
- Line pressure 2-4bar, cold water.
- Water flow rate Minimum 1 GPM
- Filtration  $\leq 1.0$  micron
- TDS 50-250 ppm
- Alkalinity 10-150 ppm
- Chlorine  $\leq 0.50$  ppm
- PH 6.5-8.5

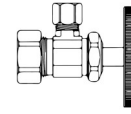

Shut off valve



Nema L6-30  
Twist  
(receptacle)

### Power

- Volts: 220 (range of 208-240)
- Watts: 5400
- Amp draw: 25
- Receptacle: Nema L6-30 Twist

### Drain

- Open gravity drain of minimum 1.25 inch I.D., within 4 feet of the machine.

### Counter Space

- Height: 22 inches
- Depth: 24 inches
- Width: 41 inches

### Countertop Drain Hole Location

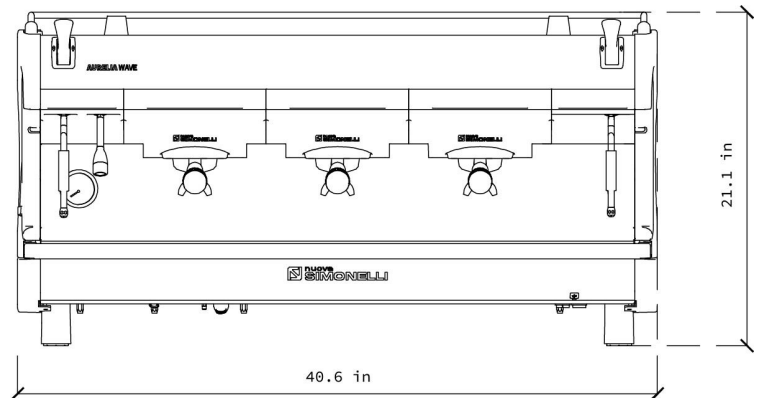
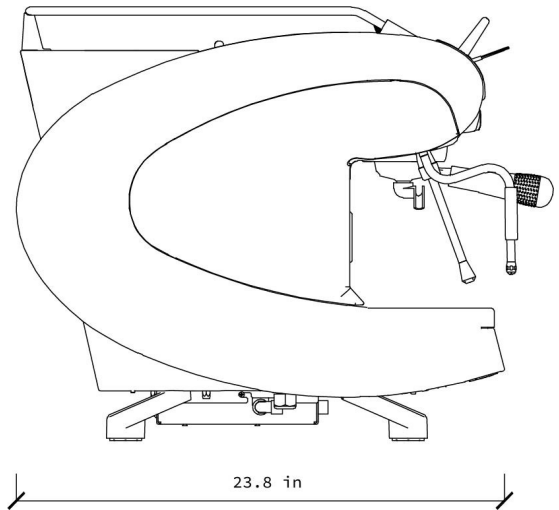
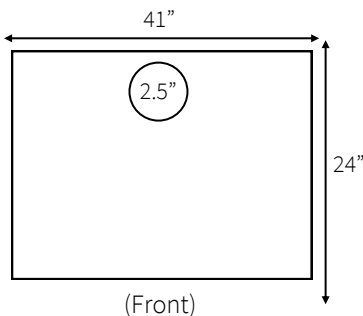

I, the customer, understand that these requirements must be in when the installer arrives. Failure to have the site ready will result in additional service and travel charges, and may cause further delays in installation.

Customer Name: \_\_\_\_\_ Signature: \_\_\_\_\_

Company Name: \_\_\_\_\_

Phone: \_\_\_\_\_ Email: \_\_\_\_\_ Reference number: \_\_\_\_\_