

SPARE PARTS BOOK

APPIA
Life.

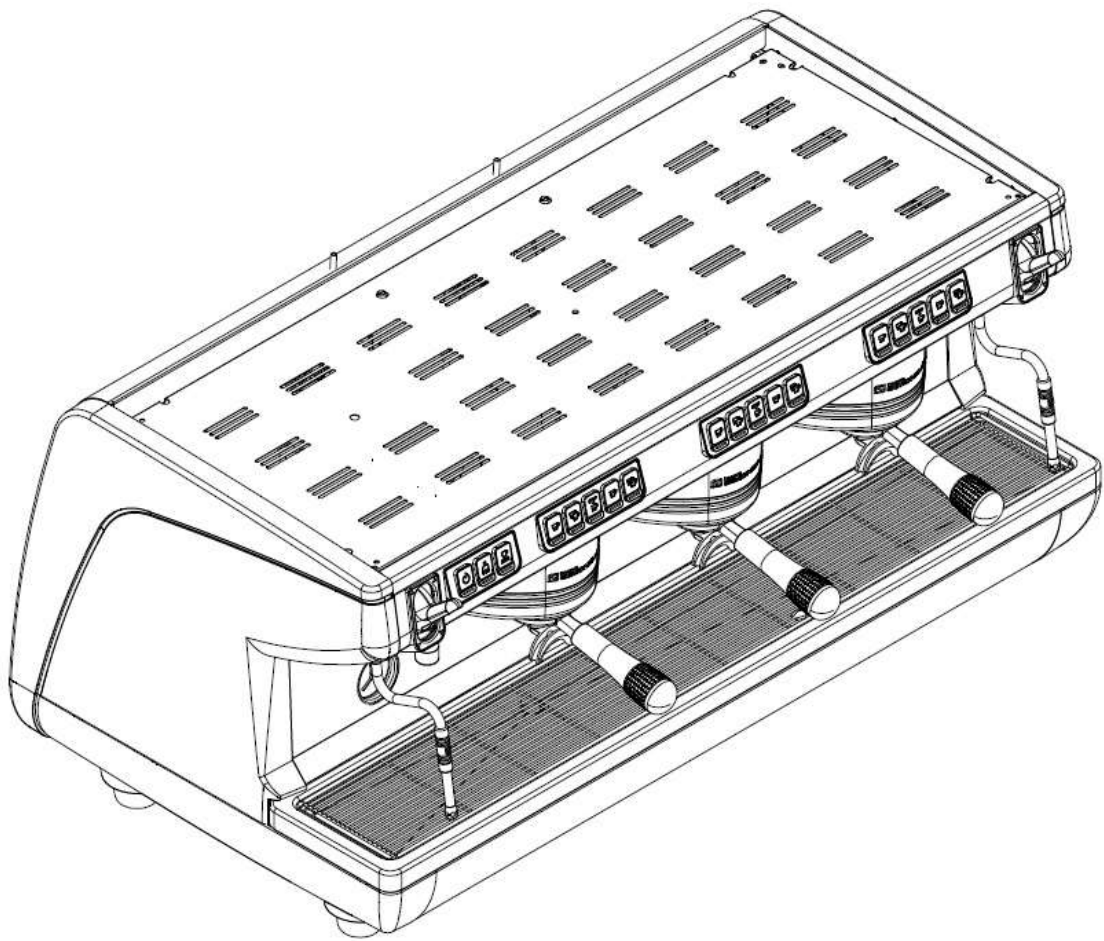

2-3 GR. + XT

23/02/2021

- T.01 **CABINET PARTS**
COMPONENTI GRUPPO CARENA
- T.02 **CONTROL PANEL ASSEMBLY**
ASSIEME PULSANTIERA
- T.03 **POURING UNIT GROUP PARTS**
COMPONENTI GRUPPO EROGAZIONE
- T.04 **HYDRAULIC PARTS**
COMPONENTI IDRAULICI
- T.05 **STEAM TAPS PARTS**
PARTI RUBINETTI VAPORE
- T.06 **HOT WATER TAPS PARTS**
PARTI RUBINETTO ACQUA CALDA
- T.07 **HYDRAULIC GROUP PARTS**
COMPONENTI GRUPPO IDRAULICO
- T.08 **BOILER GROUP PARTS**
COMPONENTI GRUPPO CALDAIA
- T.09 **FRAME PARTS**
COMPONENTI TELAIO
- T.10 **EASYCREAM PARTS**
COMPONENTI EASYCREAM
- T.11 **ELECTRICAL PARTS**
COMPONENTI ELETTRICI
- T.12 **LIGHTS PARTS AND WIFI KIT**
COMPONENTI LUCI E KIT WIFI

» LEGEND :

THE CODES WRITTEN IN BOLD REFER TO THE COMPONENTS
EMPLOYED CURRENTLY.

THE CODES USED BEFORE ARE WRITTEN IN CORSIVE WITH INDICATED,
ON THE SIDE, THE END OF VALIDITY DATE.

EXAMPLE:

03001531 - 01/09/2007

03001531

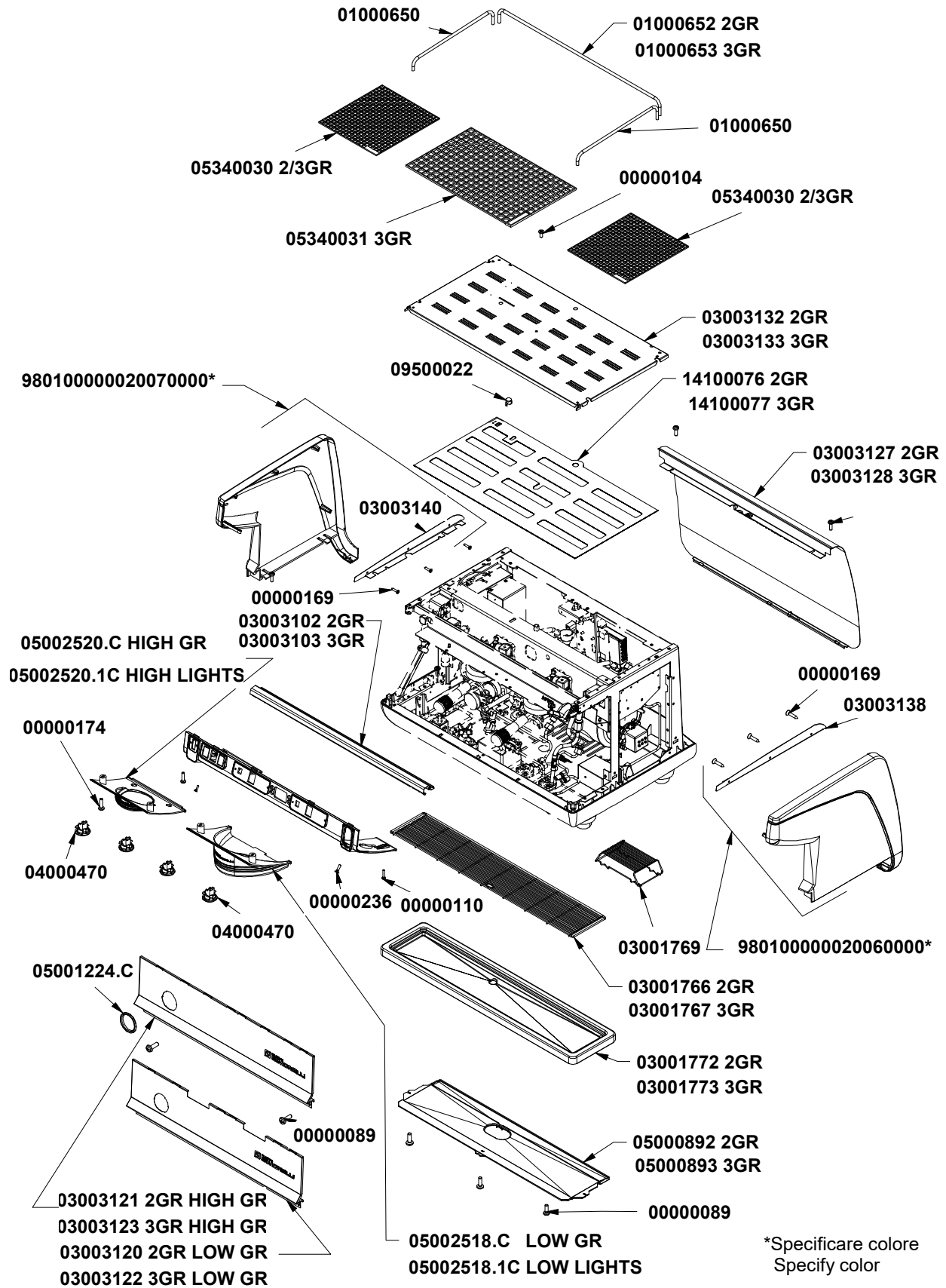

COD.	DESCRIPTION	DESCRIZIONE	VAL.
00000089	S/S CROSSHEAD CAP SCREW M4x12 DIN7985	VITE INOX M4X12 TC TCR DIN7985	
00000104	S/S CROSSHEAD COUNTERSUNK SCREW M4x10 DIN965	VITE INOX M4X10 TSP TCR DIN965	
00000110	S/S CROSS HEAD CAP SCREW M4x20 7985	VITE INOX M4X20 TC T.CR. 7985	
00000169	S/S SELF-TAPPING SCREW 2,9x13 TSP/TCR	VITE AUTOF INOX 2,9X13 TSP/TCR	
00000174	S/S CROSSHEAD CAP SCREW M4x16	VITE INOX M4X16 TC TCR	
00000236	SCREW M4X16 TSP TCR	VITE INOX M4X16 TSP TCR	
01000650	CUPWARMER BACKSIDE TUBE APPIA19	TUBO LATERALE SCALDATAZZE APPIA19	
01000652	CUPWARMER BACKSIDE TUBE APPIA19 2GR	TUBO RETRO SCALDATAZZE APPIA19 2GR.	
01000653	CUPWARMER BACKSIDE TUBE APPIA19 3GR	TUBO RETRO SCALDATAZZE APPIA19 3GR.	
03001766	WORKTOP NET 2 GR	RETINA PIANO LAVORO 2 GR. *KBB*	
R03001766	KIT-WORKTOP NET 2 GR - 1Pcs	KIT-RETINA PIANO LAVORO 2 GR. - 1Pz	
03001767	WORKTOP NET 3 GR	RETINA PIANO LAVORO 3 GR. *KBB*	
03001769	S/S RAISED CUP STAND	SUPP. TAZZINE INOX *KBB*	
R03001769	KIT-S/S RAISED CUP STAND - 1Pcs	KIT-SUPPORTO TAZZINE INOX - 1Pz	
03001772	DRAIN TRAY 2 GR	PIATTO RACCOGLIACQUA 2 GR. * KBB *	
03001773	DRAIN TRAY 3 GR	PIATTO RACCOGLIACQUA 3 GR.	
03003102	COMAND BUTTON WRAPPING 2GR	INVOLUCRO COMANDI 2GR APPIA19	
03003103	COMAND BUTTON WRAPPING 3GR	INVOLUCRO COMANDI 3GR APPIA19	
03003120	FRONTAL PANEL LOW 2GR APPIA19	PARETE FRONTALE GR.BASSI 2GR. APPIA19	
03003121	FRONTAL PANEL RAISED 2GR APPIA19	PARETE FRONTALE GR.ALT 2GR. APPIA19	
03003122	FRONTAL PANEL LOW 3GR APPIA19	PARETE FRONTALE GR.BASSI 3GR. APPIA19	
03003123	FRONTAL PANEL RAISED 3GR APPIA19	PARETE FRONTALE GR.ALT 3GR. APPIA19	
03003127	REAR COVER 2GR	CARENA RETRO 2GR.	
03003128	REAR COVER 3GR	CARENA RETRO 3GR.	
03003132	CUP HOLDER PLATE 2GR	PIATTO PORTATAZZE 2GR	
03003133	CUP HOLDER PLATE 3GR	PIATTO PORTATAZZE 3GR	
03003138	UPPER PLATE RIGHT SIDE	MOSTRINA SUP. FIANCO DX	
03003140	UPPER PLATE LEFT SIDE	MOSTRINA SUP. FIANCO SX	
05002518.1C	GROUP COVER LOW GR APPIA19 W/LOGO for LIGHTS CH	COPRIGRUPPO GR. BASSO APPIA19 CON LOGO PER LUCI C	
05002520.1C	GROUP COVER RAISED GR APPIA19 W/LOGO-LIGHTS CH	COPRIGRUPPO GR. ALTO APPIA19 CON LOGO PER LUCI C	
04000470	12VDC LED SPOT AURELIA WAVE	LED AURELIA18 12V	
05000892	SAFETY COVER WORKTOP 2 ABS	CHIUSURA SICUR. PIANO LAVORO 2 ABS *KBB*	
R05000892	KIT-SAFETY COVER WORKTOP 2 ABS - 1Pcs	KIT-CHIUSURA SICUR. PIANO LAVORO 2 ABS - 1Pz	
05000893	SAFETY COVER WORKTOP 3 ABS	CHIUSURA SICUR. PIANO LAVORO 3 ABS *KBB*	
R05000893	KIT-SAFETY COVER WORKTOP 3 ABS - 1Pcs	KIT-CHIUSURA SICUR. PIANO LAVORO 3 ABS - 1Pz	
05001224.C	WATER GAUGE PLATE AURELIA II CHROME	MOSTRINA MANOMETRO AURELIA II CROMATA	
05002518.C	GROUP COVER LOW GR APPIA19 W/LOGO CHROME	COPRIGRUPPO GR. BASSO APPIA19 CON LOGO CROMATO	
05002520.C	GROUP COVER RAISED GR APPIA19 W/LOGO CHROME	COPRIGRUPPO GR. ALTO APPIA19 CON LOGO CROMATO	
05340030	NYLON GRILL 370x335	GRIGLIA MODULO 370X335	
R05340030	KIT-NYLON GRILL 370x335 - 2Pcs	KIT-GRIGLIA MODULO 370x335 - 2Pz	
05340031	NYLON GRILL 370x230	GRIGLIA MODULO 370X230	
R05340031	KIT-NYLON GRILL 370x230 - 2Pcs	KIT-GRIGLIA MODULO 370x230 - 2Pz	
09500022	AUTOMATIC THERMOSTAT 75°C BROWN DRIPPING	TERMOSTATO R.AUT. 75°C GOCCIOLATURA MARRONE	
14100076	ADHESIVE SILICONE HEATING ELEMENT-CUPWARMER 2	RESISTENZA ADESIVA SCALDATAZZE 2GR.	
14100077	ADHESIVE SILICONE HEATING ELEMENT-CUPWARMER 3	RESISTENZA ADESIVA SCALDATAZZE 3GR.	

APP
Life.

2-3 GR + XT

2-3 GR + XT

COMPONENTI GRUPPO CARENA

CABINET PARTS

COD.	DESCRIPTION	DESCRIZIONE	VAL.
980100000020060001	RIGHT SIDE PANEL SET BLACK	ASS. FIANCO DX NERO	
980100000020060002	RIGHT SIDE PANEL SET WHITE	ASS. FIANCO DX BIANCO	
980100000020060003	RIGHT SIDE PANEL SET RED	ASS. FIANCO DX ROSSO	
980100000020060004	RIGHT SIDE PANEL SET MATT BLACK	ASS. FIANCO DX NERO OPACO	
980100000020070001	LEFT SIDE PANEL SET BLACK	ASS. FIANCO SX NERO	
980100000020070002	LEFT SIDE PANEL SET WHITE	ASS. FIANCO SX BIANCO	
980100000020070003	LEFT SIDE PANEL SET RED	ASS. FIANCO SX ROSSO	
980100000020070004	LEFT SIDE PANEL SET MATT BLACK	ASS. FIANCO SX NERO OPACO	

APP
Life.

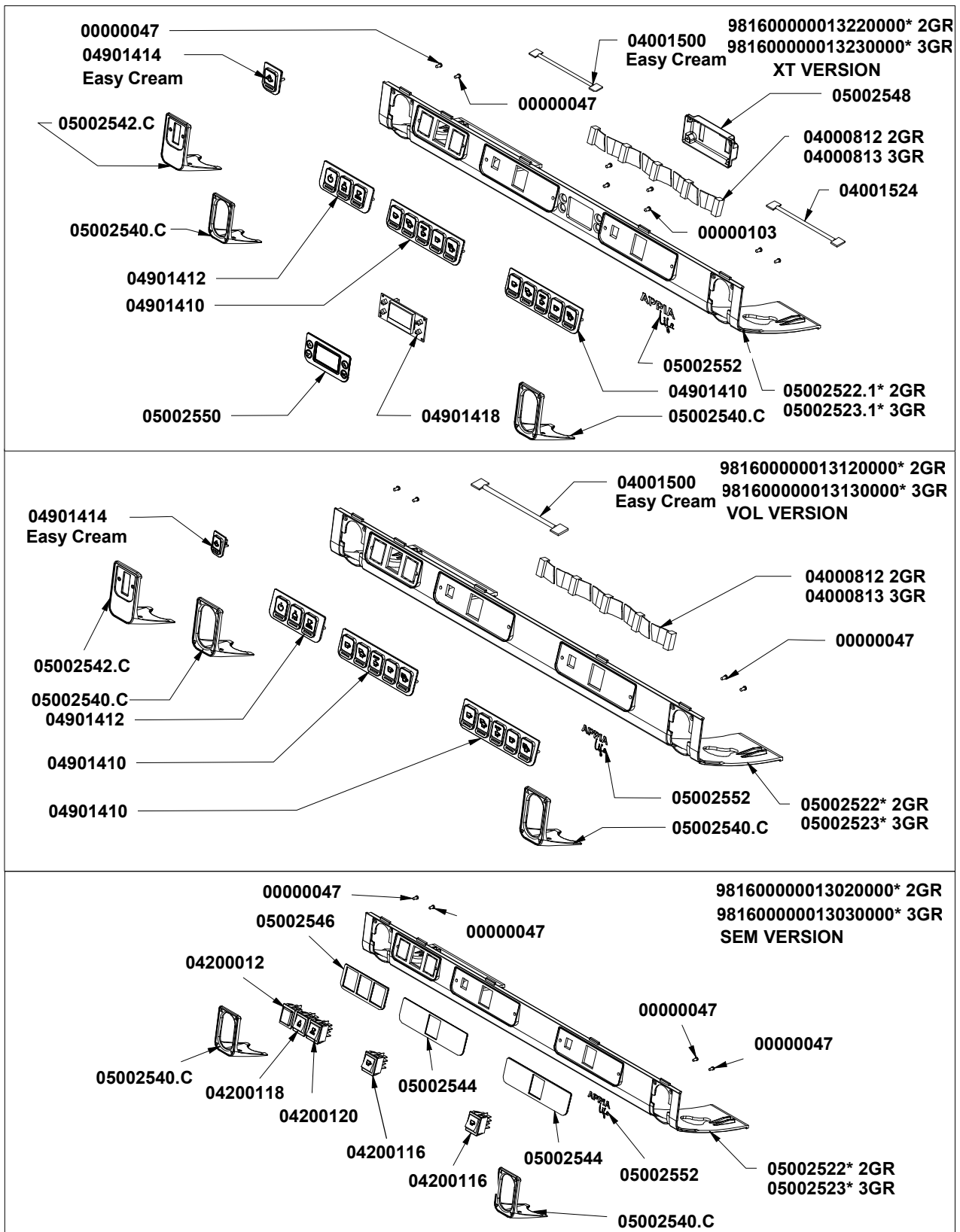

* Specificare versione
Specify version

COD.	DESCRIPTION	DESCRIZIONE	VAL.
00000047	CROSS HEAD/CAP SELF-TAPPING SCREW 2,9x6,5	VITE AUTOF 2,9X6,5 TC/T.CR.	
00000103	GALV SELF-TAPP. CROSS HEAD CAP SCREW 3.9x6.5	VITE AUTOF 3,9X6,5 TC T.CR.ZIN	
04000812	CABLE 14 WAY KEYPAD 2GR APPIA + SHEATH	CAVO 14 VIE COLL.PULSANTIERA 2GR APPIA + GUAINA	
R04000812	KIT-CABLE 14 WAY KEYPAD 2GR + SHEATH - 2Pcs	KIT-CAVO 14 VIE COLL.PULSANTIERA 2GR - 2Pz	
04000813	CABLE 14 WAY KEYPAD 3GR APPIA + SHEATH	CAVO 14 VIE COLL.PULSANTIERA 3GR APPIA + GUAINA	
R04000813	KIT-CABLE 14 WAY KEYPAD 3GR + SHEATH - 2Pcs	KIT-CAVO 14 VIE COLL.PULSANTIERA 3GR - 2Pz	
04001500	EASYCREAM BUTTON-MAIN BOARD CONNECTION CABLE	CAVO COLL. TASTO REMOTO - CENTRALINA EASY CREAM	
04001524	CONN CABLE DISPLAY-CENTRAL BOARD APPIA19	CAVO COLL. DISPLAY-CENTRALINA APPIA19	
04200012	RED FLASHING SEGNA SYSTEM UL	SEGNALATORE LUMINOSO ROSSO RETTANGOLARE UL	
04200116	BLUE LIGHT WHITE BIPOLAR SWITCH UL 16A COFFEE	INTERRUTTORE BIPOLARE LUMINOSO BIANCO RETTANGOLARE UL	
04200118	BLUE LIGHT WHITE BIPOLAR SWITCH UL 16A HOTWATER	INTERRUTTORE BIPOLARE LUMINOSO BIANCO RETTANGOLARE UL	
04200120	BLUE LIGHT WHITE BIPOLAR SWITCH UL 16A CUPWARM	INTERRUTTORE BIPOLARE LUMINOSO BIANCO RETTANGOLARE UL	
04901410	5KEY DISPENSING KEYPAD APPIA19 V	SCHEDA EROG. 5 TASTI APPIA19 V	
04901412	3KEY DISPENSING KEYPAD APPIA19 V	SCHEDA SERV. 3 TASTI APPIA19 V	
04901414	STEAM DISPENSING KEY APPIA19 V	SCHEDA EROGAZ. 1 TASTO VAPORE APPIA19 V	
04901418	DISPLAY BOARD APPIA19 XT	SCHEDA DISPLAY APPIA19 XT	
05002522.N	KEYPAD 2GR APPIA19 BLACK	PULSANTIERA 2GR. APPIA19 NERO	
05002522.NOV	KEYPAD 2GR APPIA19 PAINTED MATTE BLACK	PULSANTIERA 2GR. APPIA19 NERO OPACO VERNICIATO	
05002522.RV	KEYPAD 2GR APPIA19 PAINTED RED	PULSANTIERA 2GR. APPIA19 ROSSO VERNICIATO	
05002522.1BV	KEYPAD 2GR APPIA19 W/ DISPL. OPENING PAINTED WHITE	PULSANTIERA 2GR. APPIA19 CON APERTURA DISPLAY BIANCA	
05002522.1NOV	KEYPAD 2GR APPIA19 W/DISPL OPENING PAINT MATTE BLACK	PULSANTIERA 2GR. APPIA19 CON APERTURA DISPLAY NERA	
05002522.1RV	KEYPAD 2GR APPIA19 W/DISPLAY OPENING PAINTED RED	PULSANTIERA 2GR. APPIA19 CON APERTURA DISPLAY ROSSA	
05002523.BV	KEYPAD 3GR APPIA19 PAINTED WHITE	PULSANTIERA 3GR. APPIA19 BIANCO VERNICIATO	
05002523.NOV	KEYPAD 3GR APPIA19 PAINTED MATTE BLACK	PULSANTIERA 3GR. APPIA19 NERO OPACO VERNICIATO	
05002523.RV	KEYPAD 3GR APPIA19 PAINTED RED	PULSANTIERA 3GR. APPIA19 ROSSO VERNICIATO	
05002523.1BV	KEYPAD 3GR APPIA19 W/DISPLAY OPENING PAINTED WHITE	PULSANTIERA 3GR. APPIA19 CON APERTURA DISPLAY BIANCA	
05002523.1NOV	KEYPAD 3GR APPIA19 W/DISPLAY OPENING PAINTED MATTE BLACK	PULSANTIERA 3GR. APPIA19 CON APERTURA DISPLAY NERA	
05002523.1RV	KEYPAD 3GR APPIA19 W/DISPLAY OPENING PAINTED RED	PULSANTIERA 3GR. APPIA19 CON APERTURA DISPLAY ROSSA	
05002540.C	APPIA19 STEAM KNOB CHROME PLATED COVER	MOSTRINA MANOPOLA VAPORE APPIA19 CROMATA	
05002542.C	APPIA19 EASYCREAM CHROME PLATED COVER	MOSTRINA PULSANTE EASY CREAM APPIA19 CROMATA	
05002544	DISPENSING KEY TAB S	MOSTRINA TASTO EROG. S	
05002546	SERVICE KEYS TAB S	MOSTRINA TASTI SERV. S	
05002548	CLOSING DISPLAY CARD V	CHIUSURA SCHEDA DISPLAY V	
05002550	FILM BUTTONS DISPLAY CARD V	PELLICOLA PULSANTI SCHEDA DISPLAY V	
05002552	APPIA LIFE ADHESIVE CHROME PLATED LABEL METALFLEX	ETICHETTA AD "APPIA LIFE" METALFLEX CROMO	
981600000013020001	PUSHBUTTON PANEL ASSEMBLY 2GR SEM BLACK	ASS. PULSANT. COMP. 2GR SEM NERO	
981600000013020002	PUSHBUTTON PANEL ASSEMBLY 2GR SEM WHITE	ASS. PULSANT. COMP. 2GR SEM BIANCO	
981600000013020003	PUSHBUTTON PANEL ASSEMBLY 2GR SEM RED	ASS. PULSANT. COMP. 2GR SEM ROSSO	
981600000013020004	PUSHBUTTON PANEL ASSEMBLY 2GR SEM MATT BLACK	ASS. PULSANT. COMP. 2GR SEM NERO OPACO	
981600000013030001	PUSHBUTTON PANEL ASSEMBLY 3GR SEM MATT BLACK	ASS. PULSANT. COMP. 3GR SEM NERO	
981600000013030002	PUSHBUTTON PANEL ASSEMBLY 3GR SEM WHITE	ASS. PULSANT. COMP. 3GR SEM BIANCO	
981600000013030003	PUSHBUTTON PANEL ASSEMBLY 3GR SEM RED	ASS. PULSANT. COMP. 3GR SEM ROSSO	
981600000013120001	PUSHBUTTON PANEL 2GR VOL BLACK	ASS. PULSANT.COMP. 2GR VOL NERO	
981600000013120002	PUSHBUTTON PANEL 2GR VOL WHITE	ASS. PULSANT.COMP. 2GR VOL BIANCO	
981600000013120003	PUSHBUTTON PANEL 2GR VOL RED	ASS. PULSANT.COMP. 2GR VOL ROSSO	

COD.	DESCRIPTION	DESCRIZIONE	VAL.
98160000013120004	PUSHBUTTON PANEL 2GR VOL EC RIGHT BLACK	ASS. PULSANT.COMP. 2GR VOL EASY CREAM DX NERO	
98160000013120005	PUSHBUTTON PANEL 2GR VOL EC RIGHT WHITE	ASS. PULSANT.COMP. 2GR VOL EASY CREAM DX BIANCO	
98160000013120006	PUSHBUTTON PANEL 2GR VOL EC RIGHT RED	ASS. PULSANT.COMP. 2GR VOL EASY CREAM DX ROSSO	
98160000013120007	PUSHBUTTON PANEL 2GR VOL EC LEFT BLACK	ASS. PULSANT.COMP. 2GR VOL EASY CREAM SX NERO	
98160000013120008	PUSHBUTTON PANEL 2GR VOL EC LEFT WHITE	ASS. PULSANT.COMP. 2GR VOL EASY CREAM DX BIANCO	
98160000013120009	PUSHBUTTON PANEL 2GR VOL EC LEFT RED	ASS. PULSANT.COMP. 2GR VOL EASY CREAM SX ROSSO	
98160000013120010	PUSHBUTTON PANEL 2GR VOL TURBO CREAM LEFT BLA	ASS. PULSANT.COMP. 2GR VOL TURBO CREAM SX NERO	
98160000013120011	PUSHBUTTON PANEL 2GR VOL MATT BLACK	ASS. PULSANT.COMP. 2GR VOL NERO OPACO	
98160000013120012	PUSHBUTTON PANEL 2GR VOL EC RIGHT MATT BLACK	ASS. PULSANT.COMP. 2GR VOL EASY CREAM DX NERO O	
98160000013120013	PUSHBUTTON PANEL 2GR VOL EC LEFT MATT BLACK	ASS. PULSANT.COMP. 2GR VOL EASY CREAM SX NERO OI	
98160000013130001	PUSHBUTTON PANEL 3GR VOL MATT BLACK	ASS. PULSANT.COMP. 3GR VOL NERO OPACO	
98160000013130002	PUSHBUTTON PANEL 3GR VOL WHITE	ASS. PULSANT.COMP. 3GR VOL BIANCO	
98160000013130003	PUSHBUTTON PANEL 3GR VOL RED	ASS. PULSANT.COMP. 3GR VOL ROSSO	
98160000013130004	PUSHBUTTON PANEL 3GR VOL EC RIGHT MATT BLACK	ASS. PULSANT.COMP. 3GR VOL EC DX NERO OPACO	
98160000013130005	PUSHBUTTON PANEL 3GR VOL EC RIGHT WHITE	ASS. PULSANT.COMP. 3GR VOL EC DX BIANCO	
98160000013130006	PUSHBUTTON PANEL 3GR VOL EC RIGHT RED	ASS. PULSANT.COMP. 3GR VOL EC DX ROSSO	
98160000013220001	PUSHBUTTON PANEL 2GR XT MATT BLACK	ASS. PULSANT.COMP. 2GR XT NERO OPACO	
98160000013220002	PUSHBUTTON PANEL 2GR XT WHITE	ASS. PULSANT.COMP. 2GR XT BIANCO	
98160000013220003	PUSHBUTTON PANEL 2GR XT RED	ASS. PULSANT.COMP. 2GR XT ROSSO	
98160000013220004	PUSHBUTTON PANEL 2GR XT EC RIGHT WHITE	ASS. PULSANT.COMP. 2GR XT EASY CREAM DX BIANCO	
98160000013220005	PUSHBUTTON PANEL 2GR XT EC RIGHT RED	ASS. PULSANT.COMP. 2GR XT EASY CREAM DX ROSSO	
98160000013220006	PUSHBUTTON PANEL 2GR XT EC RIGHT MATT BLACK	ASS. PULSANT.COMP. 2GR XT EASY CREAM DX NERO OP.	
98160000013220007	PUSHBUTTON PANEL 2GR XT EC LEFT WHITE	ASS. PULSANT.COMP. 2GR XT EASY CREAM SX BIANCO	
98160000013220008	PUSHBUTTON PANEL 2GR XT EC LEFT RED	ASS. PULSANT.COMP. 2GR XT EASY CREAM SX ROSSO	
98160000013220009	PUSHBUTTON PANEL 2GR XT EC LEFT MATT BLACK	ASS. PULSANT.COMP. 2GR XT EASY CREAM SX NERO OP,	
98160000013230001	PUSHBUTTON PANEL 3GR XT MATT BLACK	ASS. PULSANT.COMP. 3GR XT NERO OPACO	
98160000013230002	PUSHBUTTON PANEL 3GR XT WHITE	ASS. PULSANT.COMP. 3GR XT BIANCO	
98160000013230003	PUSHBUTTON PANEL 3GR XT RED	ASS. PULSANT.COMP. 3GR XT ROSSO	
98160000013230004	PUSHBUTTON PANEL 3GR XT RIGHT EC WHITE	ASS. PULSANT.COMP. 3GR XT EC DX BIANCO	
98160000013230005	PUSHBUTTON PANEL 3GR XT RIGHT EC RED	ASS. PULSANT.COMP. 3GR XT EC DX ROSSO	
98160000013230006	PUSHBUTTON PANEL 3GR XT RIGHT EC MATT BLACK	ASS. PULSANT.COMP. 3GR XT EC DX NERO OPACO	
98160000013230007	PUSHBUTTON PANEL 3GR XT LEFT EC WHITE	ASS. PULSANT.COMP. 3GR XT EC SX NERO OPACO	

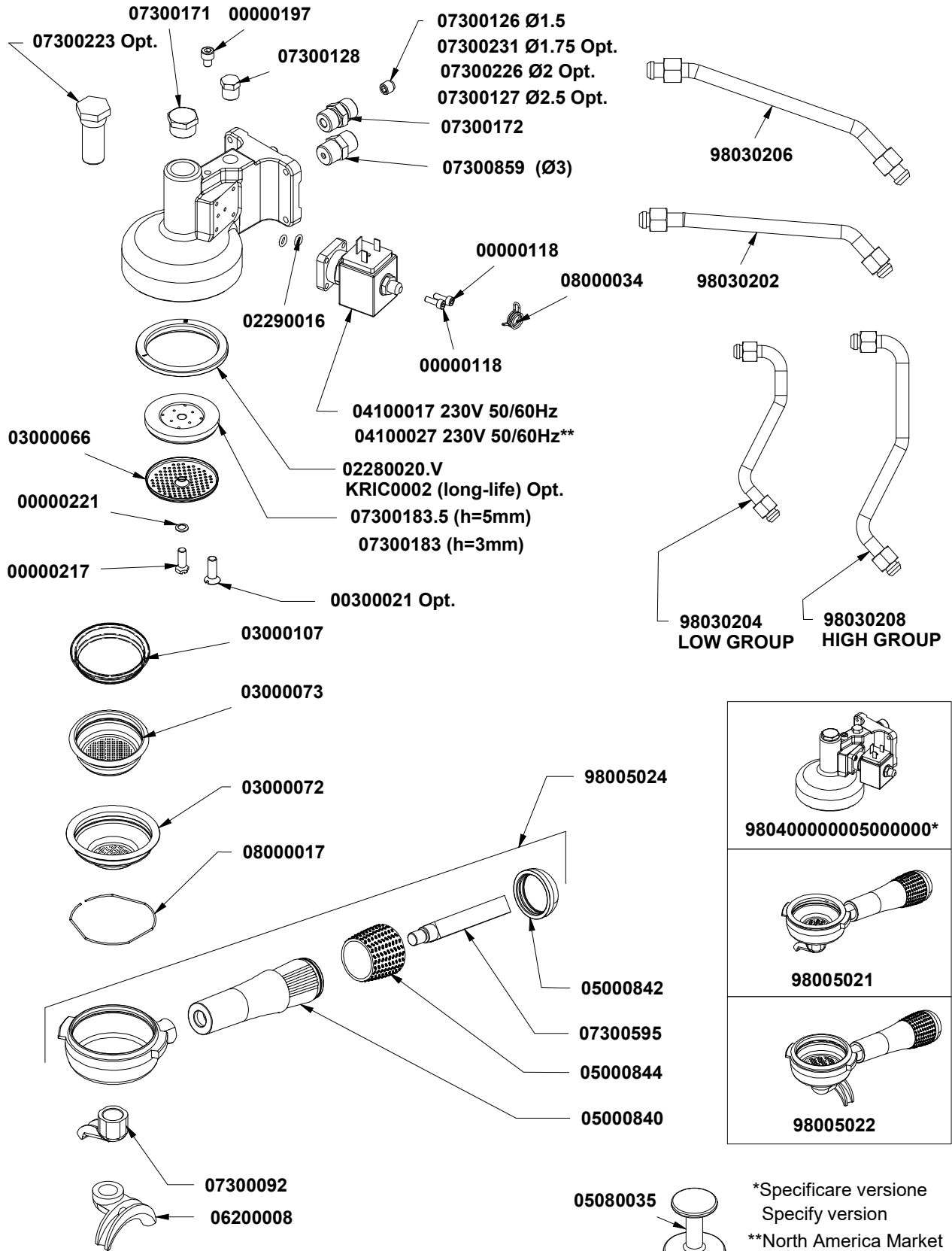

*Specificare versione
Specify version

**North America Market
Mercato Nord America

COD.	DESCRIPTION	DESCRIZIONE	VAL.
00000118	S/SHEX SOCKET CAP SCREW M4x12 5931	VITE INOX M4X12 TCEI 5931	
00000197	S/S HEX SOCKET CAP SCREW M6x8 ISO 4762	VITE INOX M6X8 TCEI ISO 4762	
00000217	S/S SCREW TE CH9 + TC LT=20 FOR SHOWER	VITE INOX M6 LT=20 TE CH9 + TCX DOCCIA	
R00000217	KIT-S/S SCREW TE CH9 + TC LT=20 FOR SHOWER - 10Pcs	KIT-VITE INOX M6 LT=20 + TCx DOCCIA - 10Pz	
00000221	S/S SECURITY FLAT WASHER INOX M6 CONICAL	RONDELLA DI SICUREZZA INOX M6 SCHNORR CONICA	
00300021	S/S SLT COUNTERSUNK SCREW M6X18 DIN963	VITE INOX M6X18 TSP TC DIN963	
R00300021	KIT-S/S SLT COUNTERSUNK SCREW M6X18 - 30Pcs	KIT-VITE INOX M6x18 - 30Pz	
02280020.V	CONICAL GROUP GASKET	GUARNIZ. SOTTOCOPPA CONICA H7.8 V - NBR 82/84 SHA	
R02280020.V	KIT-CONICAL GROUP GASKET - 10Pcs	KIT-GUARNIZ. SOTTOCOPPA CONICA H7.8 V - NBR- 10Pz	
02290016	GASKET O RING D9,5 R5 SIL RED	GUARN. OR D 9,5 R5 SILICONE R.	
R02290016	KIT-GASKET O RING D9,5 SIL RED - 30Pcs	KIT-GUARN. OR D 9,5 SILICONE R. - 30Pz	
03000066	S/S SHOWER 56X5,5X6 WELDED	DOCCIA INOX 56X5,5X 6 SALDATA AISI304	
R03000066	KIT-S/S SHOWER 56X5,5X6 WELDED - 5Pcs	KIT-DOCCIA INOX 56x5,5x 6 SALDATA Aisi304 - 5Pz	
03000072	FILTER ONE COFFEE HIGH 7gr	FILTRO 1 CAFFE' ALTO 7GR.	
R03000072	KIT-FILTER ONE COFFEE HIGH 7gr - 3Pcs	KIT-FILTRO 1 CAFFE' ALTO 7gr. - 3Pz	
03000073	FILTER TWO COFFEE HIGH 14gr	FILTRO 2 CAFFE' ALTO 14GR.	
R03000073	KIT-FILTER TWO COFFEE HIGH 14gr - 3Pcs	KIT-FILTRO 2 CAFFE' ALTO 14gr. - 3Pz	
03000107	BLIND FILTER	FILTRO CIECO	
R03000107	KIT-BLIND FILTER - 8Pcs	KIT-FILTRO CIECO - 8Pz	
04100017	3WAY SOLENOID DIS BASE 1/8 220-230V 50/60Hz CE	E.V. NC 3VIE BASETTA SCAR. 1/8 220-230V 50/60HZ CE	
R04100017	KIT-3WAY SOLENOID DIS BASE 1/8220-230V50/60Hzz - 1F	KIT-E.V. NC 3VIE BASETTA SCAR. 1/8220-230V 50/60HZ- 1Pz	
04100027	3WAY SOLENOID DIS BASE 1/8 208-240V 60Hz F1.3 UL	E.V. NC 3VIE BASETTA SCAR. 1/8208-240V 60HZ RUBY F1.3	
05000840	FILTER HOLDER KNOB 2003 BLACK	MANOPOLA PORTAFILTRO 2003 NERO*KBB*	
05000842	FILTER HOLDER KNOB LOCK 2003	CHIUSURA MANOPOLA PORTAFILTRO 2003 *KBB*	
R05000842	KIT-FILTER HOLDER KNOB LOCK - 20Pcs	KIT-CHIUSURA MANOPOLA PORTAFILTRO - 20Pz	
05000844	BLACK RUBBER COVER FILTER HOLDER KNOB	RIVESTIMENTO GOMMA NERA MANOPOLA PORTAFILTRO	
05080035	COFFEE TAMPER ABS BLACK	PRESSA CAFFE' ABS NERO	
06200008	2WAY OPEN NOZZLE	BECCO DUE VIE OPEN	
R06200008	KIT-2WAY OPEN NOZZLE - 1Pcs	KIT-BECCO DUE VIE OPEN - 1Pz	
07300092	1WAY CURVED OPEN NOZZLE	BECCO UNA VIA CURVO OPEN	
R07300092	KIT-1WAY CURVED OPEN NOZZLE - 2Pcs	KIT-BECCO UNA VIA CURVO OPEN - 2Pz	
07300126	GIGLEUR M8x8 F.1,5 OT-57 +TEA	GIGLER M8X8 F.1,5 OT-57 +TEA	
07300127	GIGLEUR M8x8 F.2,5	GIGLER M8X8 F.2,5	
07300128	PLUG 1/4 GAS	TAPPO 1/4 GAS OT-57	
07300171	DISPENSING GROUP PLUG OT M20X1,5	TAPPO OT M20X1,5 GR. EROG.	
07300172	FITTING 3/8"M-3/8"M INT M8 OT-57 USA	RACCORDO 3/8"M-3/8"M INT M8 OT-57 USA	
R07300172	KIT-FITTING 3/8"M-3/8"M INT M8 USA - 8Pcs	KIT-RACCORDO 3/8"M-3/8"M INT M8 - 8Pz	
07300183	GROUP DIFFUSER h=3 OT-57	PADIGLIONE GRUPPO H=3 OT-57	
R07300183	KIT-GROUP DIFFUSER h=3 - 2Pcs	KIT-PADIGLIONE GRUPPO h=3 - 2Pz	
07300183.5	GROUP DIFFUSER h=5 OT-58	PADIGLIONE GRUPPO H=5 OT-58	
R07300183.5	KIT-GROUP DIFFUSER h=5 - 2Pcs	KIT-PADIGLIONE GRUPPO h=5 - 2Pz	
07300223	INFUSION CHAMBER COVER PLUG PREMIER GR	TAPPO CHIUS. CAMERA INFUSIONE GR. PREMIER	
07300226	GIGLEUR M8X8 F.2 OT-57 + TEA	GIGLER M8X8 F.2,0 OT-57 +TEA	
07300231	GIGLEUR M8X8 F.1,8	GIGLER M8X8 F.1,8	
07300595	PORTAFILTER KNOB INSERT 2003 AVP ZINC.	INSERTO MANOPOLA PORTAFILTRO 2003 AVP ZINC.	

COD.	DESCRIPTION	DESCRIZIONE	VAL.
07300859	FITTING 3/8M-3/8M GIGLER F.3 OT-57	RACCORDO 3/8M-3/8M GIGLER F.3 OT-57	
08000017	S/S FILTER LOCKING SPRING	MOLLA BLOCCA FILTRO ACC.INOX	
R08000017	KIT-S/S FILTER LOCKING SPRING - 15Pcs	KIT-MOLLA BLOCCA FILTRO ACC.INOX - 15Pz	
08000034	HOSE CLAMP D12	FASCETTA STRINGITUBO D12	
98005021	COMPLETE SLOPED PORTAFILTER 1WAY N.S.	PORTAFILTRO INCLINATO COMP. 1 VIA N.S. *KBB*	
R98005021	KIT-COMPLETE SLOPED PORTAFILTER 1WAY N.S. - 1Pcs	KIT-PORTAFILTRO INCLINATO COMP. 1 VIA N.S. - 1Pz	
98005022	COMPLETE SLOPED PORTAFILTER 2WAY N.S.	PORTAFILTRO INCLINATO COMP. 2 VIE N.S.*KBB*	
R98005022	KIT-COMPLETE SLOPED PORTAFILTER 2WAY N.S. - 1Pcs	KIT-PORTAFILTRO INCLINATO COMP. 2 VIE N.S. - 1Pz	
98005024	SLOPED PORTAFILTER BODY + N.S. HANDLE	CORPO PORTAFILTRO INCLINATO + MANOPOLA N.S. *KBB	
98030202	SUPERIOR TUBE 3/8 3/8 LOW GR APPIA 2-3GR	TUBO SUP. 3/8 3/8 GR.BASSO APPIA 2-3 GR.	
R98030202	KIT-SUPERIOR TUBE 3/8 3/8 LOW GR - 2Pcs	KIT-TUBO SUP. 3/8 3/8 GR.BASSO - 2Pz	
98030204	INFERIOR TUBE 3/8 3/8 LOW GR APPIA 2-3GR	TUBO INF. 3/8 3/8 GR.BASSO APPIA 2-3 GR.	
R98030204	KIT-INFERIOR TUBE 3/8 3/8 LOW GR - 2Pcs	KIT-TUBO INF. 3/8 3/8 GR.BASSO - 2Pz	
98030206	SUPERIOR TUBE 3/8 3/8 RAISED GR APPIA 2-3GR	TUBO SUP. 3/8 3/8 GR. ALTO APPIA 2-3 GR.	
R98030206	KIT-SUPERIOR TUBE 3/8 3/8 RAISED GR - 2Pcs	KIT-TUBO SUP. 3/8 3/8 GR. ALTO - 2Pz	
98030208	INFERIOR TUBE 3/8 3/8 RAISED GR APPIA 2-3GR	TUBO INF.3/8 3/8 GR.ALTO APPIA 2-3 GR.	
R98030208	KIT-INFERIOR TUBE 3/8 3/8 RAISED GR - 1Pcs	KIT-TUBO INF.3/8 3/8 GR.ALTO - 1Pz	
98040000005000001	DISPENSING GROUP SET 220-240V 380V 50/60Hz	ASS. GR. EROG. 220-240V 380V 50/60Hz	
98040000005000002	DISPENSING GROUP SET CE 380V TRI	ASS. GR. EROG. CE 380V TRI	
98040000005000003	DISPENSING GROUP SET CE 208-240V 60Hz	ASS. GR. EROG. CE 208-240V 60Hz	
98040000005000004	DISPENSING GROUP SET ETI - KC 208-240V 60Hz	ASS. GR. EROG. ETI - KC 208-240V 60Hz	
98040000005000005	DISPENSING GROUP SET 110-120V 60Hz	ASS. GR. EROG. 110-120V 60Hz	
98040000005000006	DISPENSING GROUP SET TL/CSA 208-240V 60Hz	ASS. GR. EROG. TL/CSA 208-240V 60Hz	
98040000005000007	DISPENSING GROUP SET CC 220-230V 50Hz	ASS. GR. EROG. CC 220-230V 50Hz	
98040000005000008	DISPENSING GROUP SET INMETRO 208-240V 60Hz	ASS. GR. EROG. INMETRO 208-240V 60Hz	
98040000005000009	DISPENSING GROUP SET IRAM 220-230V 50Hz	ASS. GR. EROG. IRAM 220-230V 50Hz	
98040000005000010	DISPENSING GROUP SET CSA 110-120V 60Hz	ASS. GR. EROG. CSA 110-120V 60Hz	
98040000005000011	DISPENSING GROUP SET CE 220-240V 50-60Hz	ASS. GR. EROG. CE 220-240V 50-60Hz	
KRIC0002	6pc PK LONGLIFE CONICAL GASKET SHEATH MUSICA-AF	CONFEZIONE 6PZ. GUARNIZIONE SOTTOCOPPA CONICA I	

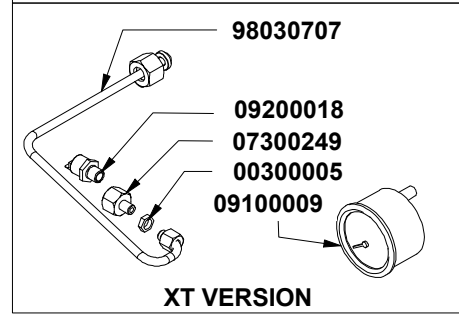
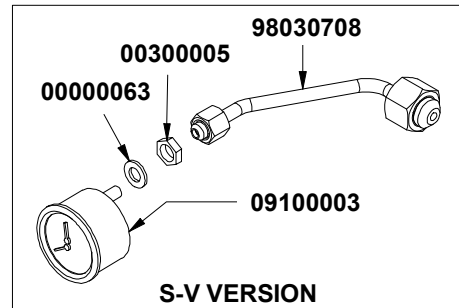
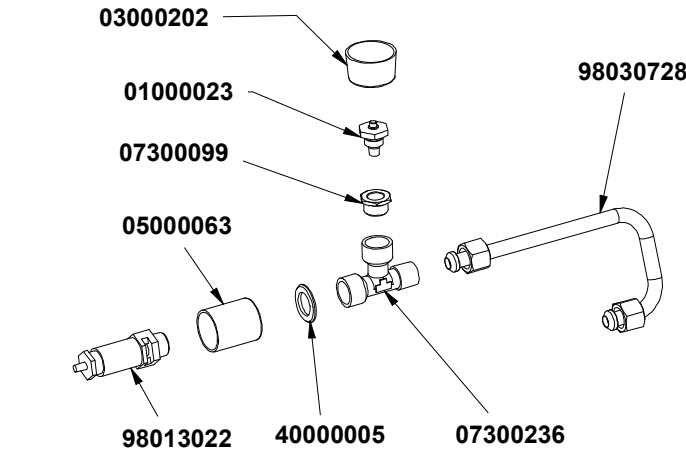

04500033 2GR
04500034 3GR
04500039 3GR**

98170000000011 2GR
98170000000012 3GR
01300005 (100 l/h) 2GR
01300006 (200 l/h) 3GR

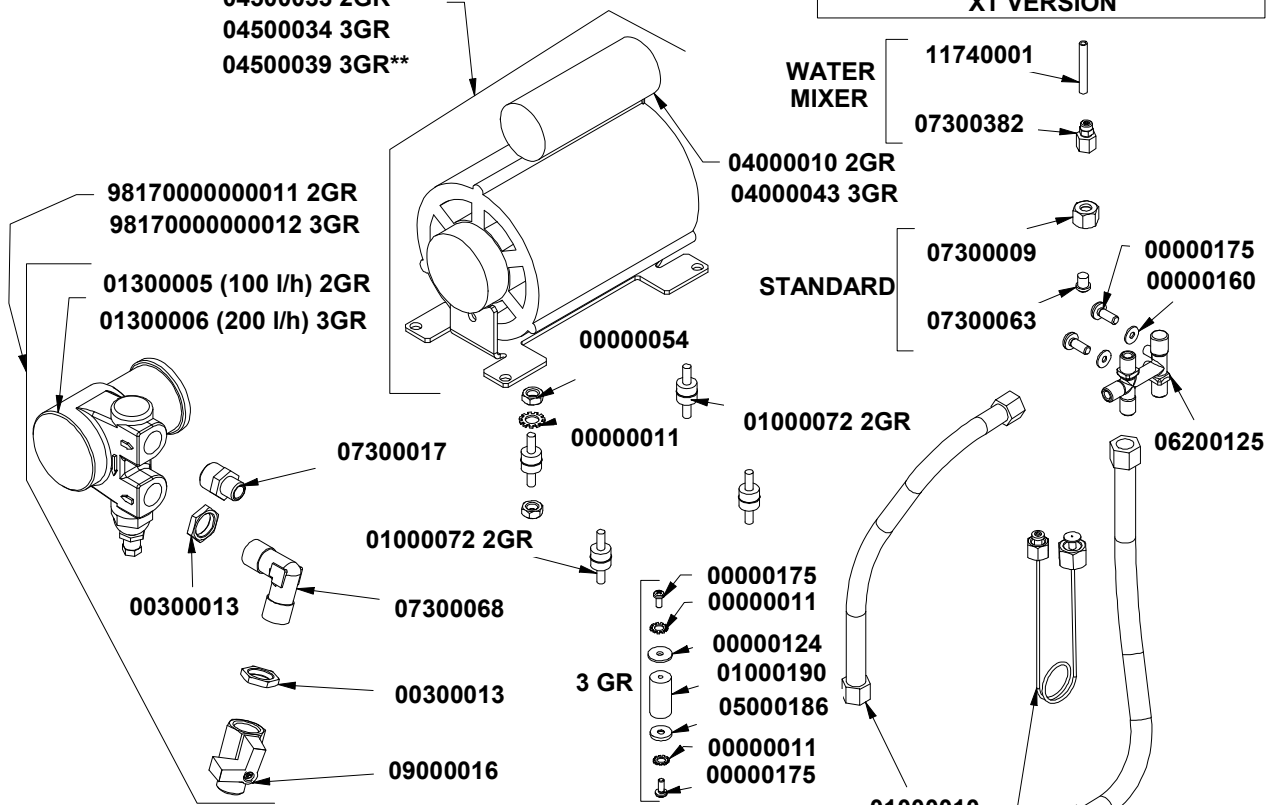

HYDRAULIC COMPONENTS		
CODE	DESCRIPTION	DESCRIZIONE
01000113	Filling pipe L=1500 mm	Tubo ingresso L=1500 mm
01000030	Filling pipe L=500 mm	Tubo ingresso L=500 mm
01000127	Draining pipe	Tubo scarico
00000133	Stainless steel girdle	Fascetta
04000247	Cable digit. press. switch	Cavo press. digitale

**North America Market
Mercato Nord America

COD.	DESCRIPTION	DESCRIZIONE	VAL.
00000011	S/S KNURLED WASHER M4 UNI8842/A	RONDELLA INOX M4 ZIGRINATA UNI8842/A	
00000054	GALV HIGH NUT M4	DADO AQ M4 ALTO ZINCATO	
00000063	GALV WASHER AQ D10X21X2	RONDELLA AQ D 10X21X2 ZN	
00000124	GALV WASHER D4 3x16x1.5	RONDELLA AQ D4.3X16X1.5 ZINC.	
00000133	S/S CLIP WD12 16-25 C7 W2	FASCETTA INOX WD12 16-25 C7 W2	
00000160	S/S WASHER D4X12 UNI 6593	RONDELLA INOX D4X12X1 UNI 6593	
00000175	S/S CROSS HEAD CAP SCREW M4X10	VITE INOX M4X10 TC TCR	
00300005	BRASS NUT 1/8 GAS D4 ADD 22.07.96 CH13	DADO OT 1/8 GAS AGG.22.07.96 SPESS.4 CH13	
00300013	BRASS NUT 3/8 GAS D4 CH20 ADD 22.07.96	DADO OT 3/8 GAS SPESS.4 CH20 AGG.22.07.96	
01000010	S/S FLEXIBLE TUBE 1/4 FF L=320	TUBO FLESS.INOX 1/4-F.F. L=320*KBB*	
R01000010	KIT-S/S FLEXIBLE TUBE 1/4 FF L=320 - 1Pcs	KIT-TUBO FLESS.INOX 1/4-F.F. L=320 - 1Pz	
01000023	ANTI VACUUM VALVE	VALVOLINA SFIATO	
R01000023	KIT-ANTI VACUUM VALVE - 3Pcs	KIT-VALVOLINA SFIATO - 3Pz	
01000030	S/S FLEXIBLE TUBE 3/8 FF L=500	TUBO FLESS INOX 3/8 FF L=500 *KBB*	
01000072	ANTI-VIBRATING AD 10X10 M4 MM	ANTIVIBRANTE AD 10X10 M4 MM * KB *	
01000113	S/S FLEXIBLE TUBE 3/8 90° 3/8 FF L1500	TUBO FLESS INOX 3/8 A 90 F. - 3/8 F. L=1500 *KBB*	
01000127	DIRECT SLEEVE DISCHARGE TUBE D19 L=2m	TUBO SCARICO CON MANICOTTO DIRITTO D.19 L= 2 M	
R01000127	KIT-DIRECT SLEEVE DISCHARGE TUBE D19 L=2m - 2Pcs	KIT-TUBO SCARICO CON MANICOTTO DIRITTO D.19 L= 2 m	
01000190	VIBRATION DAMPER D15x30 M4 FF	ANTIVIBRANTE CD15X30 M4 FF * KB *	
01300005	VOLUMETRIC PUMP 100 Lt/h OT-57	POMPANTE VOLUMETRICO 100 LT/H OT-57 *KBB*	
01300006	VOLUMETRIC PUMP 200 Lt/h OT-57	POMPANTE VOLUMETRICO 200 LT/H OT-57 *KBB*	
03000202	CONDENSATION TRAY MASTER	VASCHETTA RACCOGLI CONDENSA AGG. 07.06.97	
R03000202	KIT-CONDENSATION TRAY - 2Pcs	KIT-VASCHETTA RACCOGLI CONDENSA - 2Pz	
04000010	CAPACITOR 6 MICRO F	CONDENS. 6MICROF X 04500033 UL	
04000043	CAPACITOR 10mF x 04500034	CONDENS.10MICROF X 04500034 UL	
R04000043	KIT-CAPACITOR 10mF - 1Pcs	KIT-CONDENSATORE 10microF - 1Pz	
04000247	CONN. CABLE 3P RAST 2,5/MOLEX L.800MM	CAVO COLL.3P RAST 2,5/MOLEX L.800MM	
04500033	ELEC ENGINE MASTER/PREMIER 2001 230V 50/60Hz 120W	MOTORE EL. MASTER/PREMIER 2001230V 50/60HZ 120W *	
04500034	ELEC ENGINE 230V 50/60Hz 165W	MOTORE ELETTRICO 230V 50/60HZ165W *KBB*	
04500039	ELEC ENGINE 220/240V 50/60Hz 165W FOR CSA	MOTORE ELETTRICO 220/240V 50/60HZ 165W (X MACCHIN	
05000063	SAFETY VALVE COVER PA6	COPRI VALVOLA SICUREZZA PA6	
R05000063	KIT-SAFETY VALVE COVER PA6 - 8Pcs	KIT-COPRI VALVOLA SICUREZZA PA6 - 8Pz	
05000186	H3 D6,3/20 NYLON INSERT OSCAR GROUP BLACK	INSERTO NYLON GR. OSCAR H3 D.6,3/20 NERO	
06200125	4WAY MANIFOLD 1/4M OT-57 USA	CROCIERA 4 VIE 1/4M OT-57 USA	
07300009	NUT FITTING 1/4 GAS	DADO RACCORDO 1/4 GAS	
07300017	FITTING 1/4M 3/8M GAS OT-57 USA	RACCORDO 1/4M 3/8M GAS OT-57 USA	
07300063	CLOSED TERMINAL D11	TERMINALE CHIUSO D.11	
07300068	FITTING L 3/8 M-M CYLIN	RACCORDO L 3/8 M-M CILIN.	
07300099	FITTING ADAPTER 3/8-1/4 ES. 20 ADD. 29.05.96	RIDUZIONE 3/8-1/4 ES.20 AGG. 29.05.96	
07300236	T FITTING 3/8 M-F-F 466	RACCORDO A T 3/8 M-F-F	
R07300236	KIT-T FITTING 3/8 M-F-F - 3Pcs	KIT-RACCORDO A T 3/8 M-F-F - 3Pz	
07300249	FITTING 1/8M L = 12 3/8F	RACCORDO 1/8M L=12 3/8F	
07300382	STRAIGHT FITTING 1/4 F	RACCORDO DIR. 1/4 F - CALZAM.	
09000016	SPHERE TAP - NETWORK CONNECTION 3/8 M-F MINI	RUBINET. SFERA ALLACCIO RETE 3/8 M-F MINI	
R09000016	KIT-SPHERE TAP - NETWORK CONNECTION 3/8 M-F MINI	KIT-RUBINET. SFERA ALLACCIO RETE 3/8 M-F MINI- 2Pz	

COD.	DESCRIPTION	DESCRIZIONE	VAL.
09100003	DOUBLE SCALE GAUGE 2,5:15 D.60	MANOMETRO DOPPIA SCALA 2,5:15 D.60	
R09100003	KIT-DOUBLE SCALE GAUGE 2,5:15 D.60 - 1Pcs	KIT-MANOMETRO DOPPIA SCALA 2,5:15 D.60 - 1Pz	
09100009	GAUGE SCALE 0-16 BAR 1/8 D.60 NUOVA SIMONELLI	MANOMETRO SCALA 0-16 BAR 1/8 D.60 NUOVA SIMONELLI	
09200018	PRESSURE TRANSDUCER R1	TRASD. DI PRES. R1 5V DCM3/8" GAS - OUT 0,5/4,5V	
R09200018	KIT-PRESSURE TRANSDUCER R1 (W/O WIRE 04000244)	KIT-TRASDUTTORE DI PRESSIONE (SENZA CAVETTO)- 1Pz	
11740001	TEFLON PIPE 6/4	TUBO TEFLON 6/4	
40000005	BRASS WASHER 27x17x2 ROUGH	RONDELLA OT 27X17X2 GREZZA	
98013022	SAFETY VLVE C10 1,8 BAR 3/8" VITON 97/23/CE	VALVOLA SICUREZZA C10 1,8 BAR 3/8" VITON 97/23/CE CA	
R98013022	KIT-SAFETY VLVE C10 1,8 BAR 3/8" VITON 97/23/CE - 1Pcs	KIT-VALVOLA SICUREZZA C10 1,8 BAR 3/8" VITON- 1Pz	
98030075	CAPILLARY TUBE 1/8-1/4 0,9X2X400 GAUGE-PUMP	TUBO CAPILLARE 1/8-1/4 0,9X2X400 MANOM.-POMPA	
R98030075	KIT-CAPILLARY TUBE 1/8-1/4 0,9X2X400 GAUGE-PUMP - 2	KIT-TUBO CAPILLARE 1/8-1/4 0,9x2x400 MANOM.-POMPA- 2	
98030707	PIPE BOILER-PRESSURE SENSOR 2-3GR.	TUBO CALDAIA-SENSORE PRESSIONE 2-3GR.	
98030708	BOILER - PRESSURE GAUGE TUBE APPIA19 2-3GR	TUBO CALDAIA-MANOMETRO APPIA19 2-3GR.	
98030728	SAFETY VALVE PIPE 2-3GR.	TUBO COLL. VALVOLA SICUREZZA 2-3GR.	
98170000000011	PUMP OT 100LT SET + CONNECTORS	ASSIEME POMPANTE OT 100LT + RACCORDI	
98170000000012	PUMP OT 200LT SET + CONNECTORS	ASSIEME POMPANTE OT 200LT + RACCORDI	

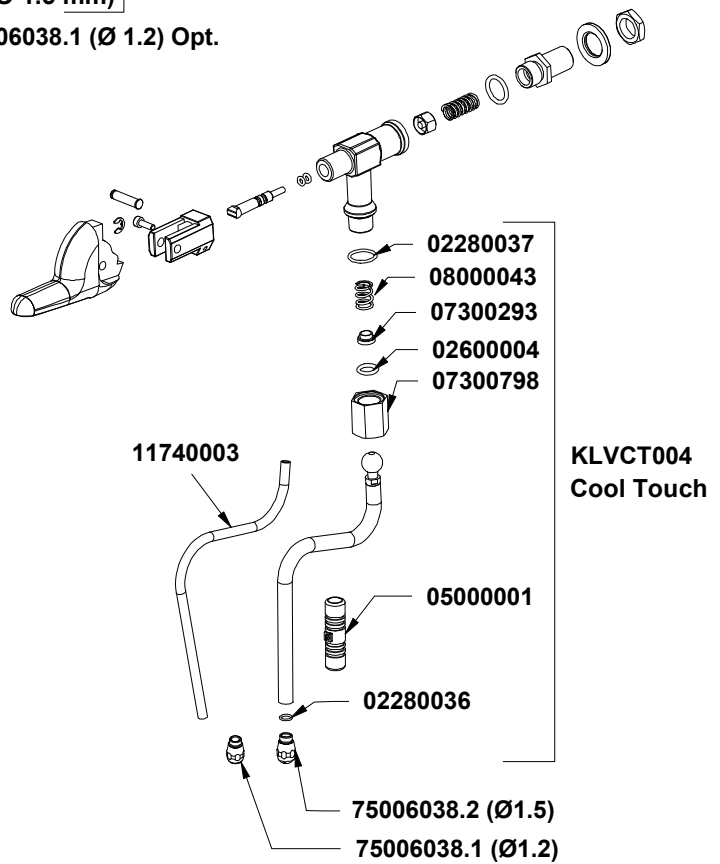
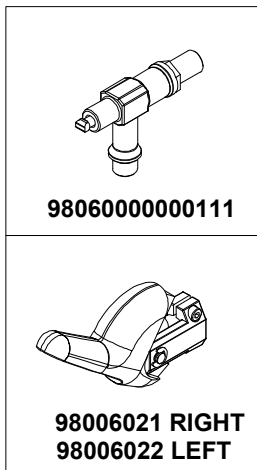
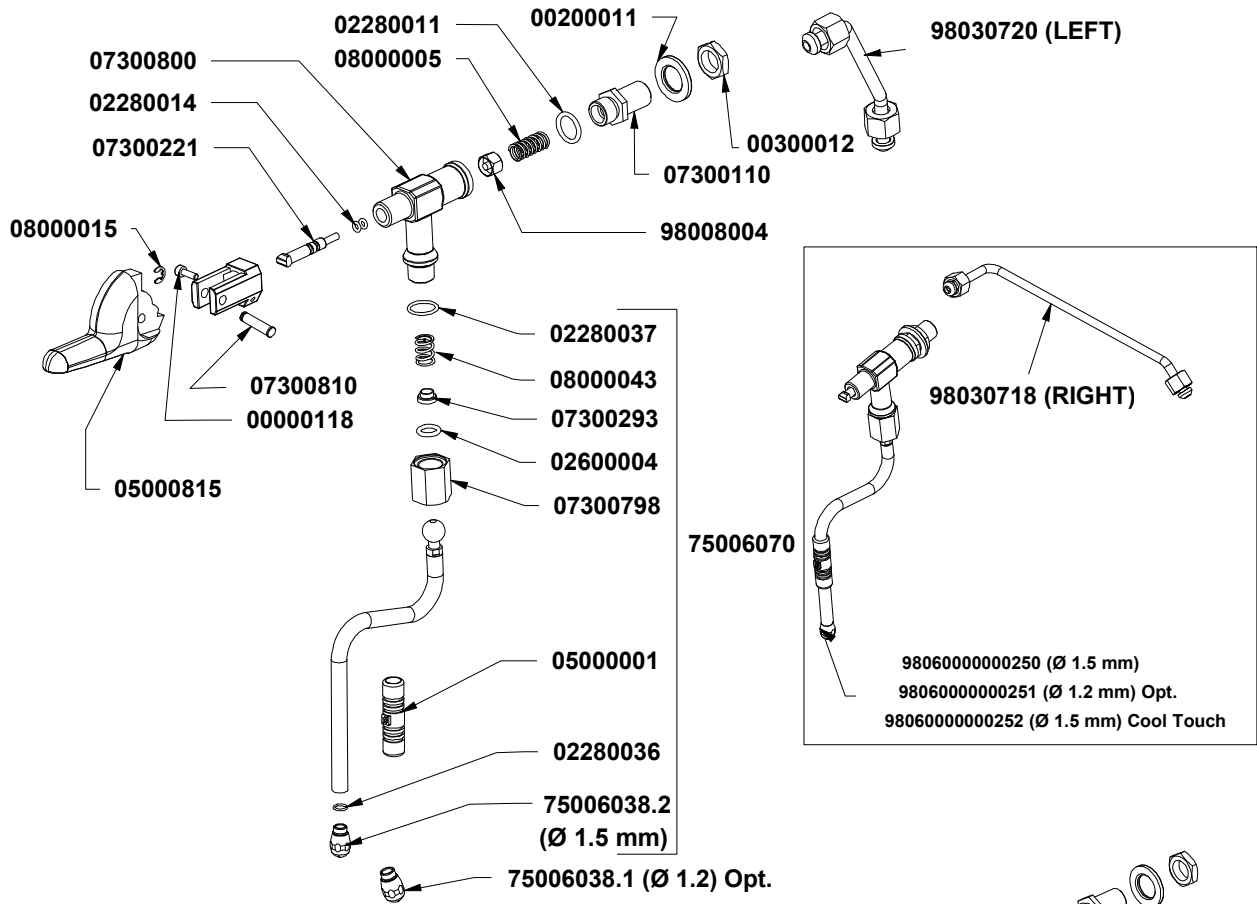

COD.	DESCRIPTION	DESCRIZIONE	VAL.
00000118	S/SHEX SOCKET CAP SCREW M4x12 5931	VITE INOX M4X12 TCEI 5931	
00200011	GALV WASHER M16 17x30x3	RONDELLA AQ M16 17X30X3 ZINC	
00300012	BRASS NUT 3/8 GAS D6 CH22 ADD 22.07.96	DADO OT 3/8 GAS CH22 SPESS.6 AGG. 22.07.96	
02280011	GASKET O RING R11 D19 EP 851	GUARN. OR R11 D19 EP 851	
R02280011	KIT-GASKET O RING R11 D19 EP - 25Pcs	KIT-GUARN. OR R11 D19 EP - 25Pz	
02280014	GASKET GASKET O RING D.7 AN2/OR102 SILICON	GUARN. OR D7 AN2/OR102 SILICON7XL1715	
R02280014	KIT-GASKET GASKET O RING D.7 AN2/OR102 SILICON - 3	KIT-GUARN. OR D7 SILICON 7XL1715 - 30Pz	
02280036	O RING STEAM WAND NOZZ. D6x1.2 EPDM70	GUARN. OR BECCO LANCIA VAP. DI 6X1.2 EPDM70	
R02280036	KIT-O RING FOR STEAM WAND NOZZLE D6x1.2 EPDM - 6	KIT-GUARN. OR x BECCO LANCIA VAP. D. 6x1.2 EPDM- 65P	
02280037	GASKET O RING JOINT LOCK 16x2 NBR70	GUARN. OR CHIUSURA SNODO 16X2 NBR70	
R02280037	KIT-GASKET O RING JOINT LOCK 16x2 NBR - 45Pcs	KIT-GUARN. OR CHIUSURA SNODO 16x2 NBR - 45Pz	
02600004	O RING 15,2x10,2x2,5 TEFLON x STEAM WAND SPHERE	GUARN. OR 15,2X10,2X2,5 TEFLONX SFERA LANCIA VAPO	
R02600004	KIT-O RING 15,2x10,2x2,5 TEFLON x STEAM - 55Pcs	KIT-GUARN. OR 15,2x10,2x2,5 TEFLONx SFERA LANCIA- 55	
05000001	RUBBER PROTECTION FOR STEAMWAND D10	GOMMINO PROTEZIONE LANCIA D.10	
R05000001	KIT-RUBBER PROTECTION FOR STEAMWAND D10 - 10Pc	KIT-GOMMINO PROTEZIONE LANCIA D.10 - 10Pz	
05000815	STEAM LEVER HANDLE AURELIA 2011	MANOPOLA VAPORE "AURELIA" 2011	
R05000815	KIT-STEAM LEVER HANDLE - 2Pcs	KIT-MANOPOLA VAPORE - 2Pz	
07300110	SPRING HOLDER TAP R.V. PR. OT-58	TAPPO PORTA MOLLA R.V. PR. OT-58	
R07300110	KIT-SPRING HOLDER TAP R.V. PR. - 6Pcs	KIT-TAPPO PORTA MOLLA R.V. PR. - 6Pz	
07300221	S/S STEAMTAP ROD	ASTA INOX RUBINETTO VAPORE	
R07300221	KIT-S/S STEAMTAP ROD - 3Pcs	KIT-ASTA INOX RUBINETTO VAPORE - 3Pz	
07300293	ARTICULATED BUSHING AG.25.06.96 OT-57	BUSSOLA SNODO AG.25.06.96 OT-57	
R07300293	KIT-ARTICULATED BUSHING - 15Pcs	KIT-BUSSOLA SNODO - 15Pz	
07300798	NUT FITTING 3/8 H=26 BRASS-NICKEL ARTICULATED WAI	DADO RACC. 3/8 H=26 LANCIA SNODATA OTTONE NICHEL	
R07300798	KIT-NUT FITTING 3/8 H=26 BRASS-NICKEL ARTICULATED	KIT-DADO RACC. 3/8 H=26 LANCIA SNODATA OTTONE- 4Pz	
07300800	STEAM TAP BODY AURELIA II OT-57	CORPO RUB.VAPORE AURELIA II OT-57	
R07300800	KIT-STEAM TAP BODY - 1Pcs	KIT-CORPO RUB.VAPORE - 1Pz	
07300810	STEAM TAP PIN AURELIA IIOT-58	SPINOTTO RUB.VAPORE AURELIA IIOT-58	
R07300810	KIT-STEAM TAP PIN - 25Pcs	KIT-SPINOTTO RUB.VAPORE - 25Pz	
08000005	STEAM TAP SPRING 6 ST 11,5X8,5X25	MOLLA 6 ST 11,5X8,5X25 RUB.VAPORE	
R08000005	KIT-STEAM TAP SPRING 6 ST 11,5X8,5X25 - 15Pcs	KIT-MOLLA 6 ST 11,5X8,5X25 RUB.VAPORE - 15Pz	
08000015	S/S SEEGER RING TYPE RS 5 UNI7434	ANELLO SEEGER TIPO RS 5 INOX UNI7434	
08000043	SPRING FOR ARTICULATED WAND D.1.6 D.11.9x16.2	MOLLA PER LANCIA SNODATA FILO D.1.6 D.11.9X16.2 4 SP	
R08000043	KIT-SPRING FOR ARTICULATED WAND D.1.6 D.11.9x16.2	KIT-MOLLA PER LANCIA SNODATA FILO D.1.6 D.11.9x16. - 1	
11740003	CALIBRATED TEFLON PIPE 6/4	TUBO TEFLON 6/4 CALIBRATO	
75006038.1	STEAM NOOZLE M8,65X0,75 F1,2 ESAG.1,2	BECCO VAPORE M8,65X0,75 F. 1,2 ESAG.12	
R75006038.1	KIT-STEAM NOOZLE M8,65X0,75 F1,2 - 1Pcs	BECCO VAPORE M8,65X0,75 F. 1,2 - 1Pz	
75006038.2	STEAM NOZZLE M8,65x0,75 F. 1,5 ESAG.12	BECCO VAPORE M8,65X0,75 F. 1,5 ESAG.12	
R75006038.2	KIT-STEAM NOZZLE M8,65x0,75 F. 1,5 - 1Pcs	KIT-BECCO VAPORE M8,65x0,75 F. 1,5 - 1Pz	
75006070	SS STEAMWAND KIT NOZZLE 1,5mm HIGH NUT APPIA II	KIT LANCIA VAPORE SNODATA INOX CON BECCO 1,5 E DA	
98006021	LEFT STEAM KNOB SET 2004	ASSIEME MANOPOLA VAPORE 2004 DX *KBB*	
R98006021	KIT-RIGHT STEAM KNOB SET - 1Pcs	KIT-ASSIEME MANOPOLA VAPORE DX - 1Pz	
98006022	RIGHT STEAM KNOB SET 2004	ASSIEME MANOPOLA VAPORE 2004 SX *KBB*	
R98006022	KIT-RIGHT STEAM KNOB SET - 1Pcs	KIT-ASSIEME MANOPOLA VAPORE SX - 1Pz	
98008004	COMPLETE STEAM VALVE PISTON	PISTONCINO CHIUSURA COMPLETO	

APPIA
Life.

2-3 GR + XT

2-3 GR + XT

PARTI RUBINETTI VAPORE

STEAM TAPS PARTS

COD.	DESCRIPTION	DESCRIZIONE	VAL.
R98008004	KIT-COMplete STEAM VALVE PISTON - 5Pcs	KIT-PISTONCINO CHIUSURA COMPLETO - 5Pz	
98030718	PIPE STEAM WAND RIGHT	TUBO LANCIA VAP. DX 2-3GR.	
98030720	PIPE STEAM WAND LEFT	TUBO LANCIA VAP. SX APPIA19 2-3GR.	
98060000000111	STEAM TAP SET W/O WAND AURELIA II-APPIA II	ASS. RUBINETTO VAPORE SENZA LANCIA AURELIA II - APF	
98060000000250	STEAM TAP + STEAMWAND SET W/ HIGH NUT APPIA II	ASS. RUBINETTO VAPORE + LANCIA VAPORE CON DADO /	
98060000000251	STEAMTAP + STEAMWAND SET W/HIGH NUT APPIAII 1,2N	ASS. RUBINETTO VAPORE + LANCIA VAPORE CON DADO /	
98060000000252	STEAMTAP + COOL STEAM WAND LIT W/HIGH NUT	ASS. RUBINETTO VAPORE + LANCIA VAPORE FREDDA CO	
KLVCT004	KIT COOLTOUCH STEAM WAND HIGH NUT APPIA II	KIT LANCIA VAPORE "COOL TOUCH" DADO ALTO APPIA II	

APPIA
Life.

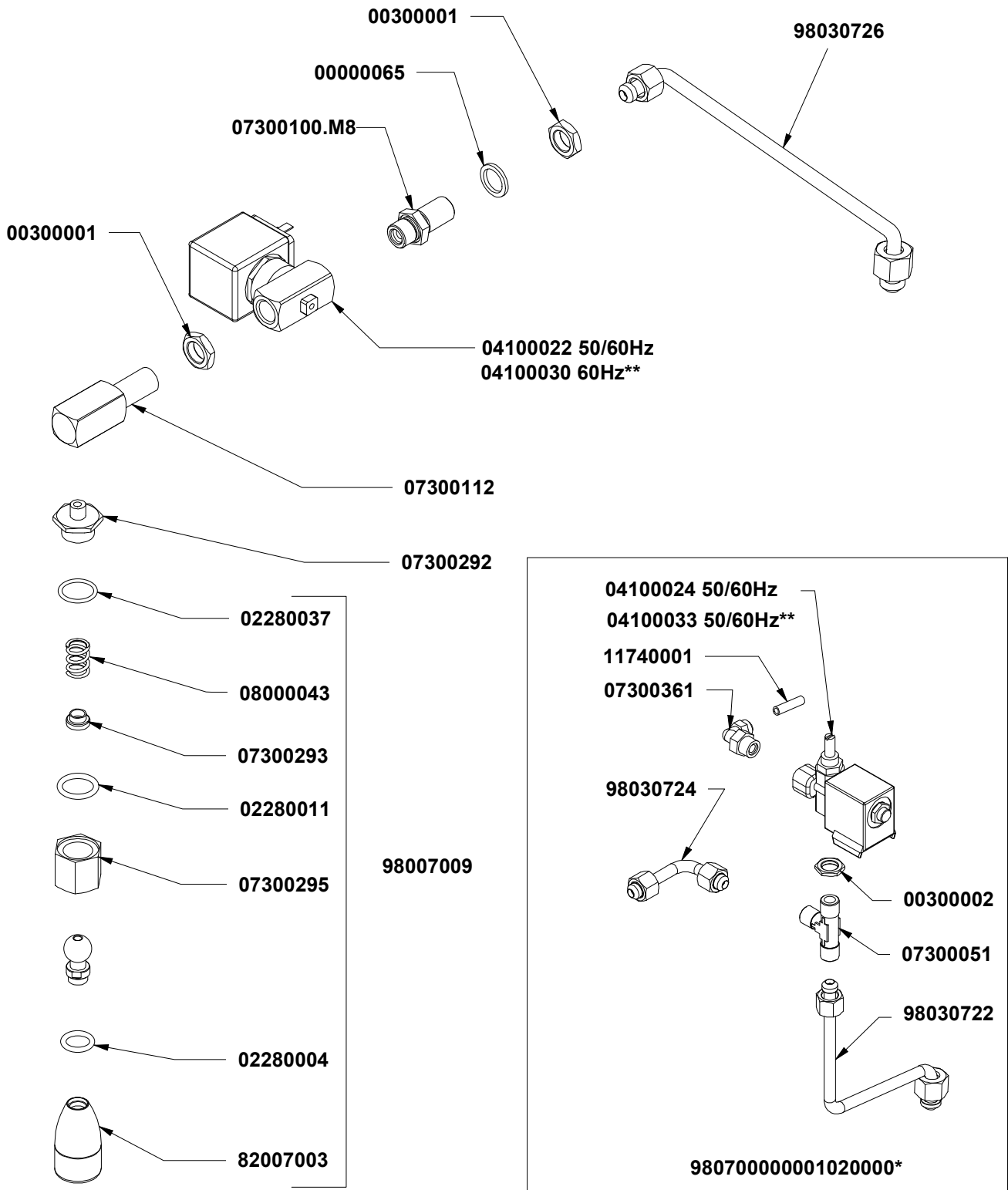

CODE	DESCRIPTION	DESCRIZIONE
04001526	SUPPL. WIR. SOL.VALVE-MI	SUPPL. CABL. E.V. MISC.

*Specificare versione
Specify version

**Mercato Nord America
North America Market

COD.	DESCRIPTION	DESCRIZIONE	VAL.
00000065	BRASS WASHER 1/4	RONDELLA OT 1/4 AGG.07.03.86	
00300001	BRASS NUT 1/4 GAS D5 CH18	DADO OT 1/4 GAS SPESS.5 CH18 *AGG. 22.07.96	
00300002	BRASS NUT 1/4 D3 CH18	DADO OT 1/4 SPESS.3 CH18 AGG. 22.07.96	
R00300002	KIT-BRASS NUT 1/4 D3 - 15Pcs	KIT-DADO OT 1/4 SPESS.3 - 15Pz	
02280004	GASKET O RING 115 D17 EP 856 x SWIVEL STEAM PIPE	GUARN. OR 115 D.17 EP856 SNODO LANCIA	
R02280004	KIT-GASKET O RING 115 D17 EP 856 x STEAM PIPE - 55Pcs	KIT-GUARN. OR 115 D.17 EP856 SNODO LANCIA - 55Pz	
02280011	GASKET O RING R11 D19 EP 851	GUARN. OR R11 D19 EP 851	
R02280011	KIT-GASKET O RING R11 D19 EP - 25Pcs	KIT-GUARN. OR R11 D19 EP - 25Pz	
02280037	GASKET O RING JOINT LOCK 16x2 NBR70	GUARN. OR CHIUSURA SNODO 16X2 NBR70	
R02280037	KIT-GASKET O RING JOINT LOCK 16x2 NBR - 45Pcs	KIT-GUARN. OR CHIUSURA SNODO 16x2 NBR - 45Pz	
04001526	WIRING SOL. VALVE MIXER HOT WATER SEM 2-3GR.	SUPPL. CABLAGGIO E.V. MISCELATORE A.CALDA APPIA SI	
04100022	3WAY SOLENOID 1/4-1/4 220-230V50/60Hz F3 CE TH1xM4	E.V. NC 2VIE 1/4-1/4 220-230V 50/60HZ RUBINO F3 CE PIEC	
R04100022	KIT-3WAY SOLENOID 1/4-1/4 220-230V50/60Hz F3 CE - 1P	KIT-E.V. NC 2VIE 1/4-1/4 220-230V 50/60Hz RUBINO- 1Pz	
04100024	3WAY SOLENOID 1/4 REGUL 90° 230V50/60Hz F3 CE	E.V. NC 2VIE 1/4 REGOLAT. 90° 230V 50/60HZ F.3 CE	
R04100024	KIT-3WAY SOLENOID 1/4 REGUL 90° 230V50/60Hz F3 CE -	KIT-E.V. NC 2VIE 1/4 REGOLAT. 90° 230V 50/60HZ F.3- 1Pz	
04100030	2WAY SOLENOID 1/4-1/4 208-240V 60Hz F3 UL TH1xM4	E.V. NC 2VIE 1/4-1/4 208-240V 60HZ RUBY F3 UL PIEDINO F	
04100033	2WAY SOLENOID 1/4 REGUL 90° 230/240V 50/60Hz	E.V. NC 2VIE 1/4 REGOLAT. 90° 230/240V 50/60HZ F3 UL CA	
07300051	FITTING T 1/4 M-M-M CYLIN.	RACCORDO T 1/4 M-M-M CILIN.	
07300100.M8	DISCHARGE ATTACHMENT 1/4 1/4 + INT M8 OT-57 USA	ATTACCO SCAR. 1/4-1/4 + INT M8OT-57 USA	
R07300100.M8	KIT-DISCHARGE ATTACHMENT 1/4 1/4 + INT - 8Pcs	KIT-ATTACCO SCAR. 1/4-1/4 + INT M8 - 8Pz	
07300112	WATER TAP CONNECTION OT-57 USA	ATTACCO RUB. ACQUA OT-57 USA	
07300292	TAP ATTACHMENT FOR ARTICULATED S/S STEAMWAND	ATTACCO RUBINETTO PER LANCIA VAPORE SNODATA INI	
07300293	ARTICULATED BUSHING AG.25.06.96 OT-57	BUSSOLA SNODO AG.25.06.96 OT-57	
R07300293	KIT-ARTICULATED BUSHING - 15Pcs	KIT-BUSSOLA SNODO - 15Pz	
07300295	NUT FITTING 3/8 H=21 BRASS-NICKEL ART.WAND	DADO RACC. 3/8 H=21 LANCIA SNODATA	
R07300295	KIT-NUT FITTING 3/8 H=21 BRASS-NICKEL ARTICULATED	KIT-DADO RACC. 3/8 H=21 LANCIA SNODATA - 6Pz	
07300361	FITTING L GIR 1/4 M-FITTING 6 VITON 346 A	RACCORDO L GIR 1/4 M-CALZAM.6 VITON 346 A NICHELAT	
R07300361	KIT-FITTING L GIR 1/4 M-FITTING 6 VITON - 4Pcs	KIT-RACCORDO L GIR 1/4 M-CALZAM.6 VITON - 4Pz	
08000043	SPRING FOR ARTICULATED WAND D.1.6 D.11.9x16.2	MOLLA PER LANCIA SNODATA FILO D.1.6 D.11.9X16.2 4 SP	
R08000043	KIT-SPRING FOR ARTICULATED WAND D.1.6 D.11.9x16.2	KIT-MOLLA PER LANCIA SNODATA FILO D.1.6 D.11.9x16.- 1	
11740001	TEFLON PIPE 6/4	TUBO TEFLON 6/4	
82007003	HOTWATER DIFFUSER D23,5 F1/8	ROMPIGETTO ACQUA CALDA D.23,5 F 1/8"	
98007009	S/S HOTWATER WAND KIT L70 W/ DIFFUSER	KIT LANCIA ACQUA C. INOX L=70 COMP. DI ROMPIGETTO &	
R98007009	KIT-S/S HOTWATER WAND KIT L70 W/ DIFFUSER - 1Pcs	KIT-KIT LANCIA ACQUA C. INOX L=70 COMP. DI ROMPIGE-	
98030722	BOILER-WATER MIXER PIPE 2-3GROUPS	TUBO CALDAIA - EV MISCELATORE APPIA19 2-3GR.	
98030724	PIPE MIXER-HOT WATER WAND 2-3GROUPS	TUBO EV MISCELAT.-LANCIA ACQUA CALDA 2-3GR.	
98030726	BOILER-HOT WATER SOL. VALVE 2-3GROUPS	TUBO CALDAIA - EV ACQUA CALDA 2-3GR.	
98070000001020001	MIXER ASSEMBLY HOT WATER 2-3 GR. CE	ASS. MISCELATORE A.CALDA 2-3GR. CE	
98070000001020002	MIXER ASSEMBLY HOT WATER 2-3 GR. KETI-KC	ASS. MISCELATORE A.CALDA 2-3GR. KETI - KC	
98070000001020003	MIXER ASSEMBLY HOT WATER 2-3 GR. CSA	ASS. MISCELATORE A.CALDA 2-3GR. CSA	

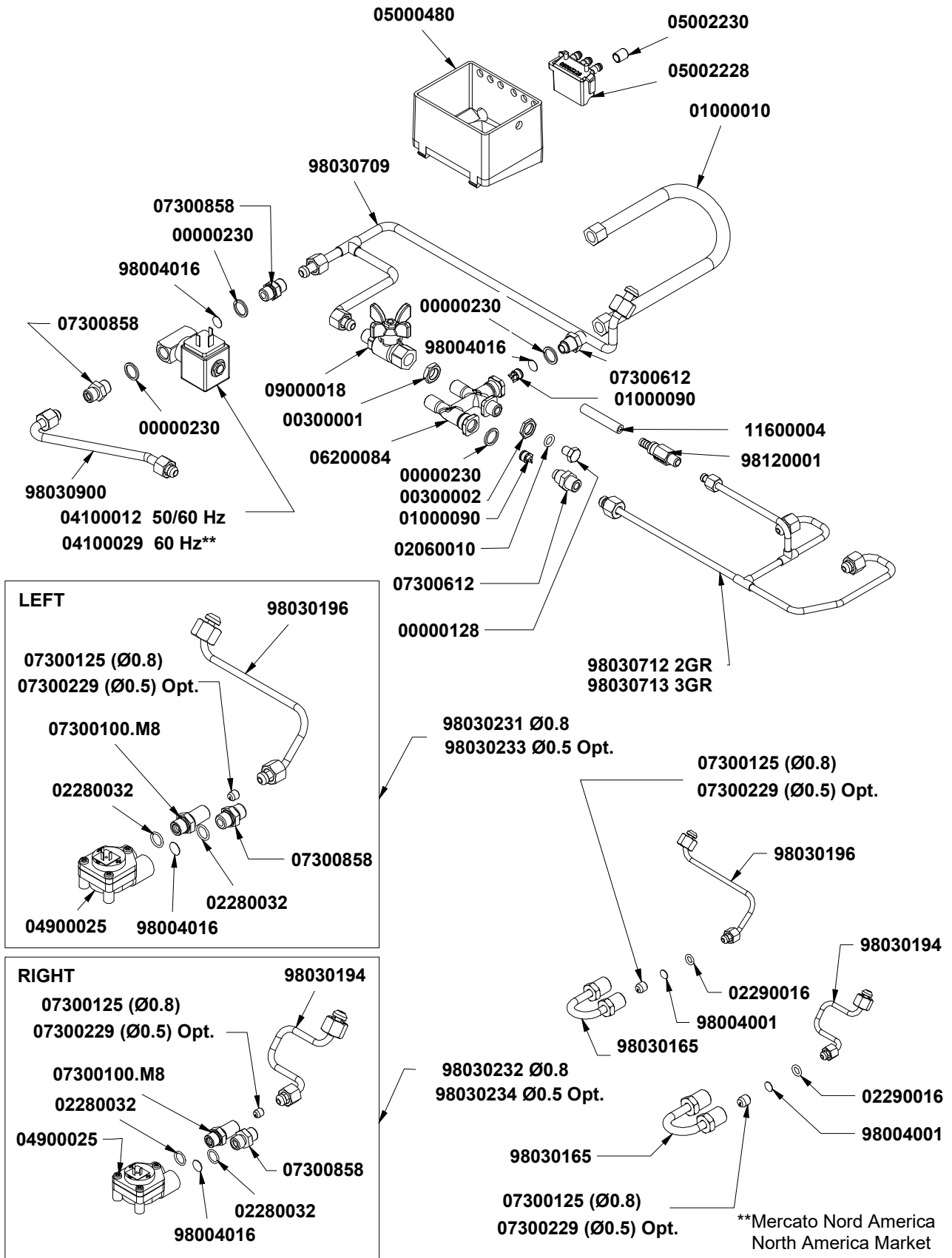

COD.	DESCRIPTION	DESCRIZIONE	VAL.
00000128	S/S HEX CAP SCREW M8x10 THREADED	VITE INOX M8X10 TE TUTTO FIL.	
00000230	COPPER WASHER SEAL 14X18X1.5	RONDELLA GUARNIZIONE RAME RICOTTO 14X18X1.5	
00300001	BRASS NUT 1/4 GAS D5 CH18	DADO OT 1/4 GAS SPESS.5 CH18 *AGG. 22.07.96	
00300002	BRASS NUT 1/4 D3 CH18	DADO OT 1/4 SPESS.3 CH18 AGG. 22.07.96	
R00300002	KIT-BRASS NUT 1/4 D3 - 15Pcs	KIT-DADO OT 1/4 SPESS.3 - 15Pz	
01000010	S/S FLEXIBLE TUBE 1/4 FF L=320	TUBO FLESS.INOX 1/4-F.F. L=320*KBB*	
R01000010	KIT-S/S FLEXIBLE TUBE 1/4 FF L=320 - 1Pcs	KIT-TUBO FLESS.INOX 1/4-F.F. L=320 - 1Pz	
01000090	RETAINING VALVE D10	VALVOLINA DI RITEGNO D.10	
R01000090	KIT-RETAINING VALVE D10 - 6Pcs	KIT-VALVOLINA DI RITEGNO D.10 - 6Pz	
02060010	COPPER O RING 8.3x13x1.9 ND8	OR RAME 8,3X13XH1,9 DN8	
02280032	GASKET O RING 114 D15 EP 851	GUARN. OR 114 D.15 EP 851	
R02280032	KIT-GASKET O RING 114 D15 EP - 25Pcs	KIT-GUARN. OR 114 D.15 EP - 25Pz	
02290016	GASKET O RING D9,5 R5 SIL RED	GUARN. OR D 9,5 R5 SILICONE R.	
R02290016	KIT-GASKET O RING D9,5 SIL RED - 30Pcs	KIT-GUARN. OR D 9,5 SILICONE R. - 30Pz	
04100012	2WAY SOLENOID 1/8-1/8 1/8 240V50/60hz F3 UL TH2xM5	E.V. NC 2VIE 1/4-1/4 220-230V 50/60HZ VITON F1.5 CE	
R04100012	KIT-2WAY SOLENOID 1/8-1/8 1/8 240V50/60hz F3 - 1Pcs	KIT-E.V. NC 2VIE 1/4-1/4 220-230V 50/60HZ VITON- 1Pz	
04100029	2WAY SOLENOID 1/4-1/4 208-240V 60Hz F1.5 UL TH1xM4	E.V. NC 2VIE 1/4-1/4 208-240V 60HZ VITON F1.5 UL PIEDINC	
04900025	BRASS FLOWMETER 1/4-1/4 GAS-ATT. HEAD 2,8x0,5	DOSATORE VOLUMETRICO OTT. 1/4-1/4 GAS-ATT. TEST. 2	
05000480	DRAIN TRAY VA358	VASCHETTA SCARICO VA358	
05002228	DISCHARGE MANIFOLD DISPENSING GROUP	COLLETTORE SCARICO GRUPPI EROG	
05002230	DRAIN RUBBER PLUG D8 x 05002228	TAPPO GOMMA SCARICO D.8 X 05002228	
06200084	5WAY MANIFOLD AURELIA OT-57 USA	CROCIERA 5 VIE AURELIA OT-57 USA	
R06200084	KIT-5WAY MANIFOLD USA - 1Pcs	KIT-CROCIERA 5 VIE - 1Pz	
07300100.M8	DISCHARGE ATTACHMENT 1/4 1/4 + INT M8 OT-57 USA	ATTACCO SCAR. 1/4-1/4 + INT M8OT-57 USA	
R07300100.M8	KIT-DISCHARGE ATTACHMENT 1/4 1/4 + INT - 8Pcs	KIT-ATTACCO SCAR. 1/4-1/4 + INT M8 - 8Pz	
07300125	GIGLEUR M8x8 F.0,8 OT-57 +TEA	GIGLER M8X8 F.0,8 OT-57 +TEA	
R07300125	KIT-GIGLEUR M8x8 F.0,8 +TEA - 15Pcs	KIT-GIGLER M8x8 F.0,8 - 15Pz	
07300229	GIGLEUR M8X8 F.0,5 OT-57 + TEA	GIGLER M8X8 F.0,5 OT-57 +TEA	
R07300229	KIT-GIGLEUR M8X8 F.0,5 + TEA - 15Pcs	KIT-GIGLER M8x8 F.0,5 - 15Pz	
07300612	FITTING 1/4 1/4 GAS WITH ORING + RET. VALVE LOCK	RACCORDO 1/4 1/4 GAS CON OR	
07300858	FITTING 1/4M-1/4M OT-57 USA	RACCORDO 1/4M-1/4M OT-57 USA	
R07300858	KIT-FITTING 1/4M-1/4M - 15Pcs	KIT-RACCORDO 1/4M-1/4M - 15Pz	
09000018	DISPENSING SPHERE TAP 1/4 M-F "BUTTERFLY"	RUBINET. SFERA DISTRIBUTORE 1/4 M-F A FARFALLA	
11600004	SILICONE PIPE 5x9 60Sh PEROX	TUBO SILICONE 5X9 60SH PEROX BIANCO (1MT=50GR)	
98004001	S/S FILTER D8	FILTRO INOX DIAM. 8	
98004016	S/S FILTER D12	FILTRO INOX DIAM. 12	
R98004016	KIT-S/S FILTER D12 - 25Pcs	KIT-FILTRO INOX DIAM. 12 - 25Pz	
98030165	TUBE 1/4 1/4 SEMI-AUTO MODIFY APPIA 1-2-3GR	TUBO 1/4 1/4 MODIFICA SEMIAUT APPIA 1-2-3 GR.	
98030194	TUBE 3/8 1/4 RIGHT EXCHANGER APPIA S-V 2-3GR	TUBO 3/8 1/4 COLL. SCAMB. DX APPIA S-V 2-3 GR.	
R98030194	KIT-TUBE 3/8 1/4 RIGHT EXCHANGER - 2Pcs	KIT-TUBO 3/8 1/4 COLL. SCAMB. DX - 2Pz	
98030196	TUBE 3/8 1/4 LEFT EXCHANGER APPIA S-V 2-3GR	TUBO 3/8 1/4 COLL. SCAMB. SX APPIA S-V 2-3 GR.	
98030231	LEFT FLOWMETER SET APPIA 2-3GR GIGLER F.0,8	ASSIEME DOSATORE SX APPIA 2-3GR. GIGLER F.0,8	
98030232	RIGHT FLOWMETER SET APPIA 2-3GR GIGLER F.0,8	ASSIEME DOSATORE DX APPIA 2-3GR. GIGLER F.0,8	
98030233	LEFT FLOWMETER SET APPIA 2-3GR GIGLER F.0,5	ASSIEME DOSATORE SX APPIA 2-3GR. GIGLER F.0,5	
98030234	RIGHT FLOWMETER SET APPIA 2-3GR GIGLER F.0,5	ASSIEME DOSATORE DX APPIA 2-3GR. GIGLER F.0,5	

APPIA
Life.

2-3 GR + XT

2-3 GR + XT

COMPONENTI GRUPPO IDRAULICO

HYDRAULIC GROUP PARTS

COD.	DESCRIPTION	DESCRIZIONE	VAL.
98030709	BOILER LOADING CENTRAL PIPE 2-3GR	TUBO CARICO CENTRALE CALDAIA APPIA19 2-3GR.	
98030712	MANIFOLD 2GR APPIA19	CROCIERA 2GR. APPIA19	
98030713	MANIFOLD 3GR APPIA19	CROCIERA 3GR. APPIA19	
98030900	VALVE LEVEL - MANIFOLD TUBE VA358	TUBO E.V. LIVELLO-CROCIERA VA358	
98120001	NEPLAX VITON 16,5 BAR VALVE 1/8 HOSE CLAMP	VALVOLA NEPLAX VITON 16,5 BAR 1/8 - PORTAGOMMA	
R98120001	KIT-NEPLAX VITON 16,5 BAR VALVE 1/8 HOSE CLAMP - 2F	KIT-VALVOLA NEPLAX VITON 16,5 BAR 1/8 - PORTAGOMMA/	

APPIA
Life.

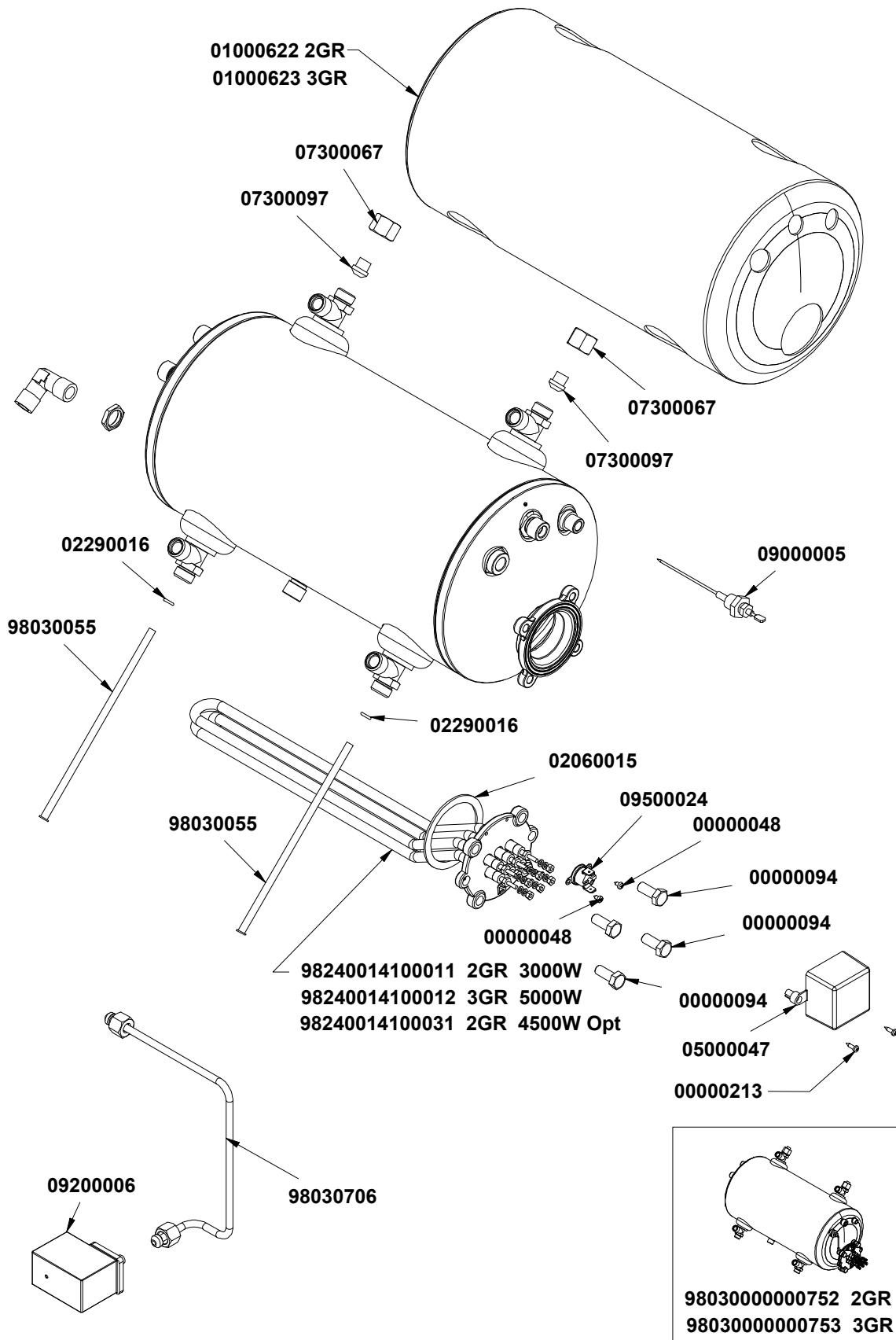

COD.	DESCRIPTION	DESCRIZIONE	VAL.
00000048	SELF-TAPPING SCREW 2.9x4.5 TC/T.CR.	VITE AUTOF 2,9X4,5 TC/T.CR.	
00000094	S/S HEX CAP SCREW M8x20 5739	VITE INOX M8X20 TE 5739	
00000213	GALV SELF-TAPPING SCREW 4,2x16 TC T.CR.	VITE AUTOF 4,2X16 TC T.CR. ZIN	
01000622	BOILER INSULATION 2GR	ISOLANTE CALDAIA 2GR	
01000623	BOILER INSULATION 3GR	ISOLANTE CALDAIA 3GR	
02060015	GASKET FOR HEATING ELEMENT 067x054x2	GUARNIZIONE PTFE 067X054X2	
R02060015	KIT-GASKET FOR HEATING ELEMENT 067x054x2 - 8Pcs	KIT-GUARNIZIONE PTFE 067x054x2 - 8Pz	
02290016	GASKET O RING D9,5 R5 SIL RED	GUARN. OR D 9,5 R5 SILICONE R.	
R02290016	KIT-GASKET O RING D9,5 SIL RED - 30Pcs	KIT-GUARN. OR D 9,5 SILICONE R. - 30Pz	
05000047	SQAURE RESISTANCE COVER V0	COPRI RESISTENZA QUADRATA V0	
R05000047	KIT-SQAURE RESISTANCE COVER V0 - 6Pcs	KIT-COPRI RESISTENZA QUADRATA - 6Pz	
07300067	NUT FITTING 3/8 GAS D11 ADD. 15.11.84 OT-58	DADO RACCORDO 3/8 GAS D11 AGG. 15.11.84 OT-58	
07300097	CLOSED TERMINAL D14 OT-57	TERMINALE CHIUSO D 14 OT-57	
09000005	COMPLETE AUTOLEVEL PROBE L=130	SONDA AUTOLIVELLO COMP. L=130	
R09000005	KIT-COMPLETE AUTOLEVEL PROBE L=130 - 1Pcs	KIT-SONDA AUTOLIVELLO COMP. L=130 - 1Pz	
09200006	MACHINE PRESSO GAUGE CE/UL TRIF. 30A 400V	PRESSOSTATO CE/UL TRIF. 30A 400V 0,5-1,4BAR	
R09200006	KIT-MACHINE PRESSO GAUGE CE/UL TRIF. 30A 400V - 1P	KIT-PRESSOSTATO MACCHINA CE/UL TRIF. 30A 400V- 1Pz	
09500024	MANUAL THERMOSTAT 135°C TRIP FREE GREEN DRIP.	TERMOSTATO R.MAN. 135°C TRIP FREE	
9803000000752	COMPLETE BOILER SET 2GR APPIA19	ASSIEME CALDAIA COMP.2GR APPIA19	
9803000000753	COMPLETE BOILER SET 3GR APPIA19	ASSIEME CALDAIA COMP.3GR APPIA19	
98030055	INTERNAL TEFLON TUBE EXCHANGER D6x180mm	TUBO TEFLON INT. SCAMBIATORE D.6 X 180 MM.	
R98030055	KIT-INTERNAL TEFLON TUBE EXCHANGER D6x180mm - 3	KIT-RESISTENZA CALDAIA OSCAR 1" 1200W 230V +T.P.- 3F	
98030706	PIPE BOILER-PRESSURE SWITCH 2-3GR.	TUBO CALDAIA-PRESSOSTATO APPIA19 2-3GR.	
98240014100011	HEATING ELEMENT W/ NUTS 3000W	RESISTENZA COMPLETA DI DADI 3000W	
98240014100012	HEATING ELEMENT W/ NUTS 5000W	RESISTENZA COMPLETA DI DADI 5000W	
R98240014100012	KIT-HEATING ELEMENT W/ NUTS 5000W - 1Pcs	KIT-RESISTENZA COMPLETA DI DADI 5000W - 1Pz	
98240014100031	HEATING ELEMENT W/ NUTS 4500W	RESISTENZA COMPLETA DI DADI 4500W	
R98240014100031	KIT-HEATING ELEMENT W/ NUTS 4500W - 1Pcs	KIT-RESISTENZA COMPLETA DI DADI 4500W - 1Pz	

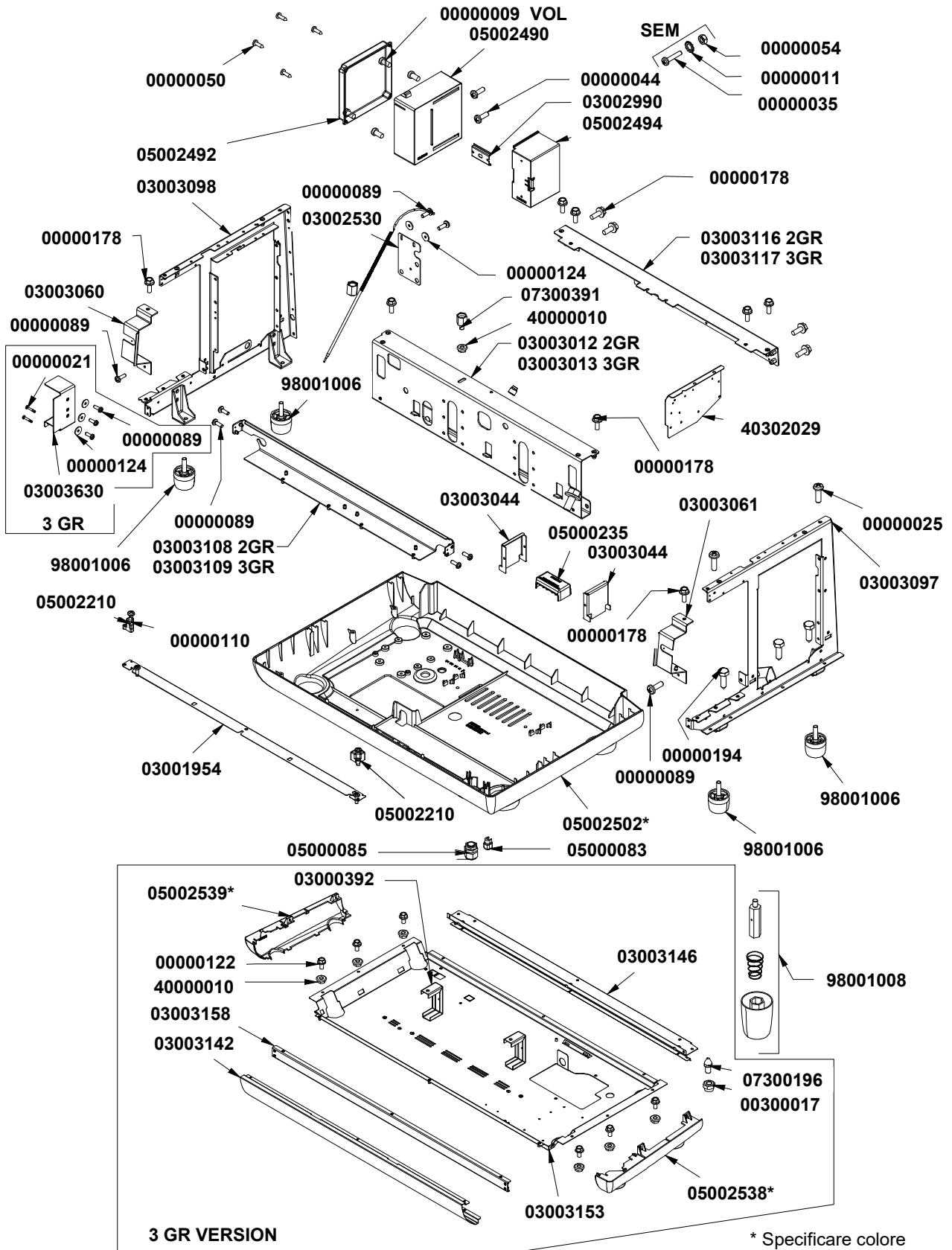

* Specificare colore
Specify color

COD.	DESCRIPTION	DESCRIZIONE	VAL.
00000009	GALV SELF-TAPPING SCREW 3,5x6,5 MUSTAD	VITE AUTOF 3,5X8 Z.B. HILO TC TCR	
00000011	S/S KNURLED WASHER M4 UNI8842/A	RONDELLA INOX M4 ZIGRINATA UNI8842/A	
00000021	GALV CROSS HEAD CAP SCREW M4x25	VITE AQ M4X25 TC T.CR. ZINC. TAPT AUTOFORMANTE	
00000025	GALV CROSS HEAD CAP SCREW AQ M6x20	VITE AQ M6X20 TC T.CR. ZINC	
00000035	GALV CROSS HEAD/CAP SCREW M4X20	VITE AQ M4X20 TC T.CR. ZINC	
00000044	GALV CROSS HEAD/CAP SCREW M4x10	VITE AQ M4X10 TC T.CR. ZINC	
00000050	CROSS HEAD/CAP SELF-TAPPING SCREW 3,5x12	VITE AUTOF 3,5X12 TC/T.CR. TRUCIOLARE	
00000054	GALV HIGH NUT M4	DADO AQ M4 ALTO ZINCATO	
00000089	S/S CROSSHEAD CAP SCREW M4x12 DIN7985	VITE INOX M4X12 TC TCR DIN7985	
00000110	S/S CROSS HEAD CAP SCREW M4x20 7985	VITE INOX M4X20 TC T.CR. 7985	
00000122	WHITE GALV FLANGED KNURLED HEX CAP SCREW 8.8 M	VITE AQ 8.8 M6X12 TE FLANG. ZIGR. ZINC. BIANCO	
00000124	GALV WASHER D4 3x16x1.5	RONDELLA AQ D4.3X16X1.5 ZINC.	
00000178	GALV FLANGED KNURLED HEX CAP SCREW 8.8 M6x16	VITE AQ 8.8 M6X16 TE FLANG. ZIGR. ZINC. BIANCO	
00000194	GALV 10 HEX HEAD CHIPBOARD SCREW 6X20	VITE TRUCIOL. 6X20 T.ES.10 ZINDIN571	
00300017	S/S SELF-LOCKING NUT M4 LOW DIN 982	DADO AUTOBLOC INOX M4 BASSO DIN985	
03000392	BOILER SUPPORT MAC96	SUPPORTO CALDAIA MAC96 AGG.13/03/2006	
03001954	BASE ALIGNMENT PLATE 2GR APPIA	LAMIERA ALLINEAMENTO BASAMENTO2GR. APPIA	
03002530	GAUGE SUPPORT AURELIA II	STAFFA SUP. MANOM. AURELIA II	
03002990	DIN GUIDE 55mm	GUIDA TELERUTTORE DIN 55MM	
03003012	GROUP HOLDER PANEL APPIA II 2 GR	PARETE PORTAGR. 2GR. APPIA II	
03003013	GROUP HOLDER PANEL APPIA II 3 GR	PARETE PORTAGR. 3GR. APPIA II	
03003044	BOILER SUPPORT APPIA 2GR/APPIA II 2 GR-COMPACT	LAMIERA SUPPORTO CALDAIA APPIA 2GR/APPIA II 2GR-CC	
03003060	LEFT STEAM TAP SUPPORT APPIA II	SUPP. RUB. VAPORE SX STAMPATA APPIA II	
03003061	RIGHT STEAM TAP SUPPORT APPIA II	SUPP. RUB. VAPORE DX STAMPATA APPIA II	
03003097	RIGHT SIDE FRAME	FIANCO DX STAMPATO TELAIO APPIA19	
03003098	LEFT SIDE FRAME	FIANCO SX STAMPATO TELAIO APPIA19	
03003108	2GROUPS PUSHBUTTON SUPPORT	LAMIERA SUPP.INVOLUCRO COMANDI 2GR.	
03003109	3GROUPS PUSHBUTTON SUPPORT	LAMIERA SUPP.INVOLUCRO COMANDI 3GR.	
03003116	2GROUPS UPPER BACK FRAME SUPPORT	LAMIERA L SUP. POSTERIORE 2GR.	
03003117	3GROUPS UPPER BACK FRAME SUPPORT	LAMIERA L SUP. POSTERIORE 3GR.	
03003142	FRONTAL BOTTOM FRAME 3GR.	CARENA INF. FRONTALE 3GR.	
03003146	REAR BOTTOM FRAME 3GR.	CARENA INF. POSTERIORE 3GR.	
03003153	SUPPORTING BASE 3GR	BASAMENTO PORTANTE 3GR APPIA19	
03003158	SHEET L LOWER FRONT 3GR. APPIA19	LAMIERA L INF.ANTERIORE 3GR. APPIA19	
03003630	TERMINAL BLOCK SUPPORT	STAFFA SUPP. MORSETTIERA	
05000083	CABLE LOCK SR 11-2 BLACK	BLOCCACAVO SR 11-2 NERO	
05000085	CABLEGLAND TEC-S M20 D.7-14 CON DADO P-CT M20 Es	PRESSACAVO TEC-S M20 D.7-14 CON DADO P-CT M20 ES;	
05000235	TERMINAL BLOCK PROTECTION	COPRI MORSETTO CABLAGGI	
05002210	FLAT ANGULAR DRIP TRAY SUPPORT	SUPPORTO ANGOLARE PIATTO RACCOGLIACQUA	
05002490	MAIN BOARD SUPPORT BOX	SCATOLA SUPPORTO CENTRALINA	
05002492	MAIN BOARD SUPPORT COVER	COPERCHIO SCATOLA SUPPORTO CENTRALINA	
05002494	POWER RELAY SUPPORT	SCATOLA SUPPORTO TELERUTTORE	
05002502.BV	BASE 2GR WHITE	BASAMENTO 2GR. BIANCO VERNICIATO	
05002502.N	BASE 2GR BLACK	BASAMENTO 2GR. NERO	
05002502.NOV	BASE 2GR MATT BLACK	BASAMENTO 2GR. NERO OPACO VERNICIATO	

COD.	DESCRIPTION	DESCRIZIONE	VAL.
05002502.RV	BASE 2GR RED	BASAMENTO 2GR. ROSSO VERNICIATO	
05002538.BV	BOTTOM RIGHT SIDE 3GR. WHITE	FIANCO INFERIORE DX 3GR BIANCO VERN.	
05002538.NOV	BOTTOM RIGHT SIDE 3GR. MATT BLACK	FIANCO INFERIORE DX 3GR NERO OPACO VERN.	
05002538.RV	BOTTOM RIGHT SIDE 3GR. RED	FIANCO INFERIORE DX 3GR ROSSO VERN.	
05002539.BV	BOTTOM LEFT SIDE 3GR. WHITE	FIANCO INFERIORE SX 3GR BIANCO VERN.	
05002539.NOV	BOTTOM LEFT SIDE 3GR. MATT BLACK	FIANCO INFERIORE SX 3GR NERO OPACO VERN.	
05002539.RV	BOTTOM LEFT SIDE 3GR. RED	FIANCO INFERIORE SX 3GR ROSSO VERN.	
07300196	FRAME HINGE M4 ES 6	PERNO CARENA M4 ES 6	
07300391	EXTENSION CUP WARMER FASTENING	PROLUNGA FISSAGGIO SCALDATAZZE	
40000010	NUT M6 W/ WELDED GALV WASHER	DADO AQ M6 RONDELLA SALDATA ZINCATO	
40302029	RELAY SAFETY FOIL 2-3 GR.	LAMIERA SICUREZZA RELE' 2-3 GR.	
98001006	MACHINE FOOT 06 BICOMPONENT D48H40 INSERT M10	PIEDE MACCHINA 06 BICOMPONENTE D.48 H=40 INSERTO	
R98001006	KIT-MACHINE FOOT 06 BICOMPONENT D48H40 - 2Pcs	KIT-PIEDE MACCHINA BICOMPONENTE D.48 H=40 - 2Pz	
98001008	KIT TALL FEET 2006 (4 PCS.)	KIT PIEDI ALTI 2006 (4 PZ.) *KBB*	

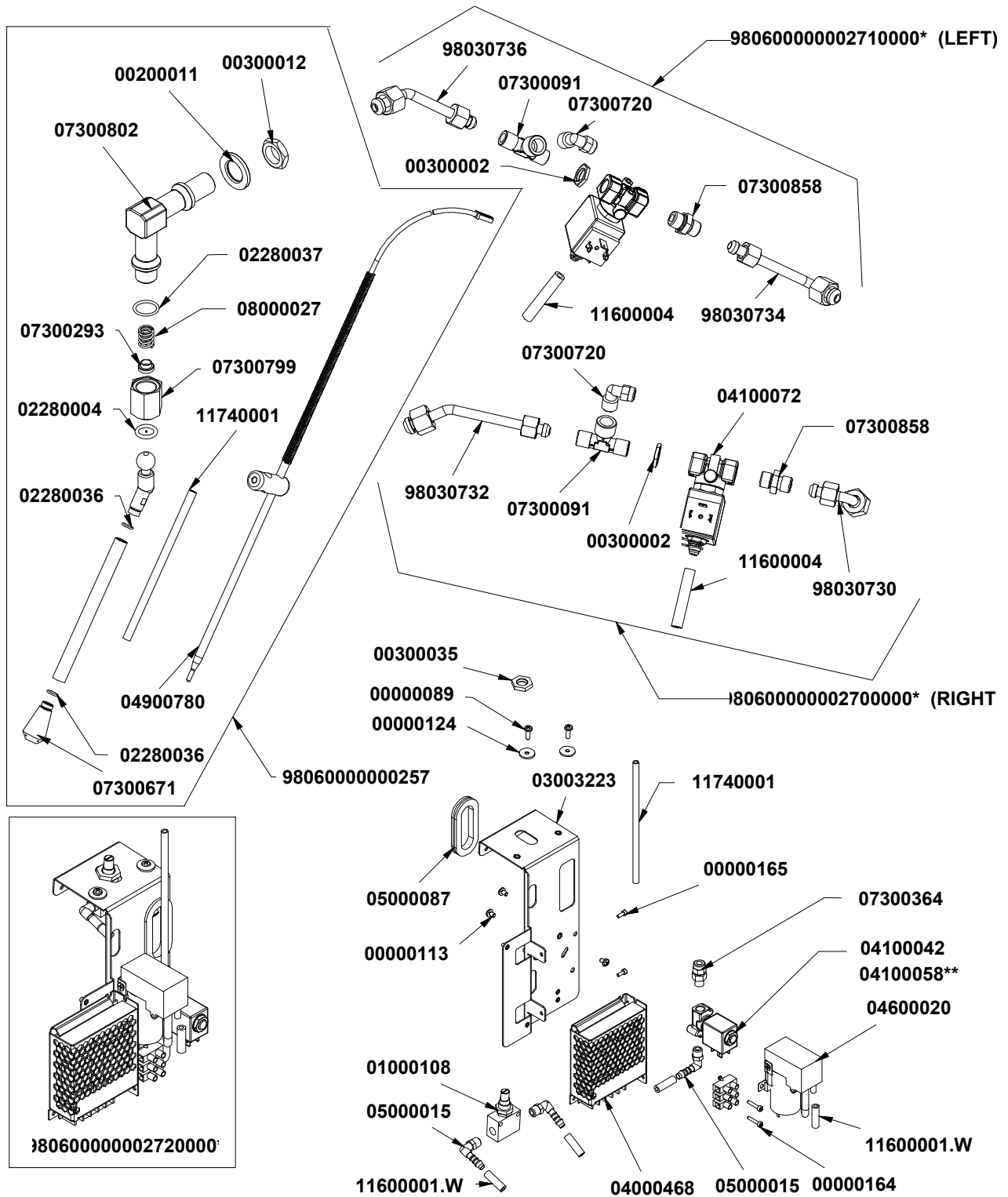

CODE	DESCRIPTION	DESCRIZIONE
04001510	Wiring Easy Cream	Cablaggio Easy Cream

* Specificare versione
Specify version

COD.	DESCRIPTION	DESCRIZIONE	VAL.
00000089	S/S CROSSHEAD CAP SCREW M4x12 DIN7985	VITE INOX M4X12 TC TCR DIN7985	
00000113	S/S CROS SHEAD CAP SCREW M4x6 7985	VITE INOX M4X6 TC T.CR. 7985	
00000124	GALV WASHER D4 3x16x1.5	RONDELLA AQ D4.3X16X1.5 ZINC.	
00000164	S/S SCREW M3x16 TCEI ISO 4762	VITE INOX M3X16 TCEI ISO 4762	
00000165	S/S SCREW M3x8 TCEI ISO 4762	VITE INOX M3X8 TCEI ISO 4762	
00200011	GALV WASHER M16 17x30x3	RONDELLA AQ M16 17X30X3 ZINC	
00300002	BRASS NUT 1/4 D3 CH18	DADO OT 1/4 SPESS.3 CH18 AGG. 22.07.96	
R00300002	KIT-BRASS NUT 1/4 D3 - 15Pcs	KIT-DADO OT 1/4 SPESS.3 - 15Pz	
00300012	BRASS NUT 3/8 GAS D6 CH22 ADD 22.07.96	DADO OT 3/8 GAS CH22 SPESS.6 AGG. 22.07.96	
00300035	NUT M12X1 CH19	DADO OT M12X1 CH19 X FISSAGGIO VALVOLA GAS	
01000108	TAP MRF 1/8 FF 604	RUBINETTO MRF 1/8 F-F 604	
R01000108	KIT-TAP MRF 1/8 FF - 1Pcs	KIT-RUBINETTO MRF 1/8 F-F - 1Pz	
02280004	GASKET O RING 115 D17 EP 856 x SWIVEL STEAM PIPE	GUARN. OR 115 D.17 EP856 SNODO LANCIA	
R02280004	KIT-GASKET O RING 115 D17 EP 856 x STEAM PIPE - 55Pcs	KIT-GUARN. OR 115 D.17 EP856 SNODO LANCIA - 55Pz	
02280036	O RING STEAM WAND NOZZ. D6x1.2 EPDM70	GUARN. OR BECCO LANCIA VAP. DI 6X1.2 EPDM70	
R02280036	KIT-O RING FOR STEAM WAND NOZZLE D6x1.2 EPDM - 65Pcs	KIT-GUARN. OR x BECCO LANCIA VAP. D. 6x1.2 EPDM- 65Pz	
02280037	GASKET O RING JOINT LOCK 16x2 NBR70	GUARN. OR CHIUSURA SNODO 16X2 NBR70	
R02280037	KIT-GASKET O RING JOINT LOCK 16x2 NBR - 45Pcs	KIT-GUARN. OR CHIUSURA SNODO 16x2 NBR - 45Pz	
03003223	COMPRESSOR SUPPORT PLATE VA358	LAMIERA SUPPORTO COMPRESSORE VA388	
04000468	TRANSFORMER 24VDC 50W OPTIONAL	TRASFORMATORE 24V 50W OPTIONALS	
R04000468	KIT-TRANSFORMER 24VDC 50W Opt. - 1Pcs	KIT-CAVO ALIMENT. 3x1,5 SPINA UK 2mt - 1Pz	
04001510	EXTRA WIRING EASYCREAM APPIA19	SUPPL. CABLAGGIO EASY CREAM APPIA19	
04100042	2WAY SOLENOID 1/8-1/8 220-230V50/60Hz F2 CE	E.V. NC 2VIE 1/8-1/8 220-230V 50/60HZ VITON F2 CE	
R04100042	KIT-2WAY SOLENOID 1/8-1/8 220-230V50/60Hz F2 CE - 1Pcs	KIT-E.V. NC 2VIE 1/8-1/8 220-230V 50/60HZ VITON F2- 1Pz	
04100058	2WAY SOLENOID 1/8-1/8 208-240V 60Hz F2 UL TH2xM3	E.V. NC 2VIE 1/8-1/8 208-240V 60HZ VITON F2 UL PIEDINO F	
04100072	3WY SOLENOID 1/4-1/4 DISCHARGE 1/8 208/240V	E.V. NC 3VIE 1/4-1/4 SCAR.1/8 208/240V 50/60HZ F5 INOX	
04600020	MICROCOMPRESSOR EASYCREAM	MICROCOMPRESSORE X EASY CREAM	
04900780	PROBE PT1000 STEAMWAND TURBOCREAM D06 +SUP A	SONDA PT1000 X LANCIA VAPORE "TURBO CREAM" D06 +	
05000015	TUBE FASTENING WES 6R 1/8	RACCORDO PORTATUBO WES 6R 1/8	
05000087	CABLE DUCT PVC OVALE NERO OV7	PASSACAVO PVC OVALE NERO OV7	
07300091	T FITTING MFM 1/4 CYLIN.	RACCORDO T 1/4 M-F-M CILIN.	
07300293	ARTICULATED BUSHING AG.25.06.96 OT-57	BUSSOLA SNODO AG.25.06.96 OT-57	
R07300293	KIT-ARTICULATED BUSHING - 15Pcs	KIT-BUSSOLA SNODO - 15Pz	
07300364	STRAIGHT FITTING 1/8 M CON. - FITTING.6 340	RACCORDO DIR. 1/8 M CON. - CALZAM.6 340	
R07300364	KIT-STRAIGHT FITTING 1/8 M CON. - FITTING.6 340 - 8Pcs	KIT-RACCORDO DIR. 1/8 M CON. - CALZAM.6 - 8Pz	
07300636	STEAM WAND PIPE L=118	TUBO LANCIA INOX VAPORE L=118	
07300671	EASYCREAM NOZZLE 4HOLES TALENTO - AURELIA II	BECCO EASYCREAM 4 FORI TALENTO / AURELIA II	
07300720	L FITTING 1/4 M - FITTINGS	RACCORDO L 1/4 M - CALZAM.	
07300799	NUT FITTING 3/8 H=26 S/S ARTICULATED WAND	DADO RACC. 3/8 H=26 LANCIA SNODATA INOX	
07300802	ATTACHMENT HOT WATER TAP/AUTOSTEAM	ATTACCO RUB. ACQUA/AUTOSTEAM AURELIA II OT-57	
07300858	FITTING 1/4M-1/4M OT-57 USA	RACCORDO 1/4M-1/4M OT-57 USA	
R07300858	KIT-FITTING 1/4M-1/4M - 15Pcs	KIT-RACCORDO 1/4M-1/4M - 15Pz	
08000027	WAND SPRING	MOLLA PER LANCIA SNODATA	
11600001.W	WHITE SILICONE PIPE 4x7,5 60Sh(1mt=41gr)	TUBO SILICONE BIANCO4X7,5 60SH(1MT=41GR)	
11600004	SILICONE PIPE 5x9 60Sh PEROX	TUBO SILICONE 5X9 60SH PEROX BIANCO (1MT=50GR)	

COD.	DESCRIPTION	DESCRIZIONE	VAL.
11740001	TEFLON PIPE 6/4	TUBO TEFLON 6/4	
98030730	WATER MIXER-HOT WATER WAND PIPE 2-3GR.	TUBO CALDAIA-E.V. EASY CREAM DX APPIA19 2-3GR.	
98030732	BOILER-HOT WATER VALVE PIPE 2-3GR.	TUBO E.V. EASY CREAM - LANCIA DX APPIA19 2-3GR.	
98030734	BOILER-EASYCREAM VALVE LEFT PIPE 2-3GR.	TUBO CALDAIA-E.V. EASY CREAM SX APPIA19 2-3GR.	
98030736	EASYCREAM VALVE-STEAM WAND LEFT PIPE 2-3GR.	TUBO E.V. EASY CREAM - LANCIA SX APPIA19 2-3GR.	
98060000000257	ATTACHMENT + EASYCREAM WAND W/ PROBE SET APP	ASS. ATTACCO + LANCIA EASY CREAM CON SONDA APPIA/	
980600000002700001	SOLENOID + RIGHT STEAM TUBES SET RIGHT EC	ASS. E.V. + TUBI VAPORE DX EASY CREAM DX	
980600000002710001	SOLENOID + LEFT STEAM TUBES SET EC LEFT	ASS. E.V. + TUBI VAPORE SX EASY CREAM SX	
980600000002720001	SUPPORT + EASYCREAM SOLENOID SET CE	ASS. SUPPORTO+ E.V. EASY CREAM CE	
980600000002720002	SUPPORT + EASYCREAM SOLENOID SET CSA	ASS. SUPPORTO+ E.V. EASY CREAM CSA	
980600000002720003	SUPPORT + EASYCREAM SOLENOID SET 115V	ASS. SUPPORTO+ E.V. EASY CREAM 115V	

VOL

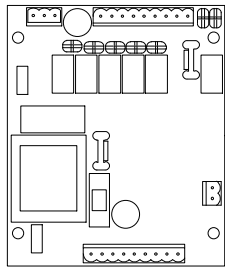

04901430

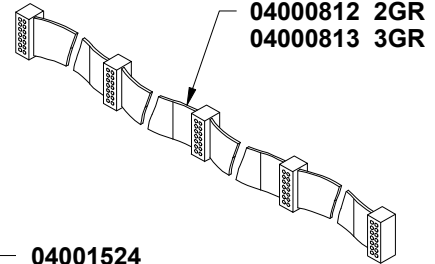

04000812 2GR
04000813 3GR

XT

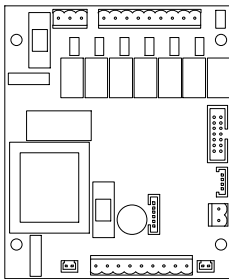

04901432

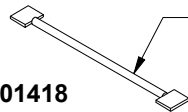

04001524

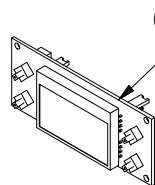

04901418

SEM

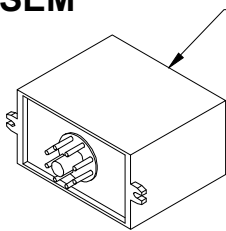

09000015
09000015.UL**

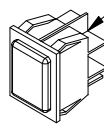

04200012



04200116



04200118

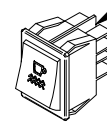

04200120

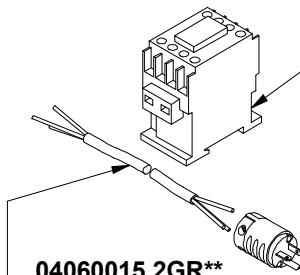

04200019

04060015 2GR**
04060014 3GR**

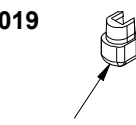

05000083

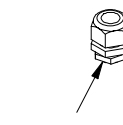

05000085

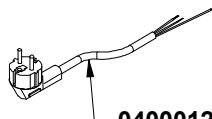

04000126 230V 2GR 3000W

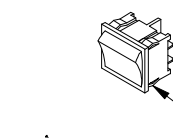

04200057

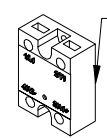

04200096
Easy Cream



04000543 400V
04000542 230V 2GR 4500W

ELECTRICAL COMPONENTS

CODE	DESCRIPTION	DESCRIZIONE
04001510	Wiring Easy Cream	Cablaggio Easy Cream
04001512	Wiring SEM 2GR	Cablaggio SEM 2GR
04001517	Wiring VOL 2GR	Cablaggio VOL 2GR
04000340	Bridge transf. 380V - 220V	Ponticello transf. 380V - 220V
04000806	Cup warmer wiring	Cablaggio scaldatasse
04000807.P	Push-button wiring SEM 2GR	Cablaggio puls. SEM 2GR
04000809.P	Push-button wiring SEM 3GR	Cablaggio puls. SEM 3GR

**Mercato Nord America
North America Market

COD.	DESCRIPTION	DESCRIZIONE	VAL.
04000126	ELECTRIC CABLE 2MT CE SCHUKO PLUG 90° 3X1,5	CAVO ELETTR. 2MT CE SPINA SCHUKO 90° 3X1,5 H05VV-F	
04000340	BRIDGE TRANSFORMATION 380V TO 220V AURELIA-APPIA	PONTICELLO TRASF. ALIMENTAZ. DA 380V A 230V AURELIA	
04000542	ELECTRICAL CABLE 3x4 H07RN-F 2mt450/750V CB ICEL	CAVO ELETTR. 3X4 H07RN-F 2MT450/750V CB -> ICEL <-	
04000543	ELEC. CABLE 5x2,5 H07RN-F CB450/750V 2,5mt ICEL	CAVO ELETTR. 5X2,5 H07RN-F CB450/750V 2,5MT ICEL	
04000806	WIRING CUPWARMER 2-3 GR APPIA	CABLAGGIO SCALDATAZZE 2-3 GR. APPIA	
04000807.P	WIRING PUSH-BUTTON PANEL 2/3 GR APPIA S	CABLAGGIO PULSANTIERA 2 GR APPIA S	
04000809.P	WIRING PUSH-BUTTON PANEL 3 GR S APPIA	CABLAGGIO PULSANTIERA 3 GR. S APPIA	
04000812	CABLE 14 WAY KEYPAD 2GR APPIA + SHEATH	CAVO 14 VIE COLL.PULSANTIERA 2GR APPIA + GUAINA	
R04000812	KIT-CABLE 14 WAY KEYPAD 2GR + SHEATH - 2Pcs	KIT-CAVO 14 VIE COLL.PULSANTIERA 2GR - 2Pz	
04000813	CABLE 14 WAY KEYPAD 3GR APPIA + SHEATH	CAVO 14 VIE COLL.PULSANTIERA 3GR APPIA + GUAINA	
R04000813	KIT-CABLE 14 WAY KEYPAD 3GR + SHEATH - 2Pcs	KIT-CAVO 14 VIE COLL.PULSANTIERA 3GR - 2Pz	
04001510	EXTRA WIRING EASYCREAM APPIA19	SUPPL. CABLAGGIO EASY CREAM APPIA19	
04001512	COMPLETE WIRING 2GROUPS SEM VERSION	CABLAGGIO COMP. 2GR S	
04001517	COMPLETE WIRING 2GROUPS VOL VERSION	CABLAGGIO COMP. 2GR V	
04001524	CONN CABLE DISPLAY-CENTRAL BOARD APPIA19	CAVO COLL. DISPLAY-CENTRALINA APPIA19	
04060014	CABLE+PLUG AWG3x12 SJO UL/CSA 30A 250V	CAVO ALIM. AWG3X12 SJO 90°C UL/CSA 2MT	
04060015	CABLE+PLUG AWG3x14 SJO UL/CSA 20A 250V NEMA 6-2C	CAVO ALIM. AWG3X14 SJO 90°C UL/CSA 2MT SPINA USA D	
04200012	RED FLASHING SEGNA SYSTEM UL	SEGNALATORE LUMINOSO ROSSO RETTANGOLARE UL	
04200019	4POLE CONTACTOR 25A CE/UL 230V COIL	CONTATTORE QUADRIPOLE 25A CE/UL BOBINA 230V	
R04200019	KIT-4POLE CONTACTOR 25A CE/UL 230V COIL - 1Pcs	KIT-CONTATTORE QUADRIPOLE 25A CE/UL BOBINA 230V	
04200057	DBL POWER BIPOLAR BIG SWITCH 10A UL 22X19	INTERRUT. ACCENSIONE BIPOL. GRANDE 10A UL 22X19	
R04200057	KIT-DBL POWER BIPOLAR BIG SWITCH 10A UL 22X19 - 1Pcs	KIT-INTERRUT. ACCENSIONE BIPOL. GRANDE 10A UL 22x19	
04200096	STATIC RELAY 25A 250V 1OUT	RELE' STATICO 25A 250V 1OUT	
04200116	BLUE LIGHT WHITE BIPOLAR SWITCH UL 16A COFFEE	INTERRUTTORE BIPOLARE LUMINOSO BIANCO RETTANGOLARE UL	
04200118	BLUE LIGHT WHITE BIPOLAR SWITCH UL 16A HOTWATER	INTERRUTTORE BIPOLARE LUMINOSO BIANCO RETTANGOLARE UL	
04200120	BLUE LIGHT WHITE BIPOLAR SWITCH UL 16A CUPWARMER	INTERRUTTORE BIPOLARE LUMINOSO BIANCO RETTANGOLARE UL	
04901418	DISPLAY BOARD APPIA19 XT	SCHEDA DISPLAY APPIA19 XT	
04901430	UNIVERSAL CENTRAL BOARD 230V APPIA LIFE	CENTR. UNIVERSALE APPIA LIFE 230V	
04901432	UNIVERSAL CENTRAL BOARD 115-240V APPIA LIFE XT	CENTRALINA UNIVERSALE APPIA LIFE XT 100-240V	
05000083	CABLE LOCK SR 11-2 BLACK	BLOCCACAVO SR 11-2 NERO	
05000085	CABLEGLAND TEC-S M20 D.7-14 CON DADO P-CT M20 Es	PRESSACAVO TEC-S M20 D.7-14 CON DADO P-CT M20 ES	
09000015	AUTOLEVEL CONTROL BOARD 230V	CENTRALINA AUTOLIVELLO 230V	
09000015.UL	AUTOLEVEL CONTROL BOARD UL 230V	CENTRALINA AUTOLIVELLO UL 230V	

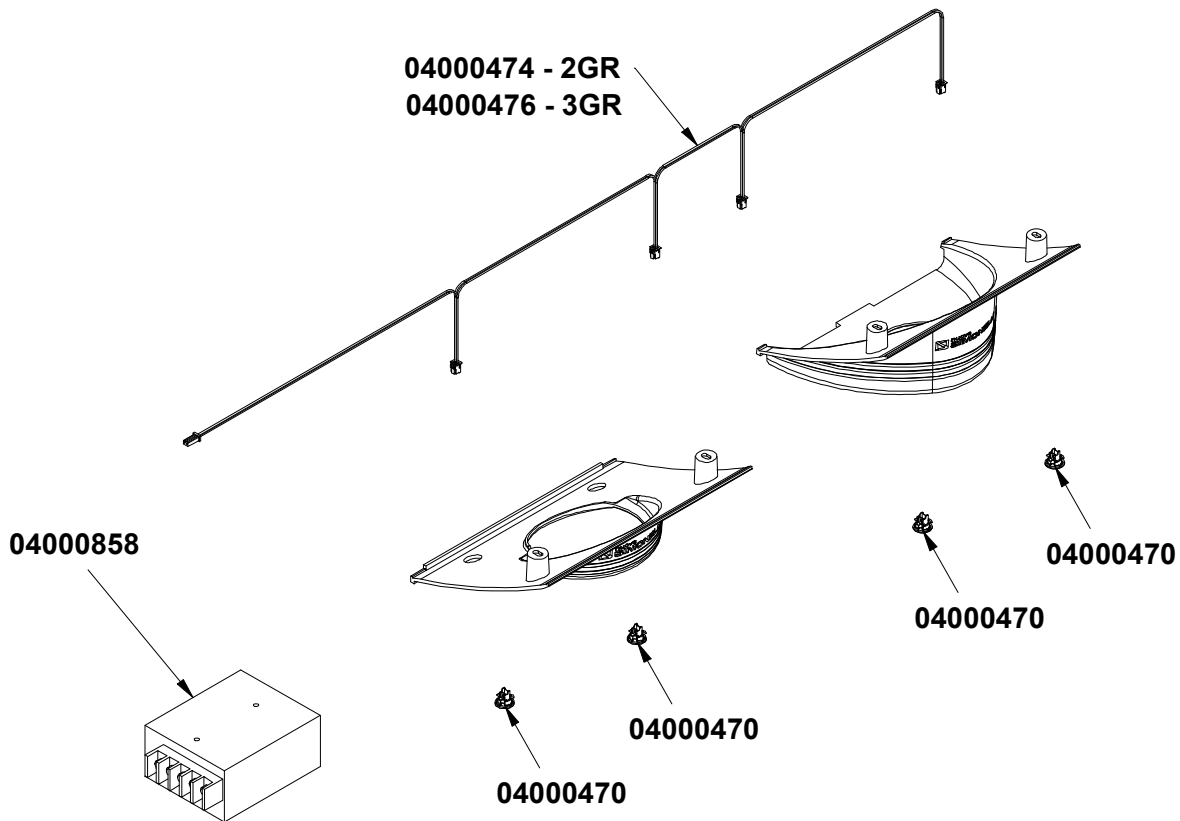

CODE	DESCRIPTION	DESCRIZIONE
04000474	Lights wiring 2GR	Cablaggio luci 2GR
04000476	Lights wiring 3GR	Cablaggio luci 3GR
04001508	Lights power supply wiring	Cablaggio alim. luci

COD.	DESCRIPTION	DESCRIZIONE	VAL.
04000470	12VDC LED SPOT AURELIA WAVE	LED AURELIA18 12V	
04000474	GROUP LIGHTS WIRING AURELIA WAVE 2GR	CABLAGGIO LUCI GRUPPI EROGAZ. 2GR. AURELIA18	
04000476	GROUP LIGHTS WIRING AURELIA WAVE 3GR	CABLAGGIO LUCI GRUPPI EROGAZ. 3GR. AURELIA18	
04000858	TRASF. LED RETRO IN:100/240V OUT:12V CE/UL 15W	TRASF. LED RETRO IN:100/240V OUT:12V CE/UL 15W RS-1	
R04000858	KIT-TRASF. REAR LED IN:100/240V OUT:12V CE/UL - 1Pcs	KIT-TRASF. LED RETRO IN:240V OUT:12V CE/UL 15W- 1Pz	
04001508	WIRING LIGHT TRANSFORMER-WIFI	CABLAGGIO ALIMENTAZ.TRASF.LUCI-WIFI	

www.nuovasimonelli.it

Simonelli Group

Via E. Betti, 1
62020 Belforte del Chienti
Macerata - Italy
T +39 07339501
info@simonelligroup.it
www.nuovasimonelli.it

Nuova Distribution Usa

6940 Salashan Pkwy, Bldg, A
Ferndale, WA 98248
T +1 3603662226
info@simonelliusa.com
www.simonelliusa.com

Nuova Simonelli Asia Pacific

61 Kaki Bukit Ave 1
#02-24 Shun Li Industrial Park
Singapore 417943
T +65 68410985
www.nuovasimonelliasiapacific.com

Nuova Distribution France

Hexapole - Actipole - Bat 5
Rue Maurice Herzog
73420 Viviers Du Lac
T +33 (0) 967894852
info@nuovadistribution.fr