



⚠️ WARNING

CHOKING HAZARD

Small parts can be swallowed and block the airway. Cotton rope can wrap around the neck and pose a strangulation hazard. Do not allow children under the age of 3 to use this product. Use adult supervision at all times.

FIRE HAZARD

Keep all flame and heat sources away from teepee fabric.

Assembly and usage guidelines:

- Adult assembly required
- Adult supervision required at all times
- Ages 3+

📷 @tinylandus 📱 @tinylandtoy 🏠 www.tinylandus.com ✉ customer_care@tinylandus.com

Parts List

A X 8

Upper/Lower Wood Poles

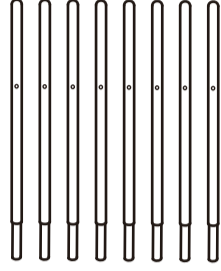

B X 8

Middle Wood Poles

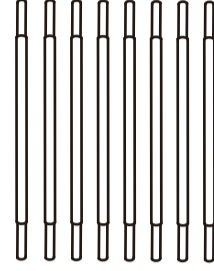

C X 12

Connector Tubes

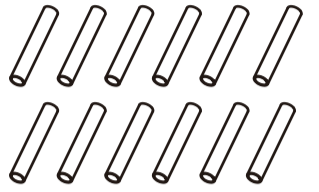

D X 1

Cotton Rope 4.8 ft

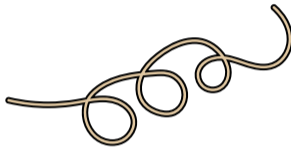

E X 1

Teepee Fabric

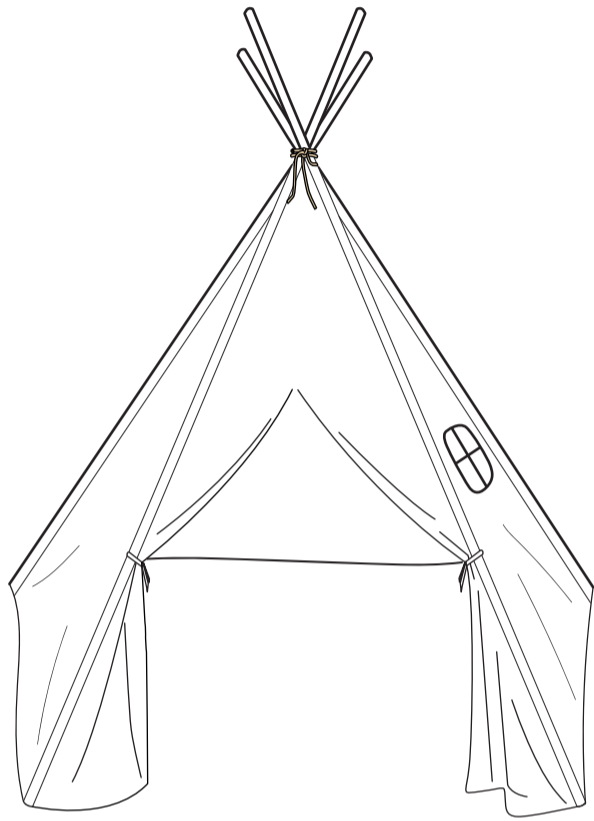
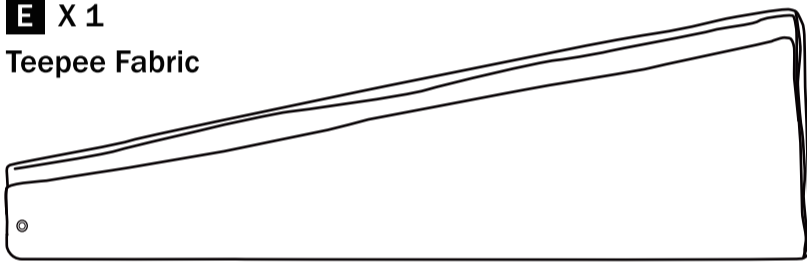

⚠️ Note : It's best to lay the tent flat on the clean mat to assemble it.

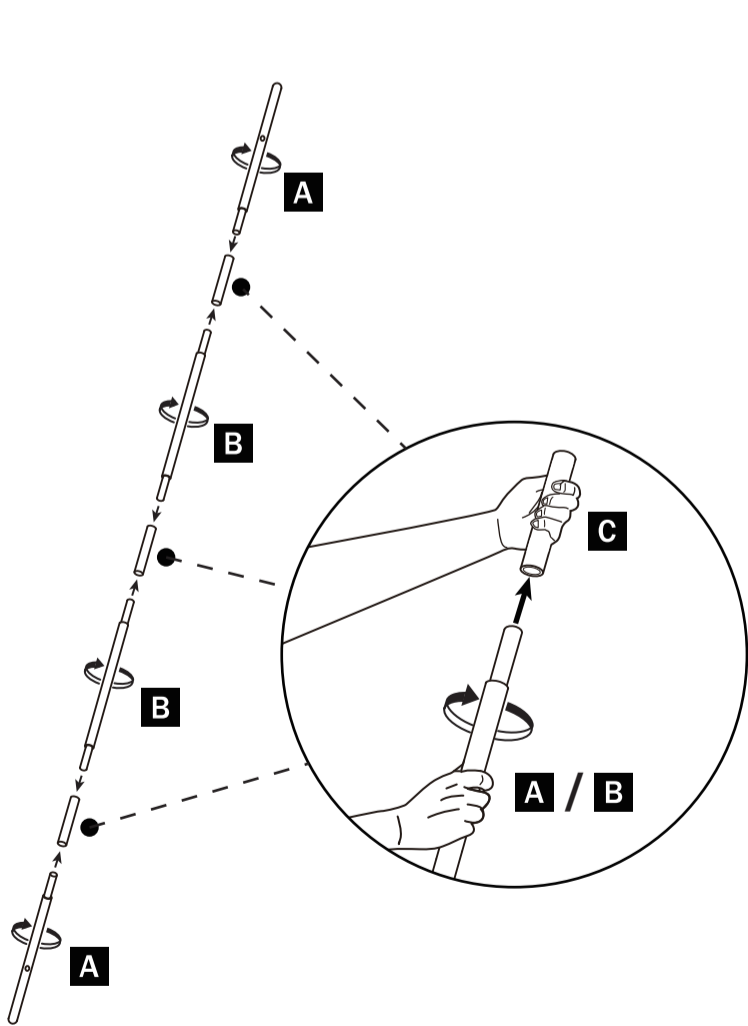

❶ To begin assembly, rotate the pole to insert it into the connector until they are fully connected. One set of pole contains two short pole **A**, two short pole **B**, and three connectors **C**. Repeat until all four poles are assembled.

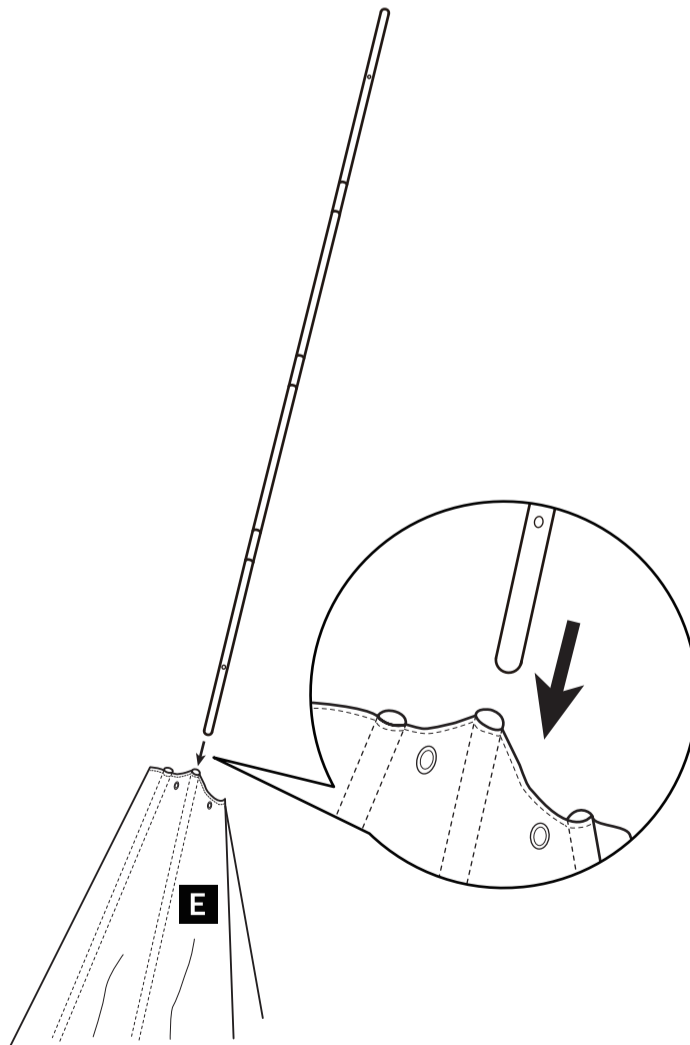

❷ Slide fully assembled poles into the pole sleeves located on the teepee fabric **E**. Slide each pole to the base of the canvas sleeves.

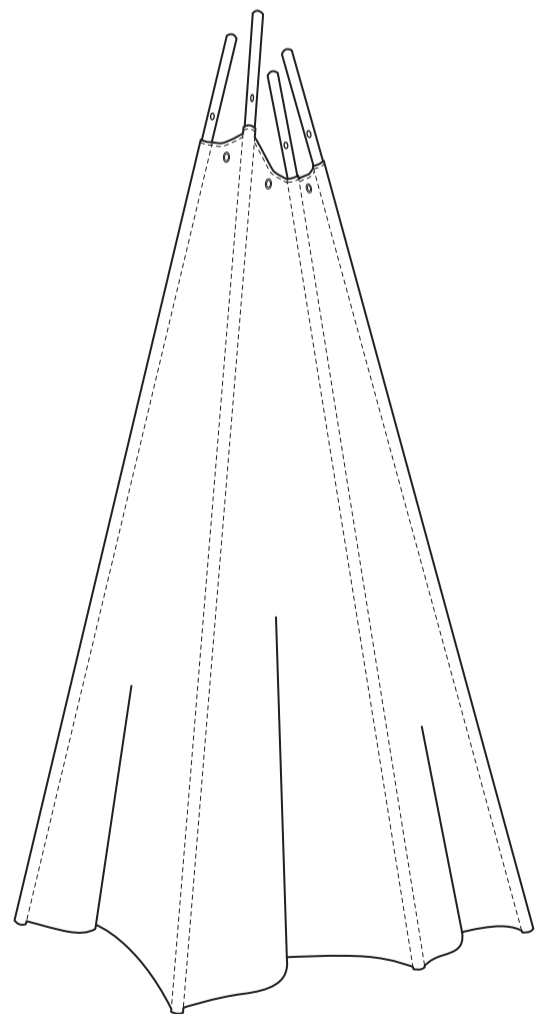

❸ Make sure all of the poles are inserted to the bottom, the sleeve should not be wrinkled.

⚠ Note: The steps of tying of rope are quite crucial to the stability of the teepee. The incorrect tether may cause the teepee to be unstable.

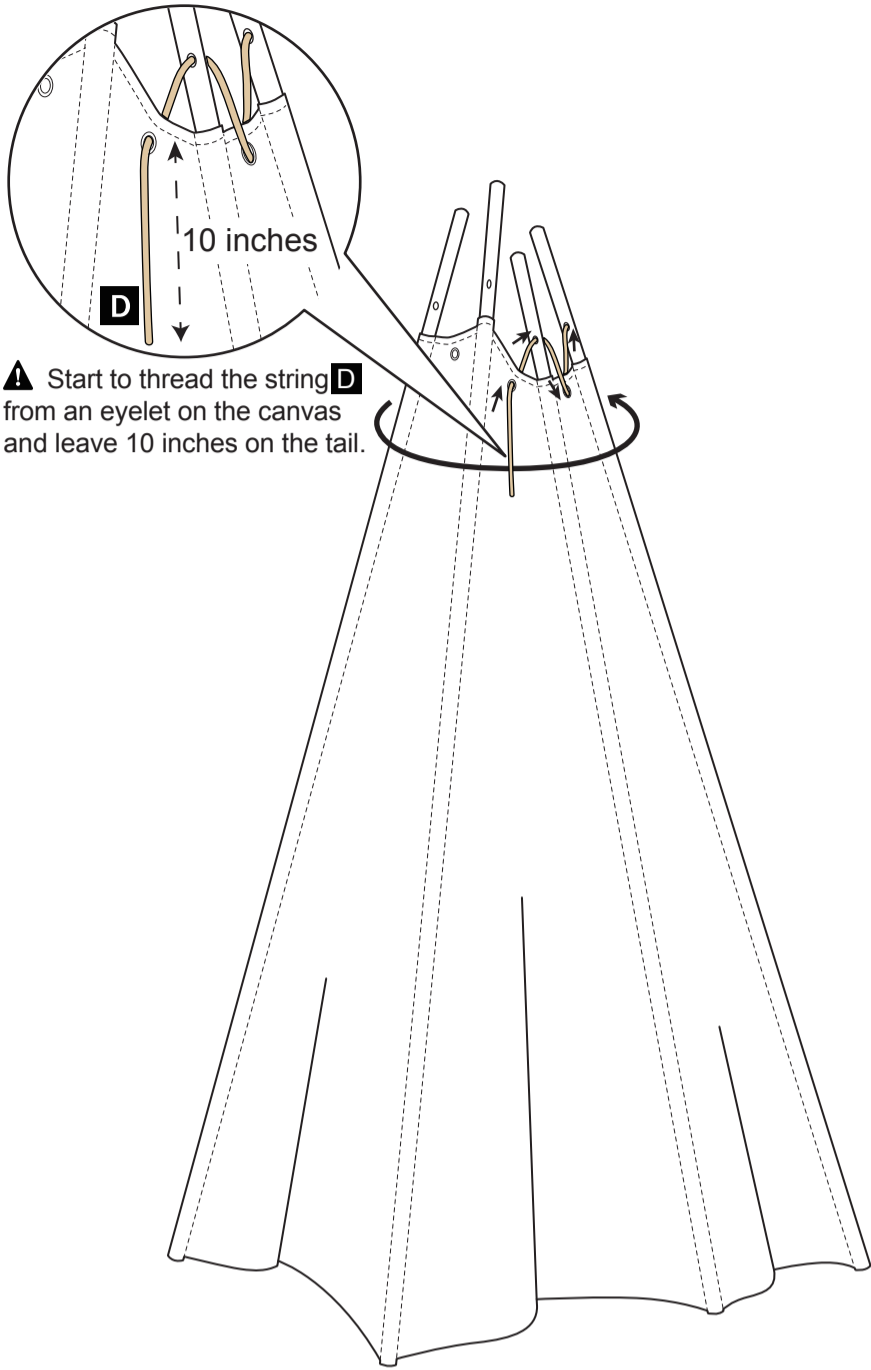

⚠ Start to thread the string **D** from an eyelet on the canvas and leave 10 inches on the tail.

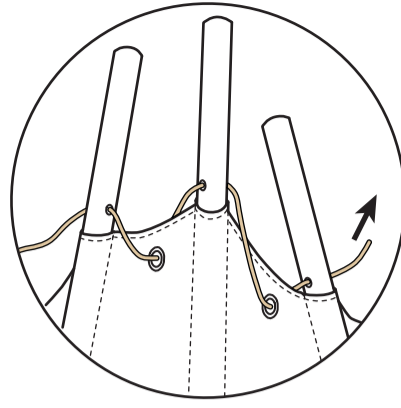

4 Attach wood poles and teepee canvas using the cotton rope. Thread the rope through the eyelets on the canvas and then through the pole, alternating each time (keeping all poles bunched together).

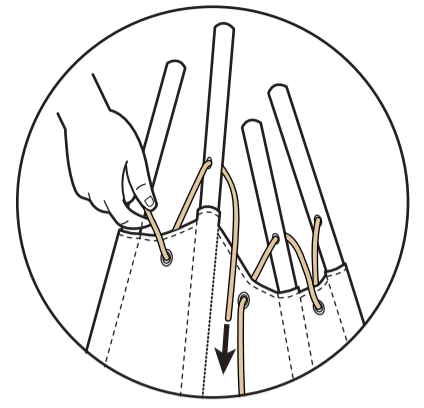

5 Tighten the rope between the pole and the fabric like tightening a shoelace.

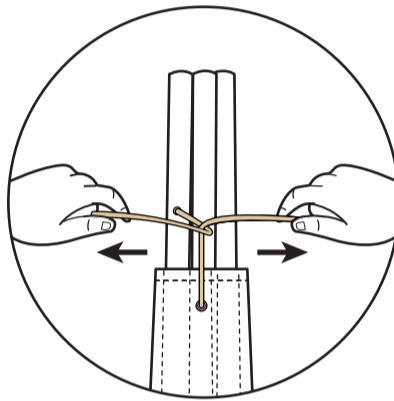

6 Tighten the rope by tying it in a knot.

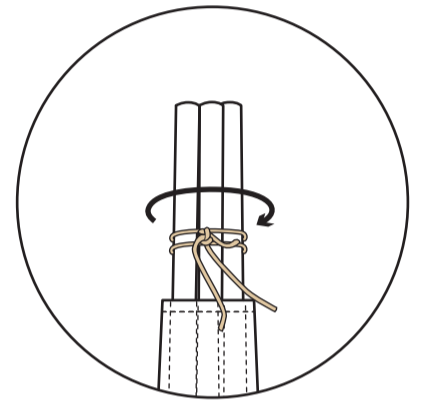

7 Wrap the poles a lap with the rope and tie the knot at the end. Be sure to tighten the rope.

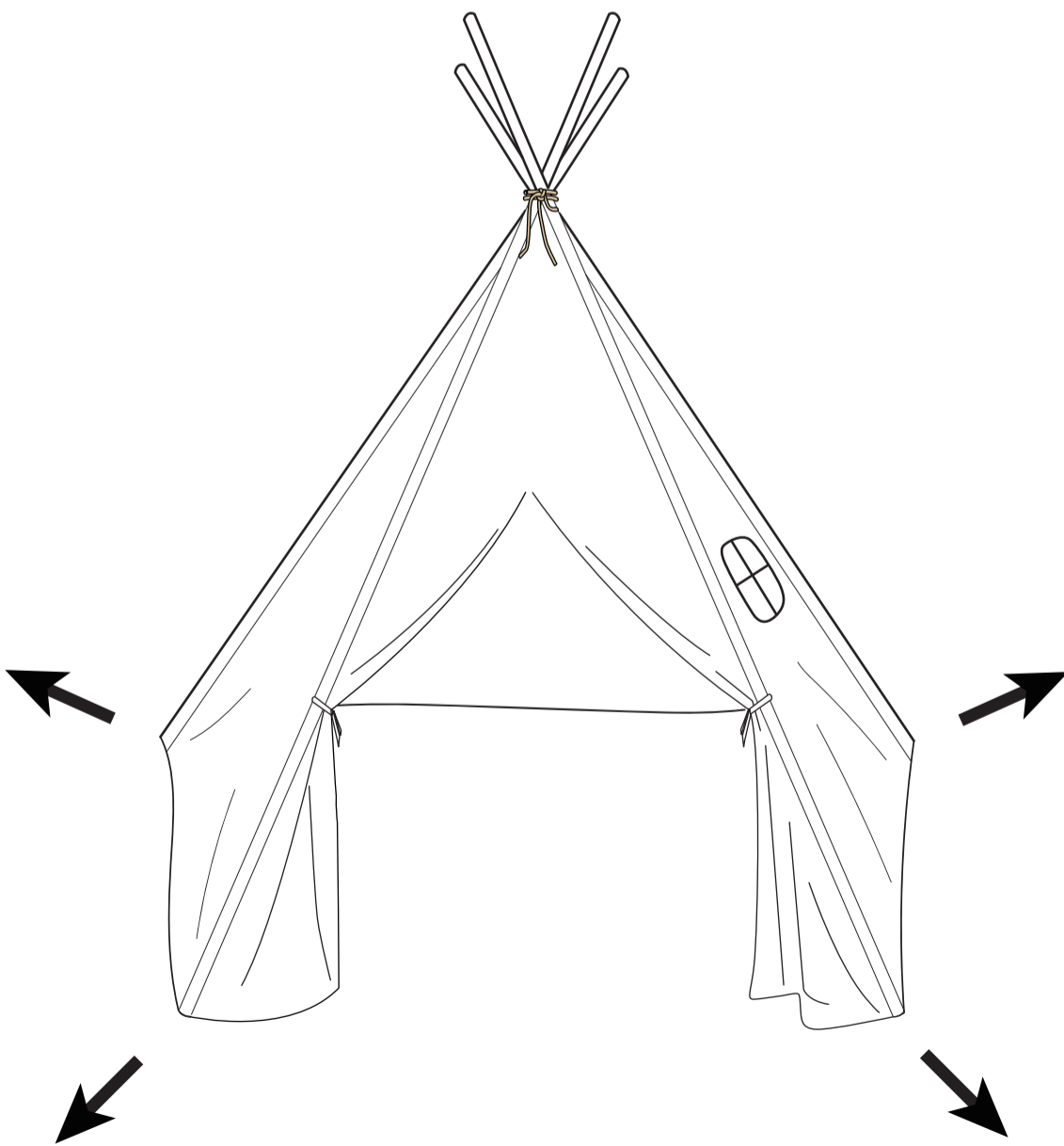

8 Take the tent to the place where you want to place it, then stand it up. Ensure all teepee poles are fully extended and the fabric in each section is tight. The fabric should not sag between poles if all poles are fully extended. Enjoy!

Poles:

- When the poles or connectors come snapped or broken, discard them! Contact us through customer_care@tinylandus.com immediately and get replacements.