



**Spring Axle
Owner's Manual**

Spring/Hub Axles for Marine and Utility Trailers



Table of Contents	Page
Slipper Springs	2
Double Eye Springs	3
Inspecting Springs	4
Replacing Springs	5
Tire Tread Wear	6-7
Super Lube Hub Maintenance	8
Standard Hub Maintenance	9
Axle Warranty	10

This manual covers Spring Axles and Hubs only. TIE DOWN ENGINEERING offers drum brakes and disc brakes and other specialty products, too many to include in this manual. If you have brakes on your axles please visit our web site, www.tiedown.com. In the downloads section you can find fully detailed owners manuals for all brake types offered by TIE DOWN ENGINEERING.



This manual provides general service and maintenance procedures. Many variables can change the circumstances of the service procedure, i.e., the degree of difficulty involved in the service operation and the ability level of the individual performing the operation. This manual cannot begin to plot out procedures for every possibility, but will provide the general instructions for effectively servicing the vehicle. In the event the skill level required or the procedure to difficult, a certified technician should be consulted before performing the necessary service. Failure to correctly service the vehicle may result in voiding the warranty, inflicting injury or even death. The owner's manual for your axle may have more procedures for service and maintenance.

TIE DOWN ENGINEERING

www.tiedown.com

255 Villanova Drive SW, Atlanta, GA 30336

(404) 344-0000 • Fax (404) 349-0401

© 2015 TIE DOWN Inc., ALL RIGHTS RESERVED

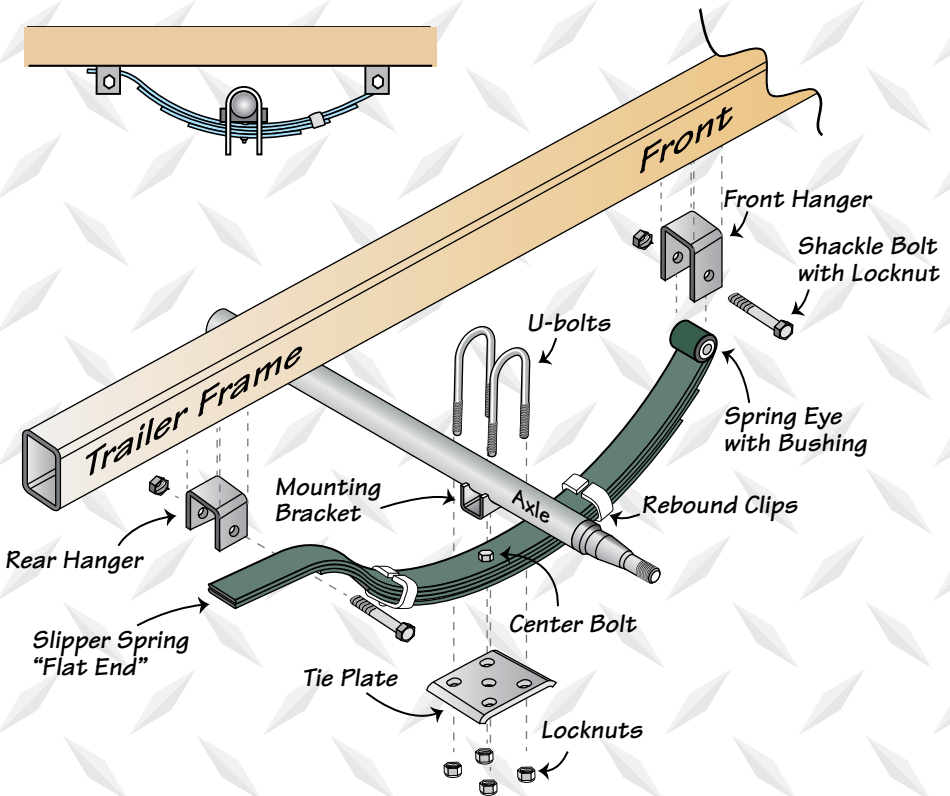

Differences Between Slipper Spring Systems and Double-Eye Spring Systems

- Shape of spring
- Weight capacity of slipper springs is generally greater than double-eye springs
- Fewer moving parts on slipper spring suspensions, thus fewer parts to maintain
- Slipper spring systems ride a little more roughly than double-eye spring systems



Radius End Slipper Spring

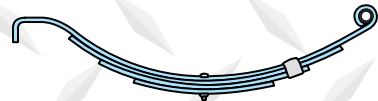

Hook End Slipper Spring



Flat End Slipper Spring

Double Eye Springs

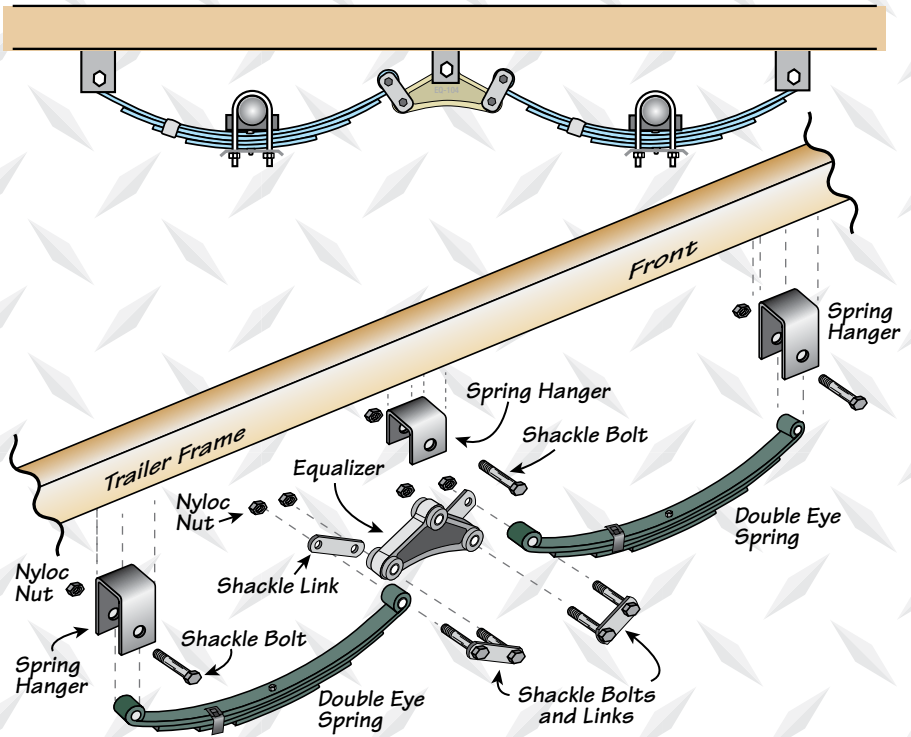

Double Eye Leaf Springs

Double Eye Leaf Springs have eyes at both ends of the spring assembly with nylon bushings to assist in preventing wear. U-bolts hold the springs to the axle with a plate. The articulation of this suspension occurs when the eyes rotate on the wear surfaces provided in eyes of the springs and on the equalizers. This suspension is also available in single and multiple axle configurations. In trailers with 2 or more axles, the additional movement is maintained by an equalizer. This feature allows for even load handling from axle to axle.



Double Eye Spring

Equalizers

The equalizer allows for a smooth transfer of the impact through the suspension system under the trailer. Used for multi-axle systems, equalizers are designed to transfer from one axle to another the additional load resulting from bumps. The transfer of load serves to equalize the weight being carried by all axles at the time of impact. Without an equalizer, going over a bump would cause one axle to have a disproportional amount of weight on it.

Springs should be replaced if:

- * Cracked
- * Broken
- * Extremely rusty
- * Overly worn and sagging
- * You are upgrading the axle to a greater weight capacity

Replacing springs protects the trailer and its contents from:

- ◆ Extra wear and tear
- ◆ Poor trailer handling
- ◆ Limited ground clearance

To replace springs you need to know the following:

- ✓ Number of leaves
- ✓ Width of spring
- ✓ Length of spring
- ✓ Weight rating of axle (to determine weight load for each spring)

Useful dimensions to have when replacing slipper springs

A = Length from center of the eyes to the end of the slipper spring. Allow for slight variations in the measurement, because the spring can sag and elongate as a result of wear. Note "A" is the most critical dimension to record when replacing springs.

B = Length from center of eye to highest point of slipper end

C = Height from top center of spring to center of eye

D = Length from center of eye to middle of the spring

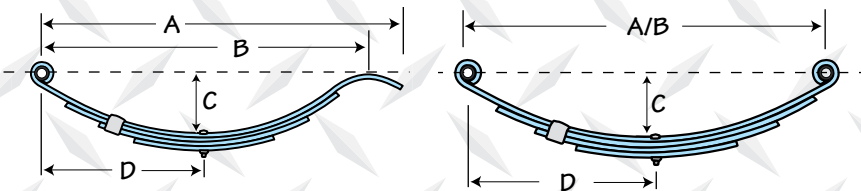

Replacing Springs

VERY IMPORTANT: If you are building a new boat/utility trailer frame:

Axles must be “square” to the frame. The spring hangers must be welded/ attached at the same distance from the rear or front of the trailer. Failure to do so will result in a trailer that will travel at an angle when towed.

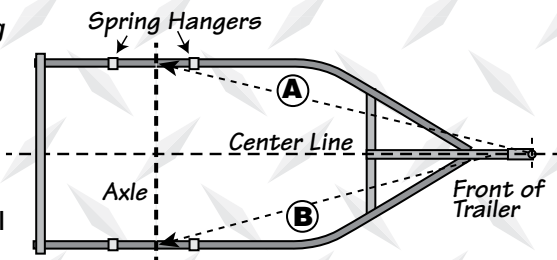

“A” dimension must equal **“B”** dimension

- New springs come with a bushing in the eye of the springs
- All springs should be replaced at the same time Ideal for maintaining even support for the trailer
- Overall spring weight rating should not be greater than the trailer’s weight capacity. If it is:
 - 1 - This will result in a stiffer ride for the trailer, especially when unloaded.
 - 2 - You cannot use the full capacity of the springs because you can only haul as much as the trailer is rated.

All the components of your suspension system should be visually inspected for signs of wear, damage or loose fasteners at least every 6,000 miles.

If any components need replacing use the following method:

1. Support the trailer with the wheels just off the ground. Follow the trailer manufacturer’s recommendations for lifting and supporting the unit.
2. After the unit is properly supported place a suitable block under the axle tube near the end to be repaired. This block is to support the weight of the axle only to allow suspension components to be serviced or replaced.
3. Disassemble the U-bolts, nuts, and tie plates.
4. Remove the spring eye bolts and the spring.
5. If the spring eye bushings are to be replaced, press out the old bushing by hand or tapping out with a punch.
6. Free-floating nylon bushing needs no lubrication. Press the new bushing into the spring eye by hand or gently tapping it in with a bounce-less rubber or plastic mallet.
7. Reinstall repaired items or replaced components in reverse order.

Note: For multiple axle units, the weight of each axle must be supported as outlined in Step 2 before disassembly of any component of the suspension system.

The way your tires wear is a good indicator of proper or improper towing of your trailer. Abnormal wear patterns are often caused by the need for simple tire maintenance, or alignment. Tires should be inspected at every opportunity; once a week isn't too often. Learning to read the early warning signs of trouble can prevent wear that shortens tire life or indicates the need for having other parts of the trailer serviced. Tires should be inspected 3 ways. First, visually examine all tires; second, feel the tread by hand to detect wear such as feathering and third, check all tires with a pocket type pressure gauge.

Over Inflation

Excessive wear at the center of the tread indicates that the air pressure in the tire is consistently too high. The tire is riding on the center of the tread and wearing it prematurely. Many times, the "eyeball" method of inflation (pumping the tires up until there is no bulge at the bottom) is at fault; tire inflation pressure should always be checked with a reliable tire gauge. Occasionally, this wear pattern can result from outrageously wide tires on narrow rims. The cure for this is to replace either the tires or the wheels.

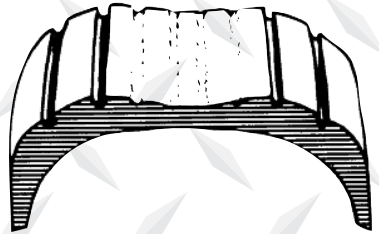

Under Inflation

This is the most common problem in trailers. This type of wear usually results from consistent under inflation. When a tire is under inflated, there is too much contact with the road by the outer treads, which wear prematurely. Tire pressure should be checked with a reliable pressure gauge.

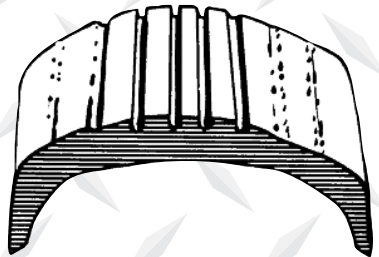

Feathering

Feathering is a condition when the edge of each tread rib develops a slightly rounded edge on one side and a sharp edge on the other. By running your hand over the tire, you can usually feel the sharper edges before you'll be able to see them. The most common cause of feathering is incorrect toe-in setting, which can be cured by having it set correctly.

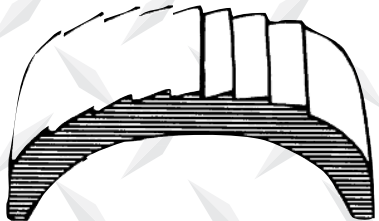

How to Read Tire Wear

One Side Wear

When an inner or outer rib wears faster than the rest of the tire, the need for wheel alignment is indicated. There is excessive camber in the axle, causing the wheel to lean too much to the inside or outside and putting too much load on one side of the tire. The trailer may simply need the wheels aligned, but misalignment could be due to sagging springs, overloaded trailer or an unbalanced load on multi axle trailers.

Because load has a great affect on alignment, be sure the trailer is loaded to balance the weight on the axle or axles. Trailer should be towed level, this is particularly important with independent suspension trailers using torsion axles.

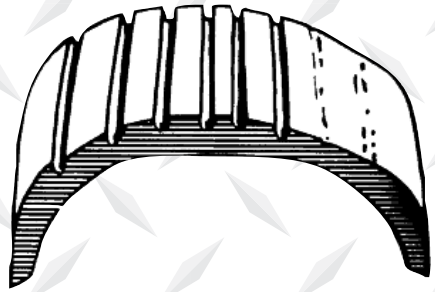

Cupping

Cups or scalloped dips appearing around the edge of the tread on one side or the other, almost always indicate worn (sometimes bent) suspension parts. Adjustment of wheel alignment alone will seldom cure the problem. Any worn component that connects the wheel to the trailer (wheel bearings, springs, bushings, etc.) can cause this condition. Worn components should be adjusted or replaced with new ones. The worn tire should be balanced and possibly moved to a different location on the trailer. Occasionally, wheels that are out of balance will wear like this, but wheel imbalance usually shows up as bald spots between the outside edges and center of the tread.

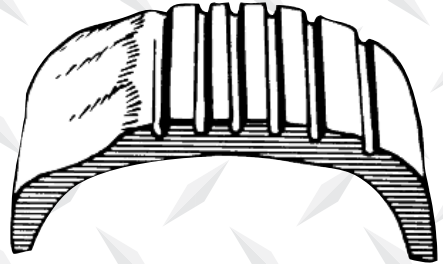

Second Rib Wear

Second-rib wear is normally found only in radial tires, and appears where the steel belts end in relation to the tread. Normally, it can be kept to a minimum by paying careful attention to tire pressure and frequently rotating the tires. Some tire manufacturers consider a slight amount of wear at the second rib of a radial tire normal, but excessive amounts of wear indicate that the tires are too wide for the wheels. Be careful when having oversize tires installed on narrow wheels.

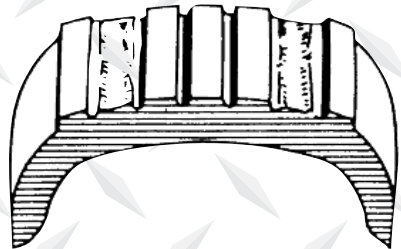

SUPER LUBE "Hub"

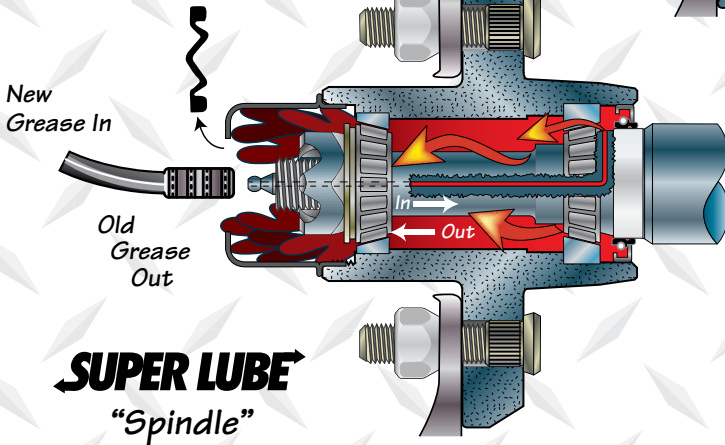
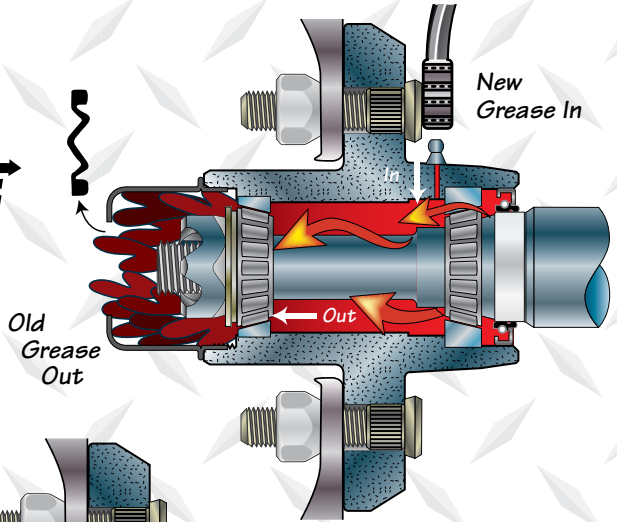

SUPER LUBE "Spindle"

Super Lube Lubrication

1. Remove the rubber plug from the grease (hub) cap.
2. **Super Lube Spindle:** Use a standard grease gun pressed onto the grease fitting located **at the end of the spindle**.
Super Lube Hub: Use a standard grease gun pressed onto the grease fitting located **behind wheel/hub**.
3. Make sure the grease gun nozzle is engaged and fitting tightly. Pump grease into the fitting, while slowly turning the wheel. The old grease will flow out of the hub around the spindle.
4. When the grease appears to be the new clean grease, remove the grease gun and wipe off any excess grease.
5. Replace the rubber plug in the cap.

Standard Hub Maintenance

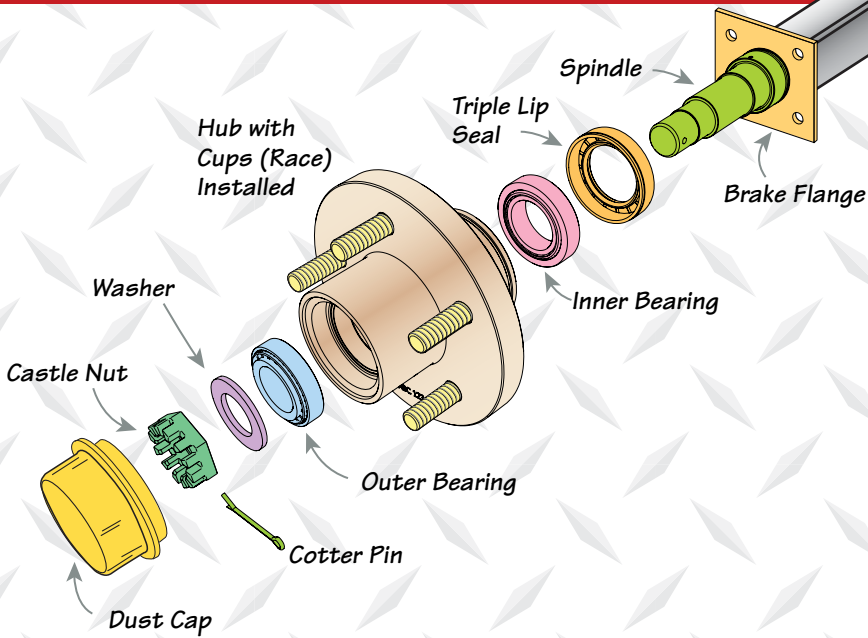

Bearing Lubrication - Non Machine, by Hand

1. Remove wheel from hub.
2. Remove hub dust cap, cotter key, spindle nut and washer.
3. Remove hub from spindle, remove both bearings.
4. Place grease into the palm of your hand.
5. Press widest end of bearing into the outer edge of the grease pile, forcing grease into the inner area of the bearing between two adjacent rollers.
6. Repeat this process while turning bearing from roller to roller until all rollers are coated.
7. Fill wheel hub with grease to inside diameter of outer cups and also fill hub grease cap.
8. Reassemble bearings into same size cups.
9. Mount wheel.
10. Tighten the spindle nut with a 1/2 inch wrench to approximately 40 ft. lbs. Turn wheel in both directions to be sure wheel turns freely.
11. Turn back spindle nut 1/6 to 1/4 turn to the nearest locking hole. Wheel should turn smoothly with no end play or wobble.
12. Line up cotter key with nearest locking hole and spread key.
13. Install dust cap.

Never use grease heavier than 265 A.S.T.M. penetration (No. 2 grade).
It is not recommended that a pressure grease fitting be installed on the hub.

Tie Down Engineering (Tie Down) provides to the original purchaser only a limited warranty on each Tie Down axle assembly against defects in material or workmanship for a period of one (1) year from date of purchase. THE FOREGOING WARRANTY IS EXCLUSIVE AND IN LIEU OF ALL OTHER WARRANTIES EXCEPT THAT OF TITLE, WHETHER WRITTEN, ORAL OR IMPLIED, IN FACTOR IN LAW (INCLUDING ANY WARRANTY OF MERCHANTABILITY OR FITNESS FOR A PARTICULAR PURPOSE.)

Note: When submitting warranty claims on an axle or on parts assembled to the axle (brakes, hubs, springs, etc.) Submit a claim for the part in question not the entire axle assembly.

1. This warranty does not extend to:
 - A. The connecting of brake wiring to the trailer wiring or trailer wiring to the towing vehicle wiring
 - B. The attachment of the running gear to the frame
 - C. Hub imbalance, or any damage caused thereby
 - D. Parts not supplied by the Tie Down
 - E. Any damage whatever if caused by or related to any alteration of the axle
 - F. Use of axle assembly on unit other than that to which it was originally mounted
 - G. Normal wear
 - H. Tow and camber alignment issues
 - I. Tire Wear
 - J. Modified axles, including additional holes or enlarging of existing holes in axle beams mounting brackets
2. This warranty does not cover defects caused by:
 - A. Improper installation
 - B. Damage (not resulting from defect or malfunction) while in the possession of the customer
 - C. Unreasonable use (including failure to provide reasonable and necessary maintenance)
 - D. Improper wheel nut torque
 - E. Customer welds on the axle beam mounting brackets
3. The exclusive remedy offered under this warranty is repair or replacement of a covered defect and Tie Down shall determine whether repair or replacement is appropriate. Tie Down shall not be liable for any incidental or consequential damages, including any towing fees, hotel bills, telephone calls and meals for breach of any express or implied warranty on the running gear.
4. Some states do not allow the exclusion or limitation of incidental or consequential damages, so the above limitation or exclusion may not apply to you. This warranty gives you specific legal rights and you may also have other rights which vary from state to state.

To obtain warranty service, please contact:

warrantymanager@tiedown.com or Call 404-344-0000 Ext. 1538.



Spring Axle Owner's Manual



TIE DOWN ENGINEERING

255 Villanova Drive SW • Atlanta, Georgia 30336
800-241-1806 • 404-344-0000 • Fax 404-349-0401
ISO 9001:2008 Certification

Trade, brand, names and drawings are the intellectual
property of TIE DOWN ENGINEERING.

©2015 TIE DOWN, Inc.

Manual #08260 (Rev. 10/27/2015, C1143)