

### Tools Required

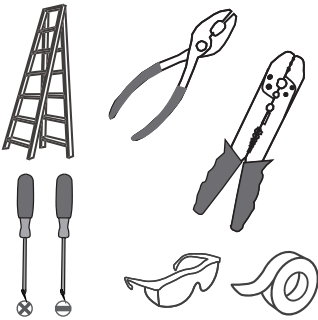

### Light Source

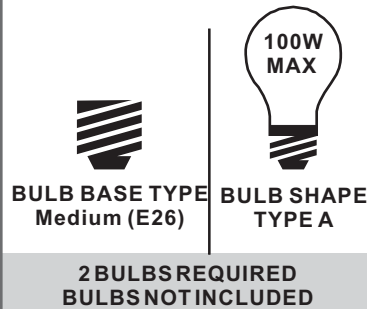

### Warnings and Cautions

Turn off the electricity at the circuit breaker before installation. Consult a licensed electrician if in doubt about installation.

Turn off power to the fixture and allow the bulbs to cool before replacing.

### Package Contents

**Preparation:** Identify and inspect all parts before beginning the installation.

Missing or damaged parts? Contact your original place of purchase.

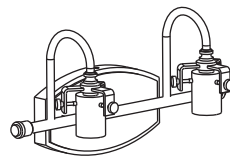

E Fixture Body  
x 1

#### PARTS BAG

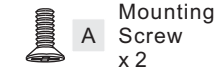

A Mounting Screw  
x 2



B Outlet Box Screw  
x 2



C Wire Connector  
x 3



D Inner Backplate  
x 1



F Shade  
x 2

### Table of Contents

#### Inner Backplate



STEP 1

#### Wiring

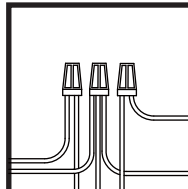

STEP 2

#### Fixture Body

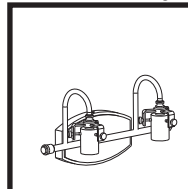

STEP 3

#### Shade & Bulb

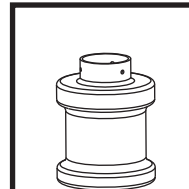

STEP 4

### STEP 1

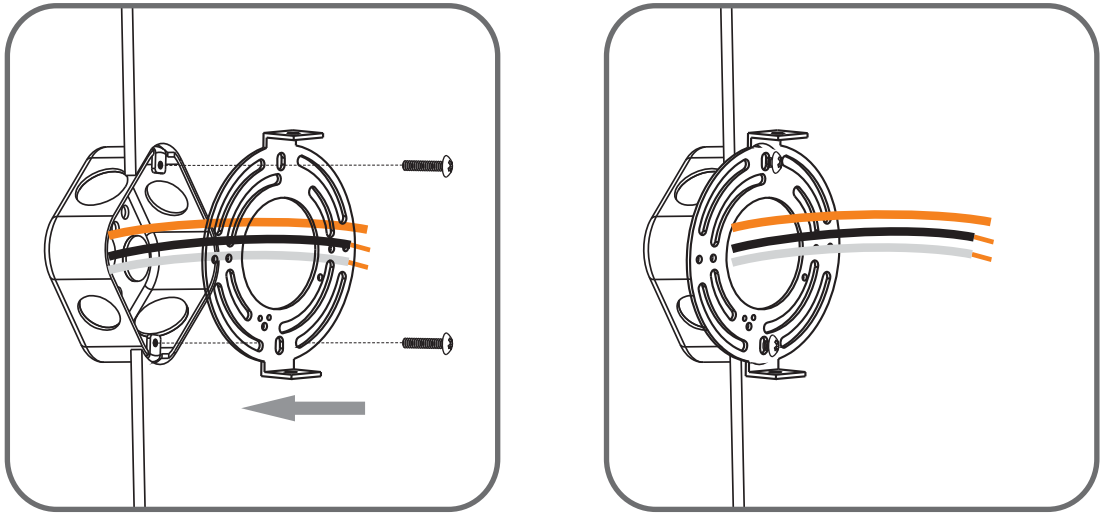

### STEP 2

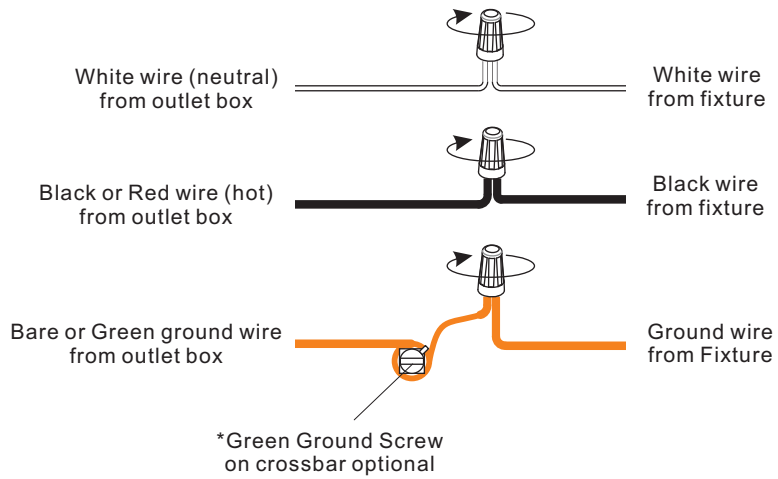

### STEP 3

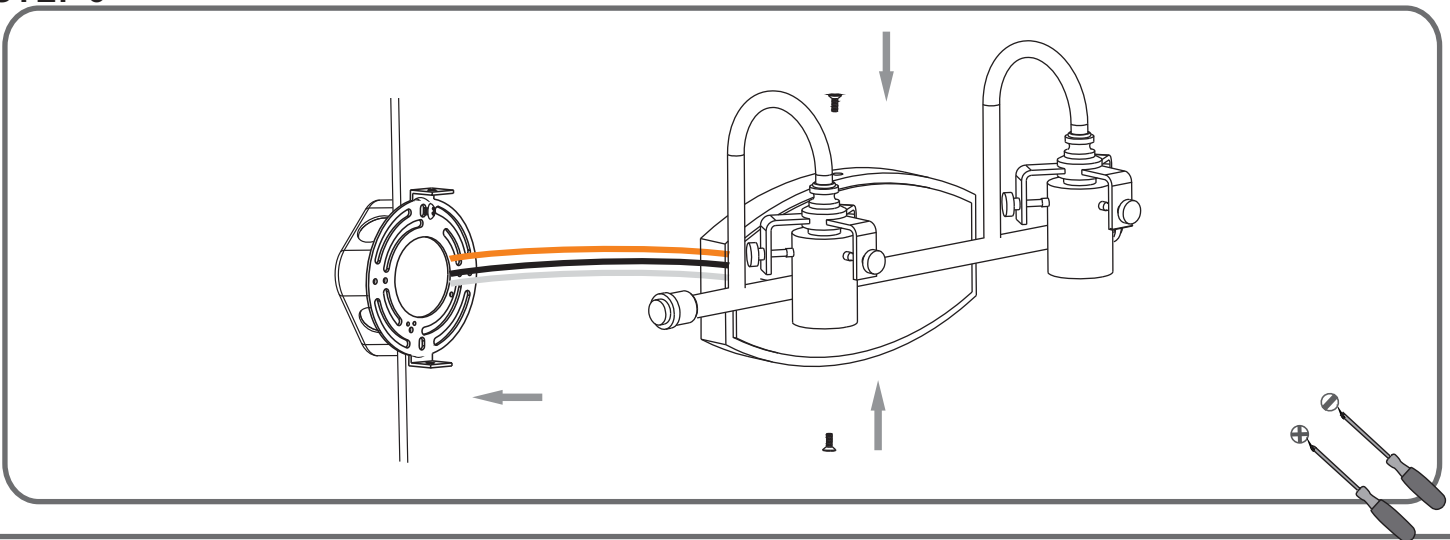

STEP 4

1

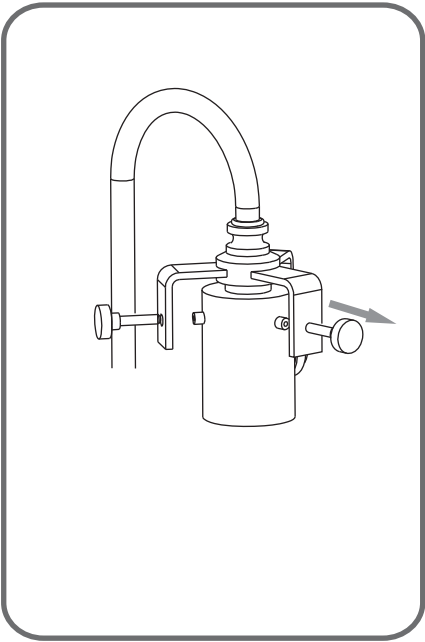

2

