

Tools Required

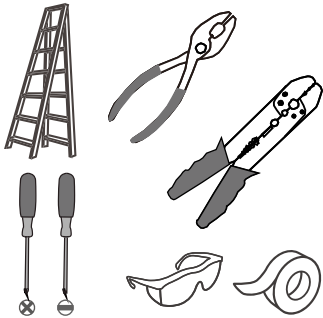

Light Source

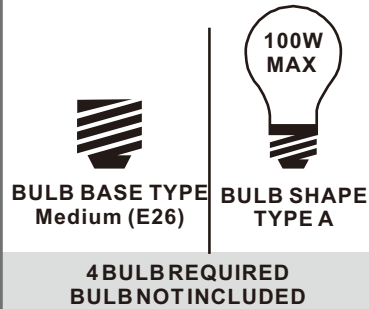

Warnings and Cautions

Turn off the electricity at the circuit breaker before installation. Consult a licensed electrician if in doubt about installation.

Turn off power to the fixture and allow the bulbs to cool before replacing.

Package Contents

Preparation: Identify and inspect all parts before beginning the installation.

Missing or damaged parts? Contact your original place of purchase.

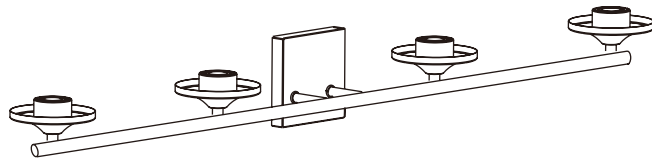

E Fixture Body x 1

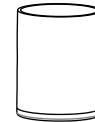

F Shade x 4

PARTS BAG

A Mounting Screw x 2

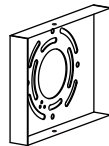

B Inner Backplate x 1

C Outlet Box Screw x 2



D Wire Connector x 3

Table of Contents

Inner Backplate	Wiring	Fixture Body	Shade & Bulb
STEP 1	STEP 2	STEP 3	STEP 4

STEP 1

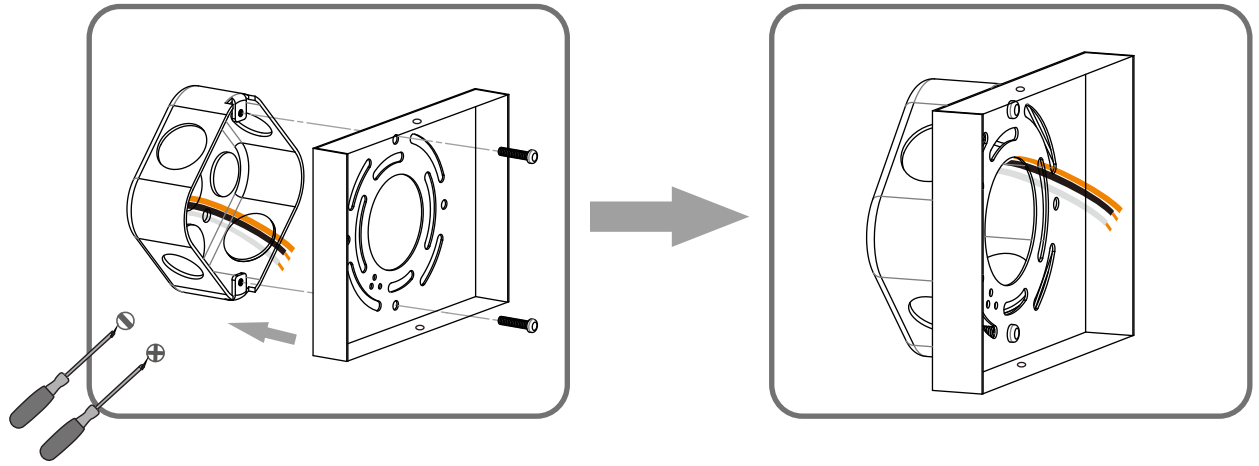

STEP 2

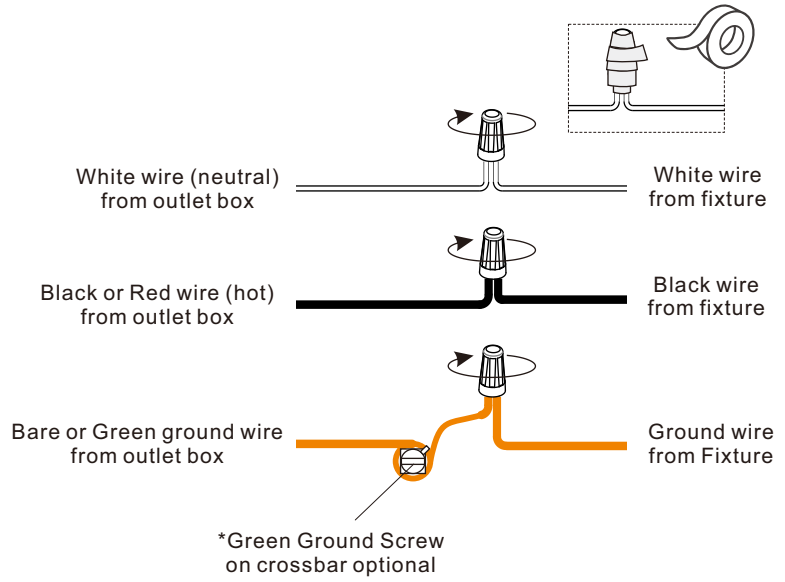

STEP 3

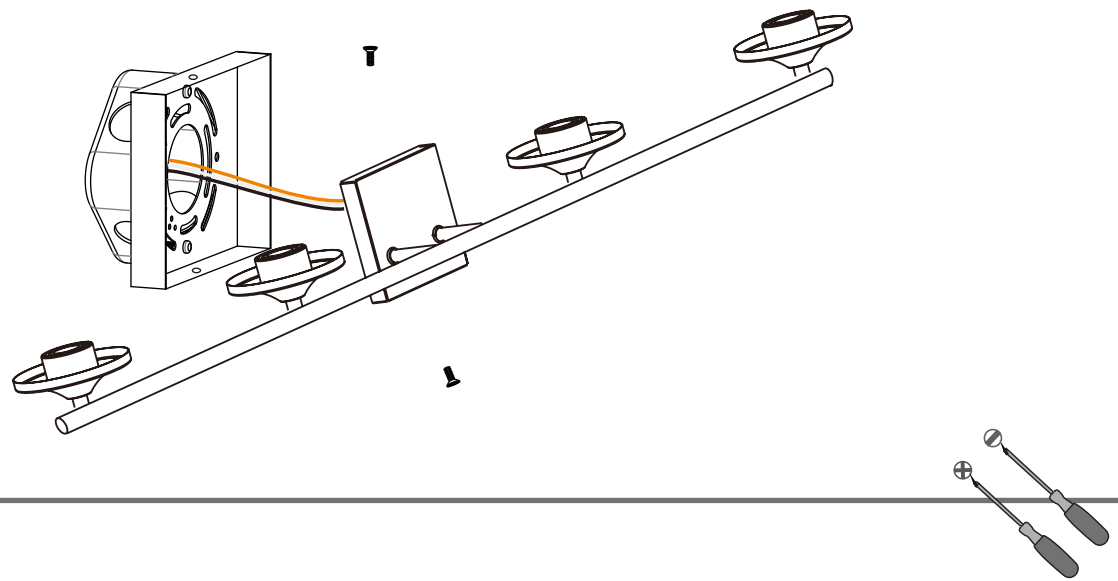

STEP 4

