

### Tools Required

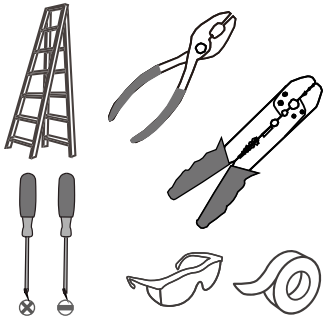

### Light Source

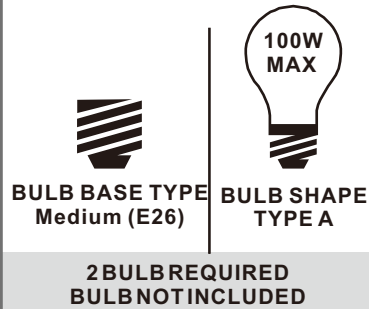

### Warnings and Cautions

Turn off the electricity at the circuit breaker before installation. Consult a licensed electrician if in doubt about installation.

Turn off power to the fixture and allow the bulbs to cool before replacing.

### Package Contents

**Preparation:** Identify and inspect all parts before beginning the installation.

Missing or damaged parts? Contact your original place of purchase.

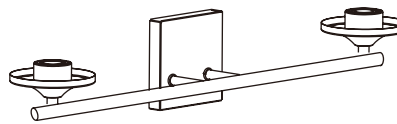

E Fixture Body x 1

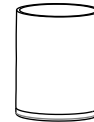

F Shade x 2

#### PARTS BAG



A Mounting Screw x 2

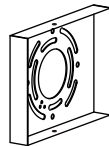

B Inner Backplate x 1



C Outlet Box Screw x 2



D Wire Connector x 3

### Table of Contents

Inner Backplate	Wiring	Fixture Body	Shade & Bulb
STEP 1	STEP 2	STEP 3	STEP 4

**STEP 1**

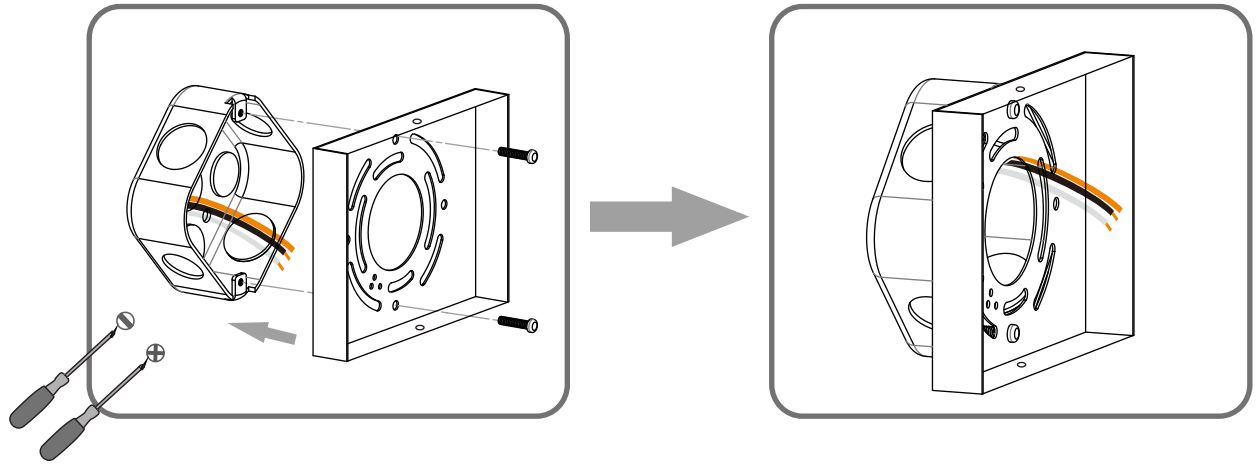

**STEP 2**

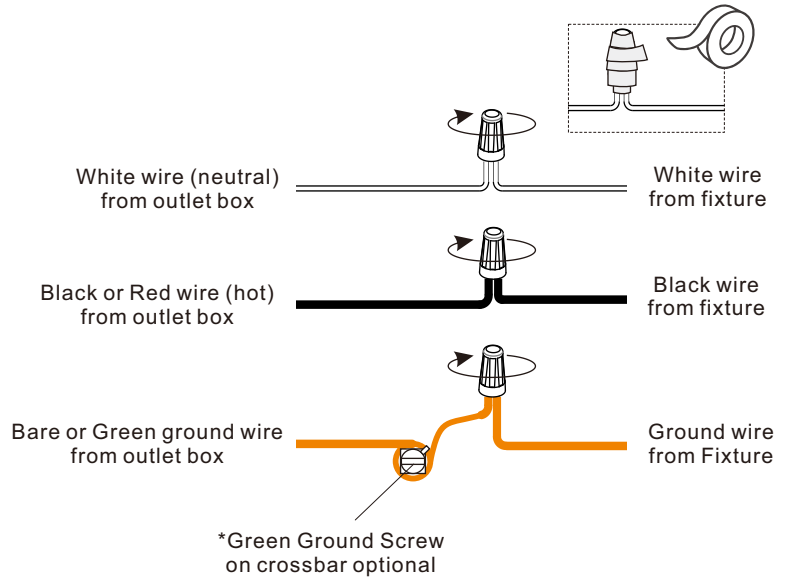

**STEP 3**

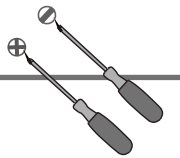
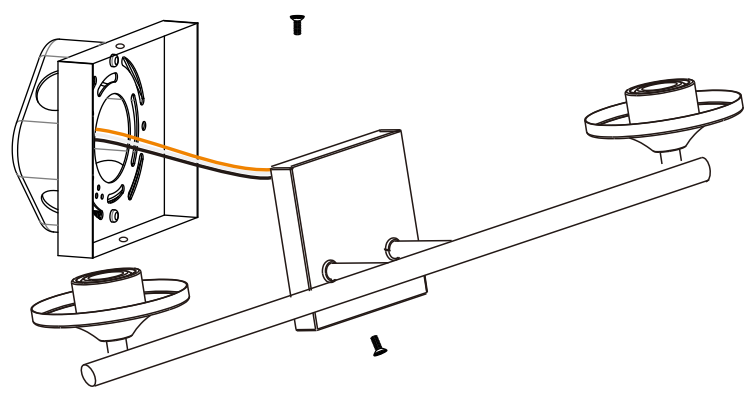

**STEP 4**

