

Tools Required

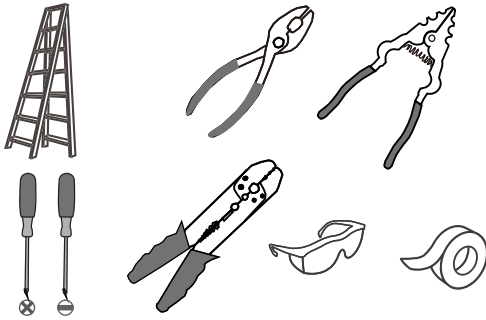

Light Source

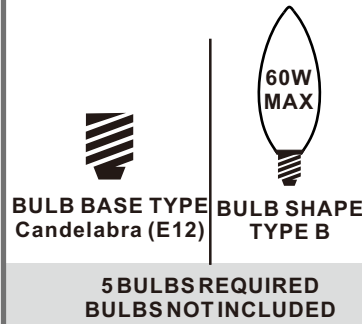

Fixture Height Adjustable 25.75" to 73.75"

⚠ Warnings and Cautions

Turn off the electricity at the circuit breaker before installation. Consult a licensed electrician if in doubt about installation.

Turn off power to the fixture and allow the bulbs to cool before replacing.

Package Contents

Preparation: Identify and inspect all parts before beginning the installation.

Missing or damaged parts? Contact your original place of purchase.

PARTS BAG

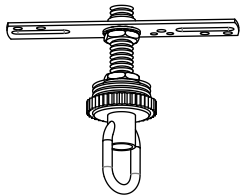

A Crossbar Assembly
x 1



B Outlet Box Screw
x 2

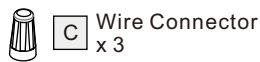

C Wire Connector
x 3



D Quick Link
x 2

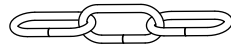

E Fixture Chain
x 1

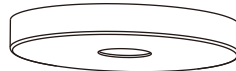

F Ceiling Canopy
x 1



G Fixture Loop
x 1



I Cap
x 1



K Rod
x 1



J Finial
x 1

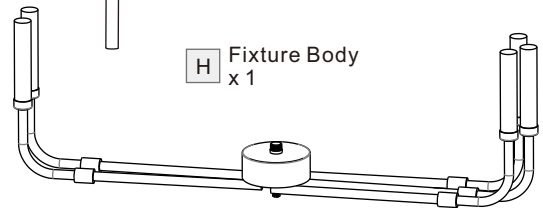

H Fixture Body
x 1

Table of Contents

Fixture Loop	Crossbar Assembly	Fixture Chain	Wiring	Ceiling Canopy	Bulb
STEP 1	STEP 2	STEP 3	STEP 4	STEP 5	STEP 6

STEP 1

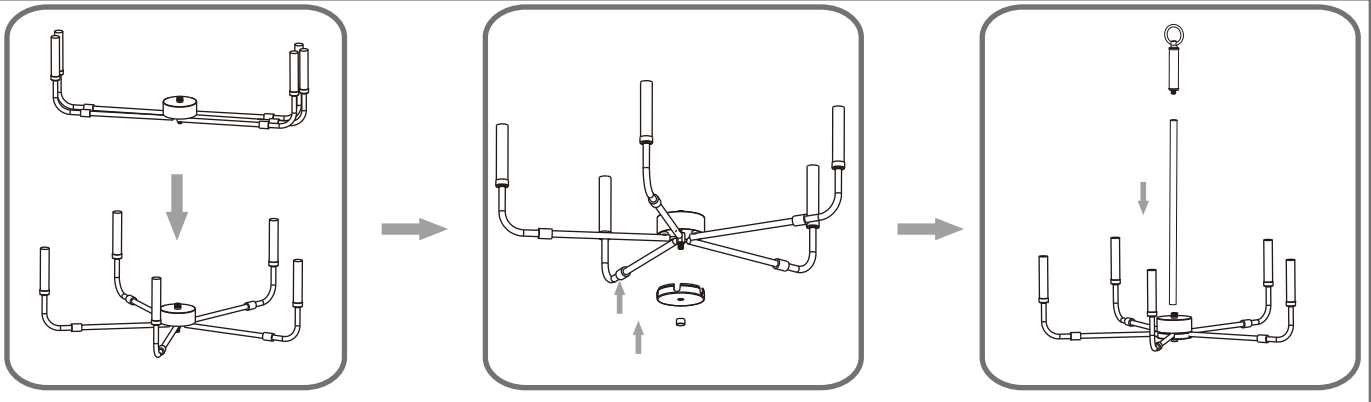

STEP 2

1

Step 1
Install crossbar assembly

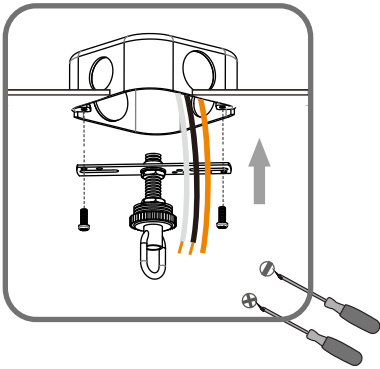

2

Step 2 - 3
Test fitting ceiling canopy to nipple

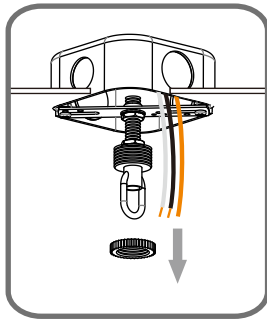

3

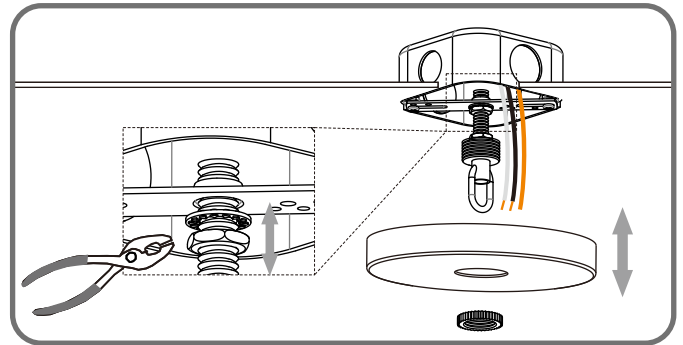

STEP 3

1

Step 1
Adjust fixture chain length

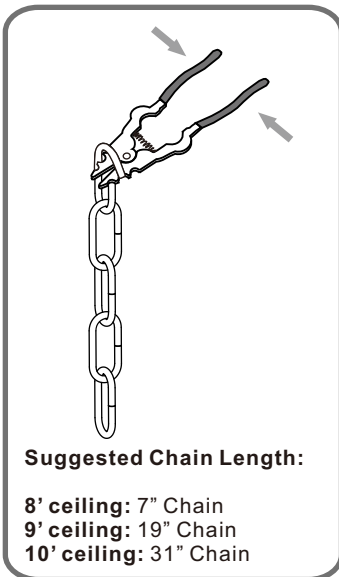

2

Step 2 - 3
Install Fixture Chain

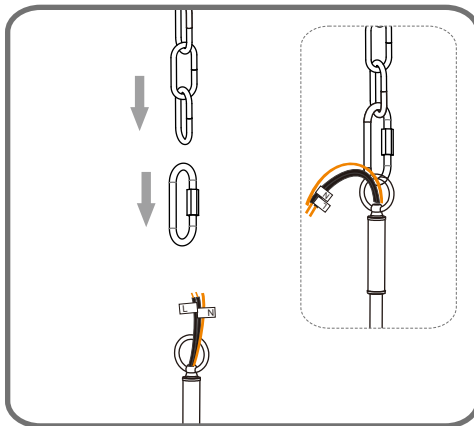

3

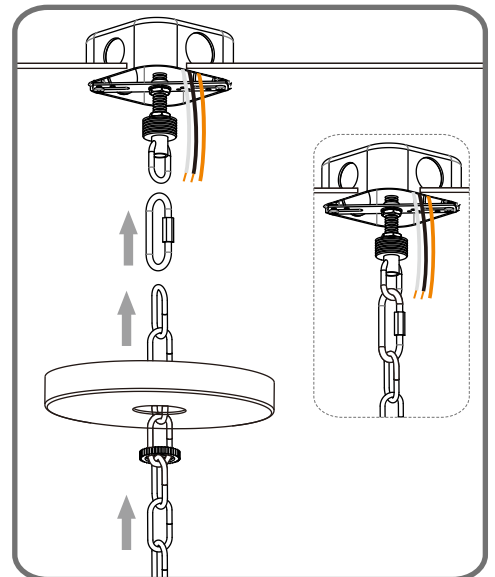

STEP 4

1

Step 1
Feed the fixture wires
through the loop

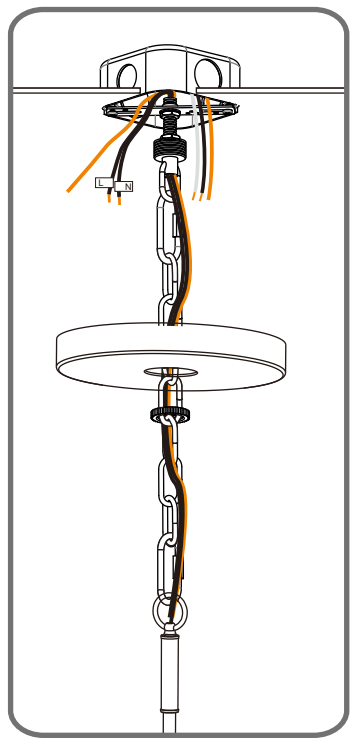

2

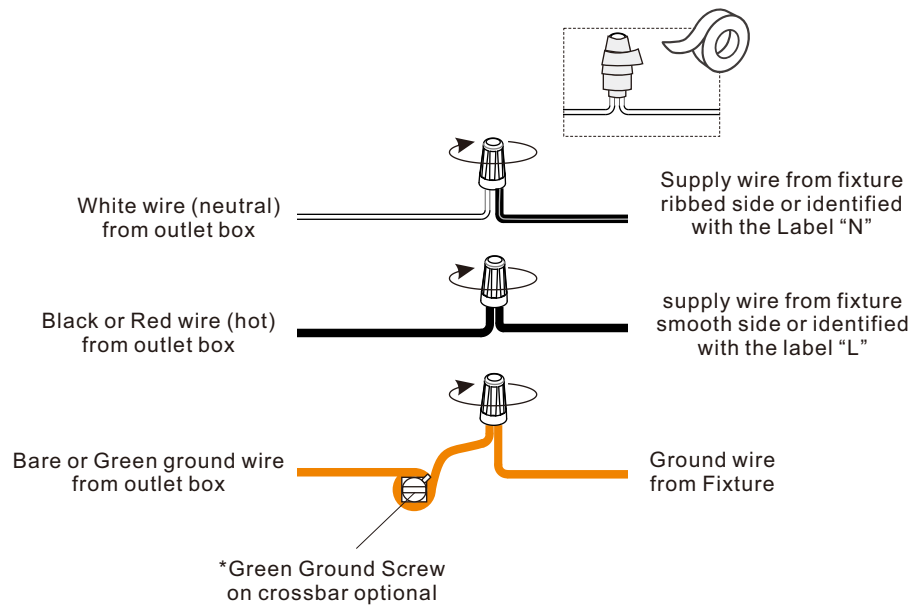

STEP 5

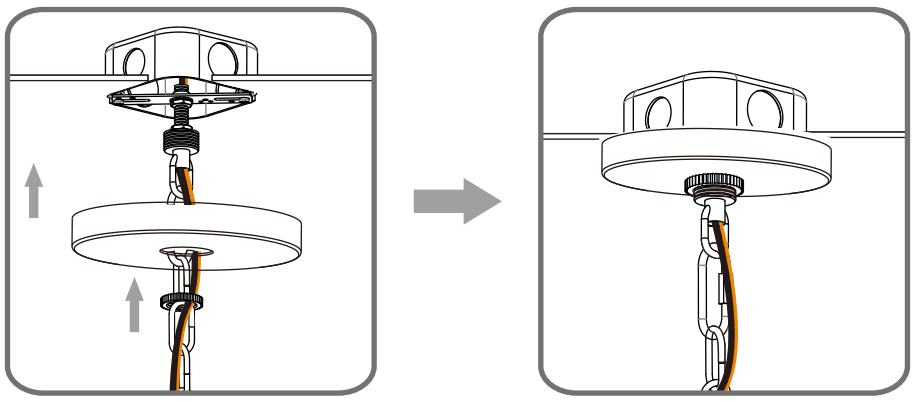

STEP 6

