

### Tools Required

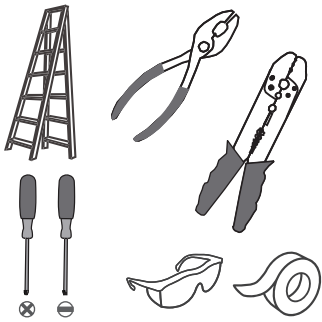

### Light Source

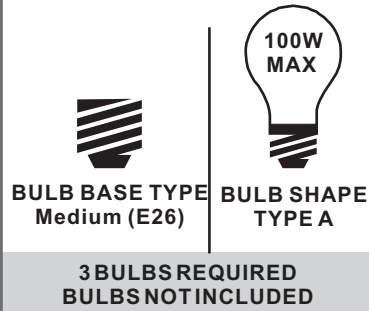

### ⚠ Warnings and Cautions

Turn off the electricity at the circuit breaker before installation. Consult a licensed electrician if in doubt about installation.

Turn off power to the fixture and allow the bulbs to cool before replacing.

### Package Contents

**Preparation:** Identify and inspect all parts before beginning the installation.

Missing or damaged parts? Contact your original place of purchase.

**Note:** Shade shape is for illustration purpose only. Your shade shape may vary from illustration.

#### PARTS BAG

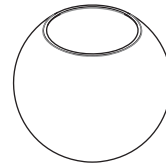
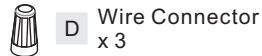
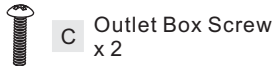
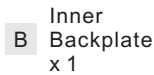
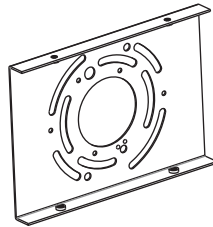
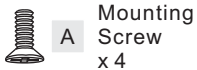

E Shade (Varies according to style purchased) x 3

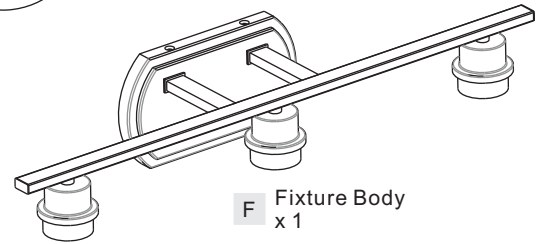

F Fixture Body x 1

### Table of Contents

#### Inner Backplate

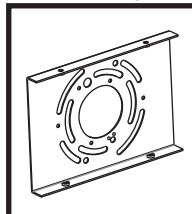

STEP 1

#### Wiring

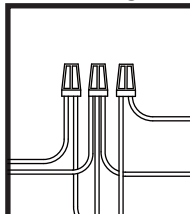

STEP 2

#### Fixture Body

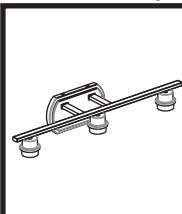

STEP 3

#### Shade & Bulb

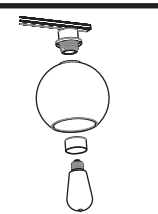

STEP 4

**STEP 1**

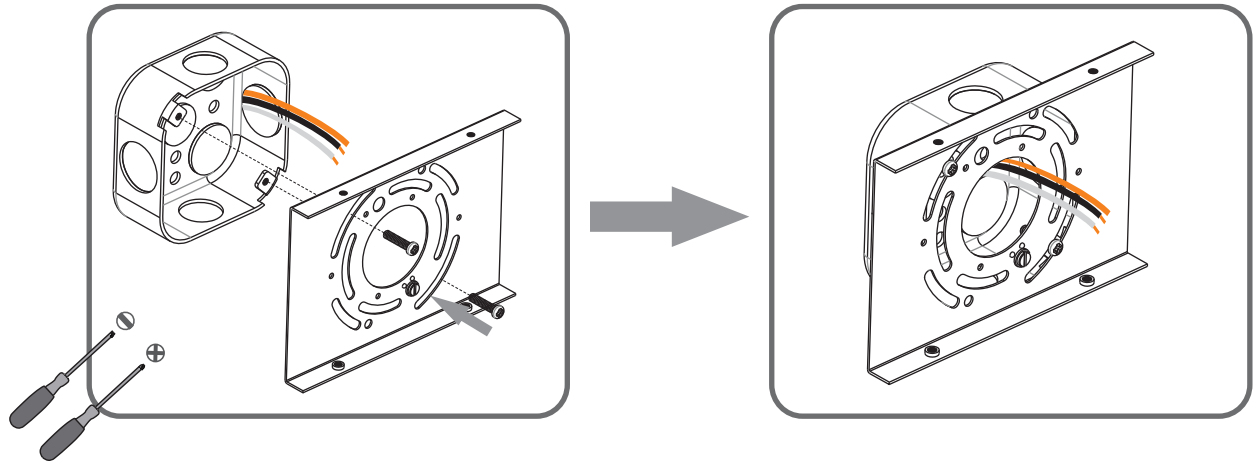

**STEP 2**

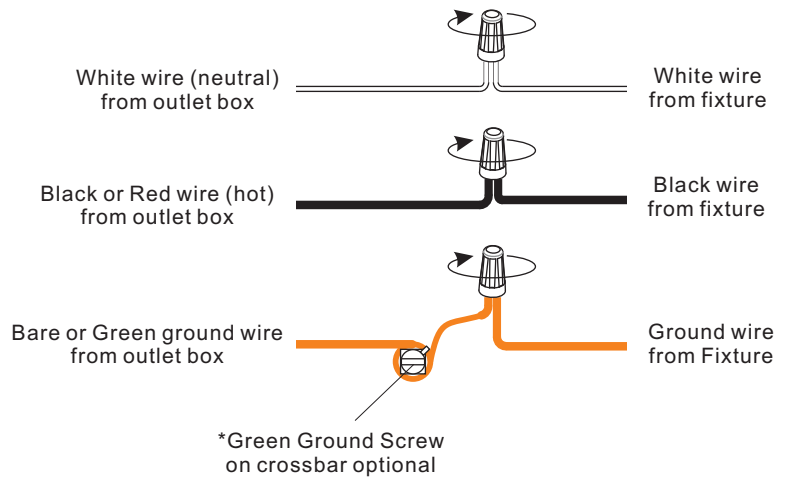

**STEP 3**

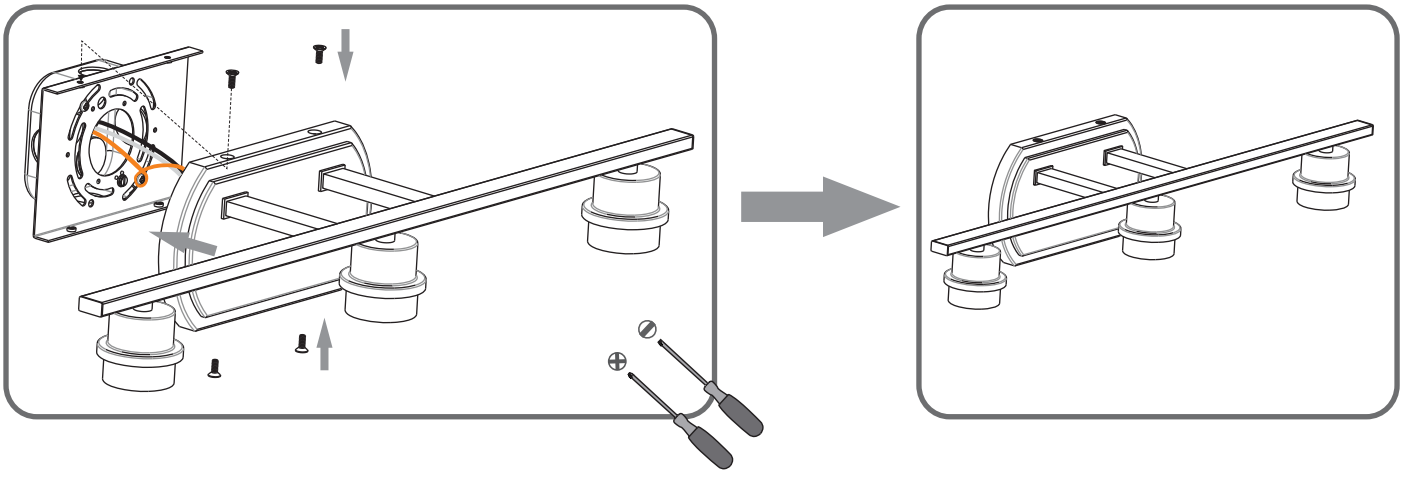

**STEP 4**

**1**

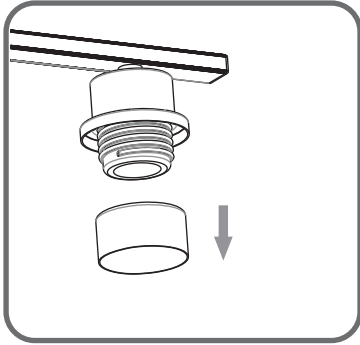

**2**

**Note: Shade shape is for illustration purpose only. Your shade shape may vary from illustration.**

