

Tools Required

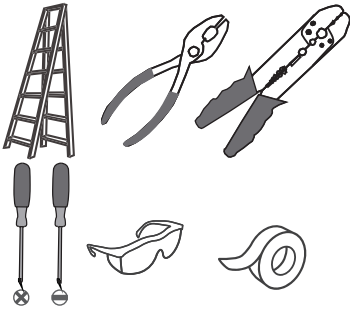

Light Source



2 GU10 MR16 LED 5W
BULBS INCLUDED



BULB BASE TYPE
Medium (E26)



BULB SHAPE
TYPE A

6 BULBS REQUIRED
BULBS NOT INCLUDED

Fixture Height Adjustable 22" to 46"

⚠ Warnings and Cautions

Turn off the electricity at the circuit breaker before installation. Consult a licensed electrician if in doubt about installation.

Turn off power to the fixture and allow the bulbs to cool before replacing.

Package Contents

Preparation: Identify and inspect all parts before beginning the installation.

Missing or damaged parts? Contact your original place of purchase.

PARTS BAG

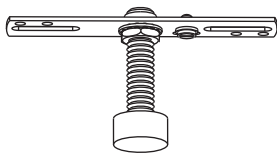

A Crossbar Assembly
x 1



B Outlet Box Screw
x 2

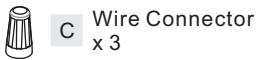

C Wire Connector
x 3



D Quick Link
x 2

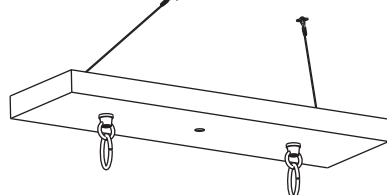

E Ceiling Canopy
x 1

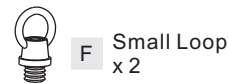

F Small Loop
x 2

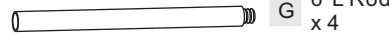

G 6" L Rod
x 4

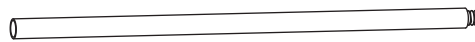

H 12" L Rod
x 4

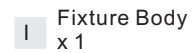

I Fixture Body
x 1

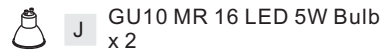
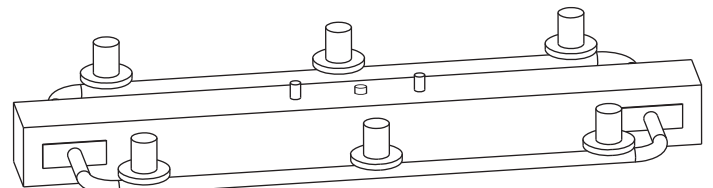

J GU10 MR 16 LED 5W Bulb
x 2

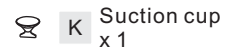

K Suction cup
x 1

Table of Contents

Rods & Small Loop

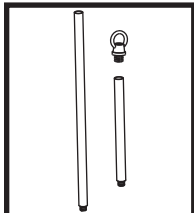

STEP 1

Crossbar Assembly

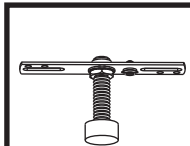

STEP 2

Quick Link



STEP 3

Lanyard

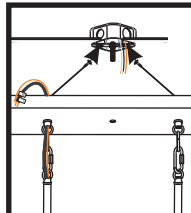

STEP 4

Wiring

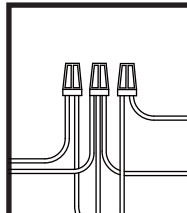

STEP 5

Ceiling Canopy

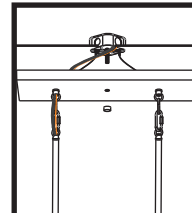

STEP 6

Bulb



STEP 7

STEP 1

Optional Rods

- 8' ceiling:
(4) 6"L + (2) 12"L rods
- 9' ceiling:
(4) 6"L + (4) 12"L rods

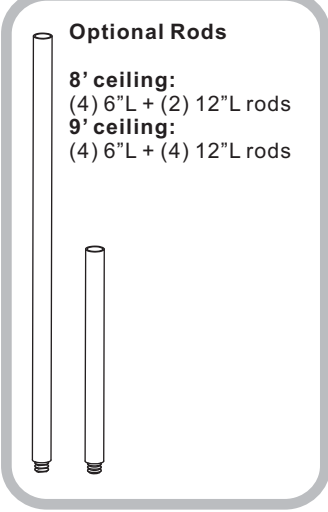

1 ----- 2

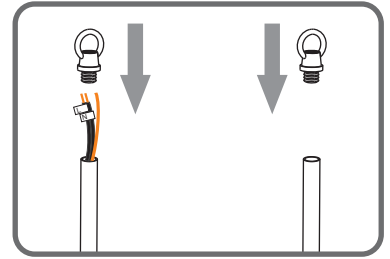
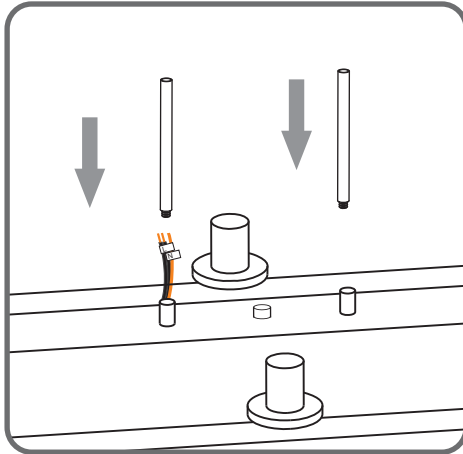

STEP 2

1 ----- 2 ----- 3

Step 1 Install crossbar assembly

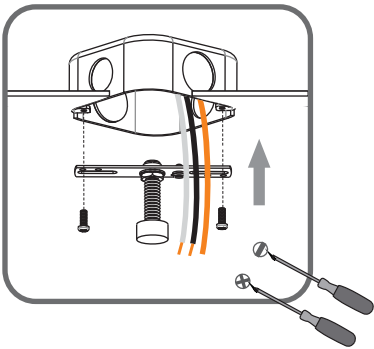

Step 2 - 3 Test fitting ceiling canopy to nipple

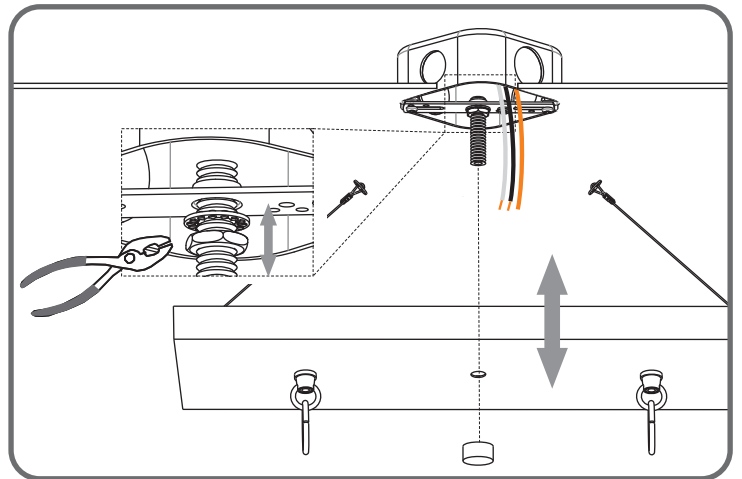
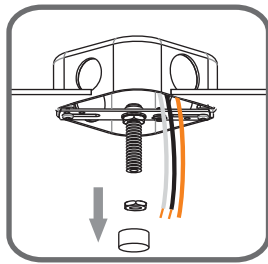

STEP 3

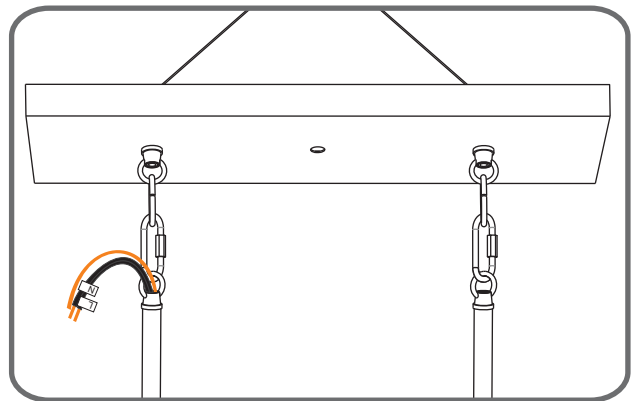
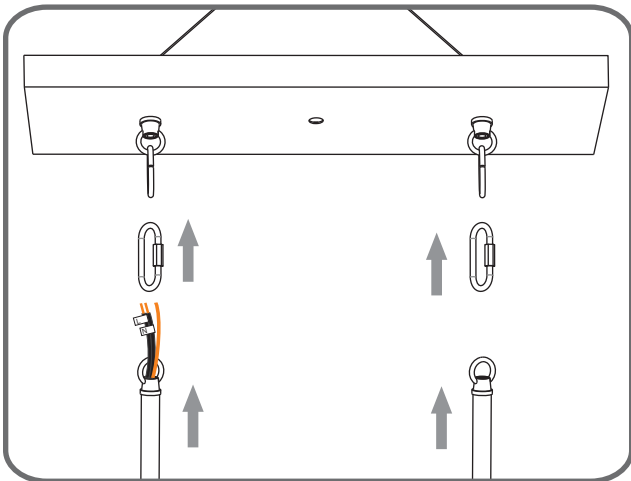

STEP 4

1

Step 1
Feed the fixture wires
through the ceiling canopy

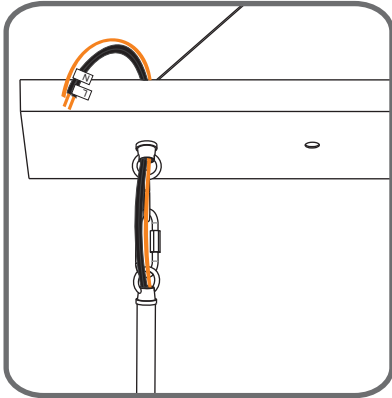

2

Step 2
Install Lanyard

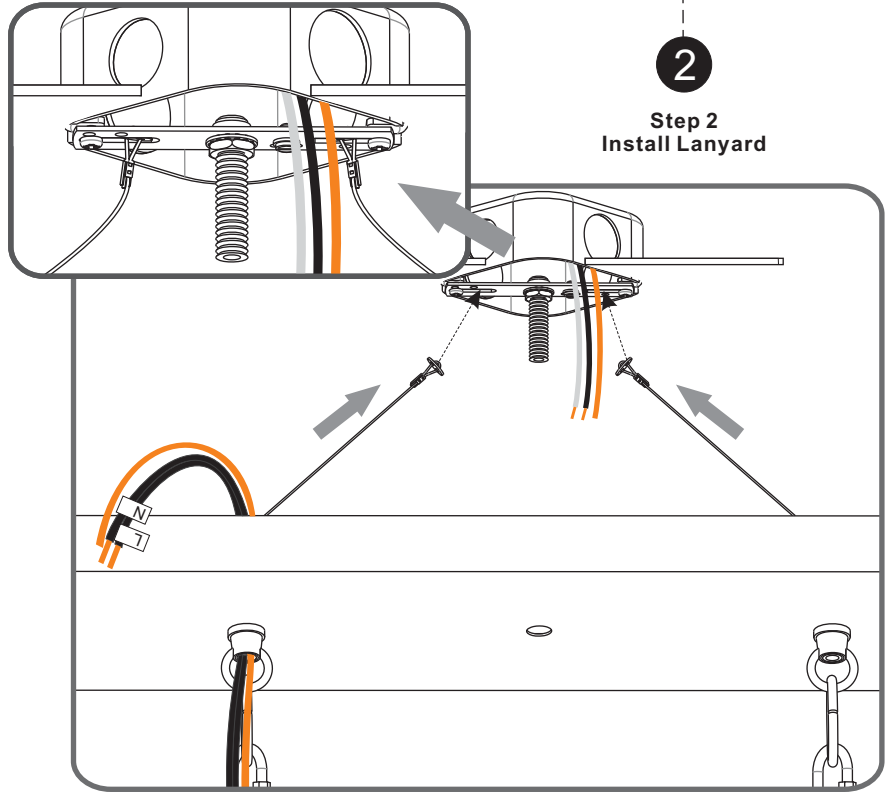

STEP 5

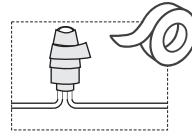

White wire (neutral)
from outlet box

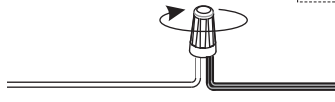

Supply wire from fixture
Ribbed side or identified
with the Label "N"

Black or Red wire (hot)
from outlet box

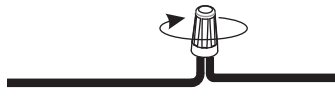

supply wire from fixture
Smooth side or identified
with the label "L"

Bare or Green ground wire
from outlet box

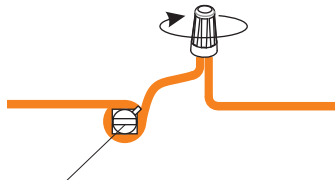

Ground wire
from Fixture

*Green Ground Screw
on crossbar optional

STEP 6

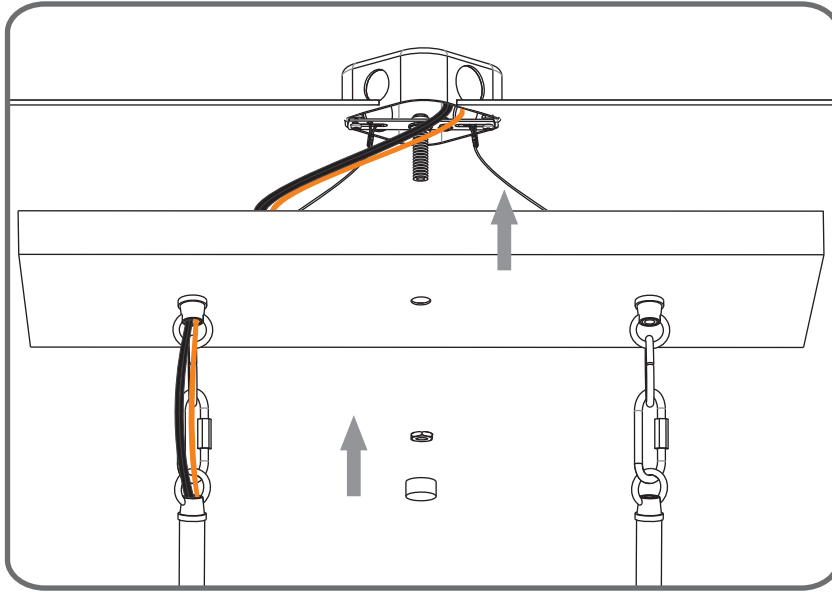

STEP 7

