

Tools Required: Flathead screwdriver, Phillips screwdriver, pliers, wire cutters, wire strippers, electrical tape, safety glasses.

Light Source: (1) A19 Medium Base Bulb 100W Maximum or
(1) Medium Base Vintage Bulb is recommended but not supplied.

Estimated Assembly Time: 30-45 minutes

Preparation: Identify and inspect all parts before beginning installation. Check package content list and diagrams below to be sure all parts are present. If any parts are missing or damaged, do not attempt to assemble, install, or operate the fixture. Contact customer service for replacement parts.

⚠ Warnings and Cautions

Turn off electricity at circuit breaker or main fuse box before installation. Consult a licensed electrician if in doubt.

These instructions are provided for your safety. It is very important you read them completely before installing the fixture. We strongly recommend that a licensed, professional electrician perform the installation.

Disconnect fixture from power source before replacing bulbs. Make sure bulbs are given sufficient time to cool before removal.

Package Contents

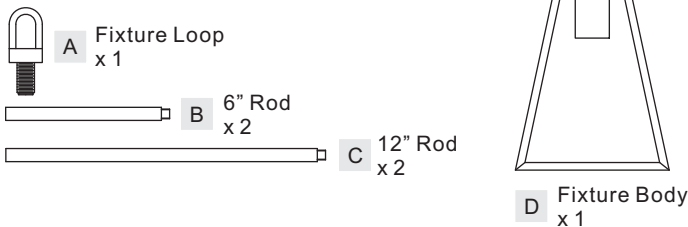

Hardware Contents

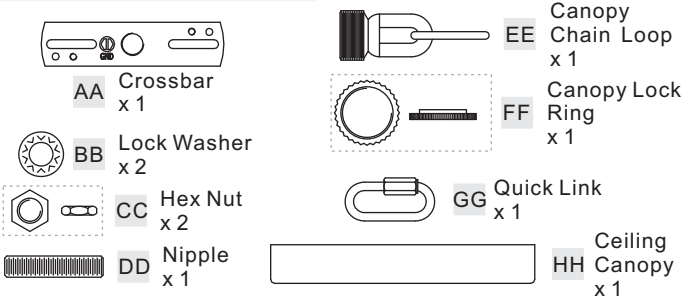

STEP 1 – Install Fixture Loop and Rods to Fixture Body

- Determine the Rods (B/C) to be assembled to the Fixture Body (D) according to your hanging height.
- Pass the supply wires and ground wire through the chosen rods (B/C) and the Fixture Loop (A). Thread the Fixture Body (D), the chosen Rods (B/C) and the Fixture Loop (A) together. Hand tighten until snug.

Suggested rods for Ceiling height:

- 8' ceiling : use (1) 6" rod and (1) 12" rod
- 9' ceiling : use (1) 6" rod and (2) 12" rods
- 10' ceiling : use (2) 6" rods and (2) 12" rods

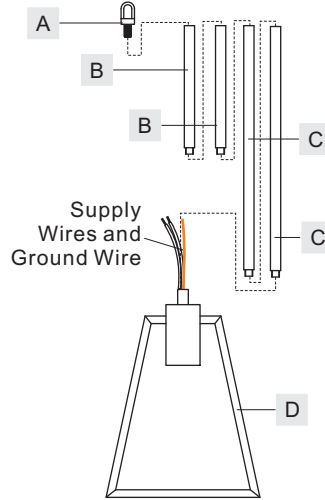

Figure 1

STEP 2 – Install the Crossbar to the junction box

- Attach the Crossbar (AA) to the Outlet Box with the head of the Green Ground Screw facing you. Secure it with Outlet Box Screws (not included), tighten until snug.

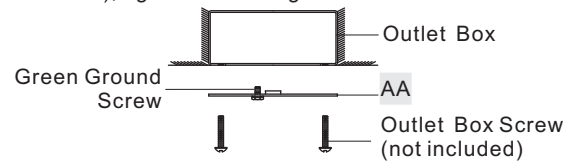

Figure 2

STEP 3 – Install the Canopy Chain Loop and Nipple

- Thread one Hex Nut (CC) to one end of the Nipple (DD) until it is at least 0.25" from the end. Pass one Lock Washer (BB) over the end of the Nipple (DD) and thread the Canopy Chain Loop (EE) onto the Nipple (DD). By using pliers, thread the Hex Nut (CC) against the Canopy Chain Loop (EE) and hand tighten until snug.
- Thread another Hex Nut (CC) to the middle of the Nipple (DD). Place another Lock Washer (BB) over the Nipple (DD) and then thread the Nipple (DD) into the Crossbar (AA) until the Nipple (DD) is about 0.375" above the Crossbar (AA).
- Remove the Canopy Lock Ring (FF) from the Canopy Chain Loop (EE). Place the Ceiling Canopy (HH) over the Canopy Chain Loop (EE) against the ceiling to determine the correct position of the Nipple (DD). Thread the Canopy Lock Ring (FF) onto the Canopy Chain Loop (EE). Adjust the Nipple (DD) to allow the Ceiling Canopy (HH) to rest against the ceiling when held in place by the Canopy Lock Ring (FF).
- Remove the Canopy Lock Ring (FF) and the Ceiling Canopy (HH). Tighten the Hex Nut (CC) against the Crossbar (AA) to secure in place.

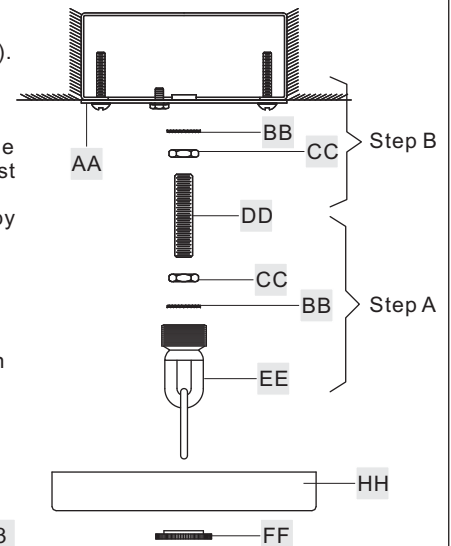

Figure 3

STEP 4 - Install the Fixture Chain and Ceiling Canopy

- A. Pull the supply wires and ground wire through the Canopy Lock Ring (FF) and the Ceiling Canopy (HH) in order.
- B. Connect the Fixture Loop (A) to the Canopy Chain Loop (EE) by using the Quick Link (GG). The fixture will now hang safely.
- C. Feed the Supply Wires and Ground Wire through the Canopy Chain Loop (EE) and Nipple (DD) into the Outlet Box. Cut the wires leaving approximately 8" of wire extending from the Outlet Box.
- D. Go to Step 5 for wire connections and follow the directions. Return to Step E in this step when complete with Step 5.
- E. Raise the Ceiling Canopy (HH) and Canopy Lock Ring (FF) up the Quick Link (GG) and over the Canopy Chain Loop (EE). Tighten the Canopy Lock Ring (FF) onto the Canopy Chain Loop (EE) until tight.

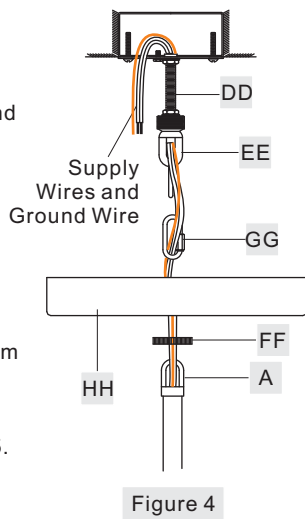
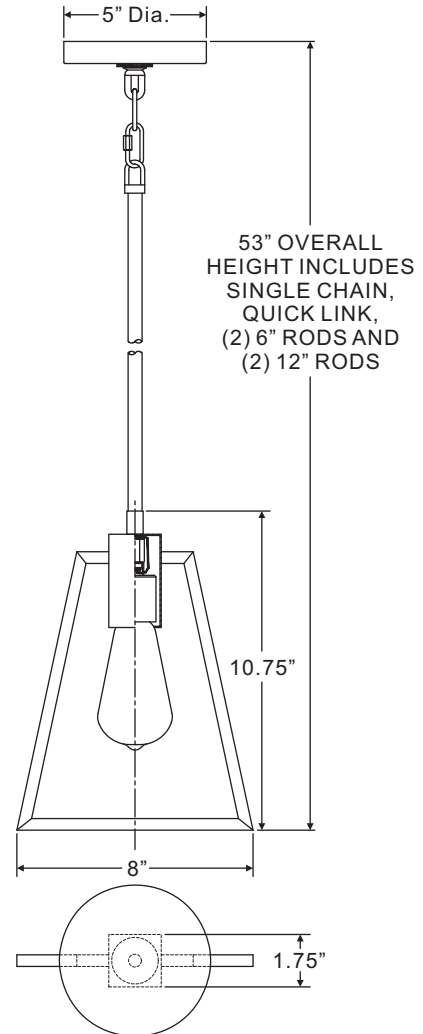
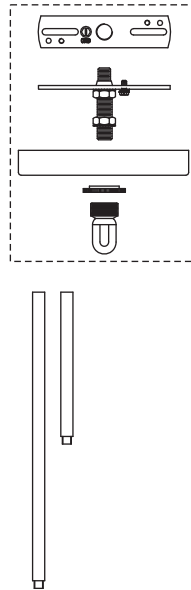

Figure 4

UQL2812



53" OVERALL HEIGHT INCLUDES SINGLE CHAIN, QUICK LINK, (2) 6" RODS AND (2) 12" RODS

NOTE: ALL DIMENSIONS ARE ROUNDED UP TO THE NEAREST 1/4"

STEP 5 - Making the Wire Connections

- A. Wrap bare or green ground wire around green ground screw on the crossbar, no less than 2 inches from the end of the wire. Tighten the green ground screw.
- B. Use standard wire connectors (not included) to make all wire connections. Twist connectors until wires are tightly joined together. Wrap each connection with approved electrical tape and carefully stuff all the connected wires into outlet box.

Note: If the electrical wire is going to be cut shorter than provided you will need to identify the "L" line wire and the "N" neutral wire before you cut the excess wire off. One is labeled N and the other labeled L. To do this separate the "L" line wire and the "N" neutral wire as far as you need to. Re-label the wire near where you want to make the cut. Be sure to mark the wire on the side of the fixture and not on the excess wire being cut and removed.

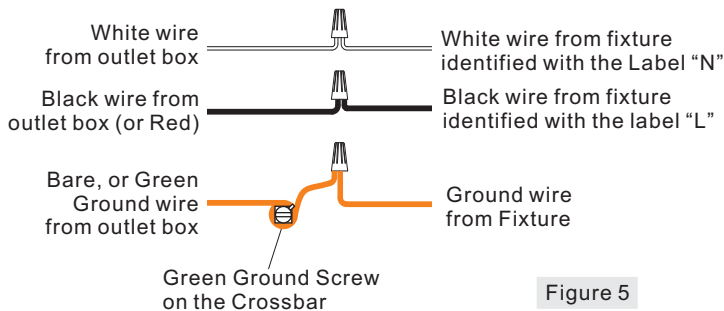

Figure 5

STEP 6 - Install the Bulb

- A. Insert the bulb onto socket and screw snugly into place.

Your fixture is now assembled and ready to use. Enjoy!

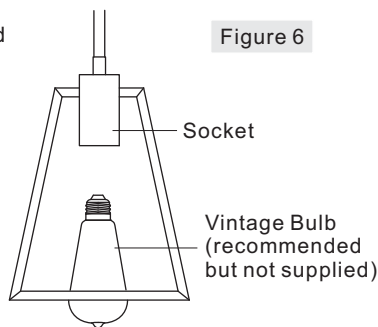

Figure 6