

Tools Required: Flathead screwdriver, Phillips screwdriver, pliers, wire cutters, wire strippers, electrical tape, safety glasses.

Light Source: (6) Candelabra Base Bulbs 60W Maximum

Estimated Assembly Time: 30-45 minutes

Preparation: Identify and inspect all parts before beginning installation. Check package content list and diagrams below to be sure all parts are present. If any parts are missing or damaged, do not attempt to assemble, install, or operate the fixture. Contact customer service for replacement parts.

Note: This CONVERTIBLE fixture can be mounted as pendant light or semi-flush light. Refer to respective installation steps for installations.

⚠ Warnings and Cautions

Turn off electricity at circuit breaker or main fuse box before installation. Consult a licensed electrician if in doubt.

These instructions are provided for your safety. It is very important you read them completely before installing the fixture. We strongly recommend that a licensed, professional electrician perform the installation.

Disconnect fixture from power source before replacing bulbs. Make sure bulbs are given sufficient time to cool before removal. Do not subject glass parts to any shock while in operation or shattering may result.

Package Contents

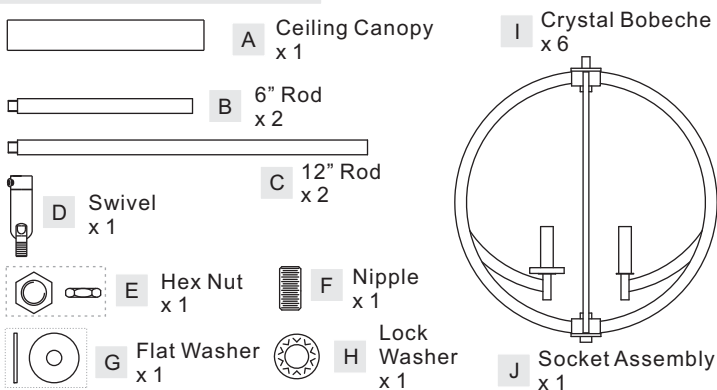

(Step 2A Continued)

Suggested rods for Ceiling height:
 8' ceiling : use (2) 6" rod
 9' ceiling : use (2) 6" rod and (1) 12" rod
 10' ceiling : use (2) 6" rods and (2) 12" rods

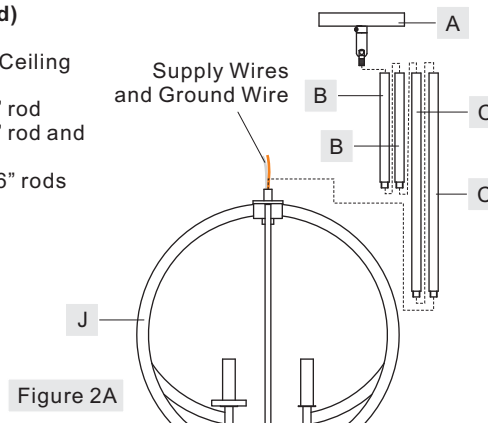

Hardware Contents

Crossbar Assembly x1 AA

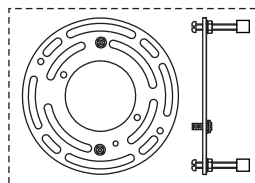

STEP 3A - Install Crossbar Assembly

A. Pass the supply wires through the Crossbar Assembly (AA). Attach the Crossbar Assembly (AA) to the Outlet Box with the head of the Green Ground Screw facing you. Secure it with Outlet Box Screws (not included). Tighten until snug.

Figure 3A

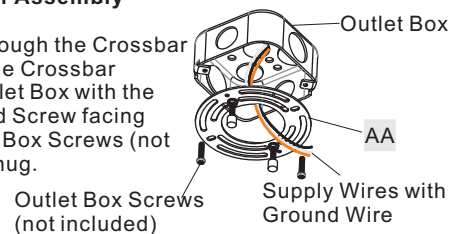

Assembly Instructions for Pendant Light (Step 1A - Step 7A)

STEP 1A - Assemble Swivel and Ceiling Canopy together

A. Thread the Nipple (F) onto the Swivel (D).
 B. Place the Ceiling Canopy (A), the Flat Washer (G) and the Lock Washer (H) over the Nipple (F). Secure them with the Hex Nut (E) and tighten until snug.

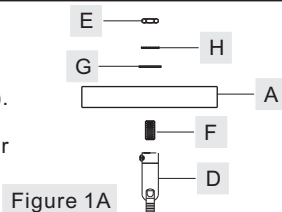

STEP 2A - Assemble the Rods and the Ceiling Canopy

A. Determine the Rods (B/C) to be assembled to the Socket Assembly (J) according to your hanging height.
 B. Pass the supply wires and ground wire through the chosen rods (B/C) and the Ceiling Canopy (A). Thread the Socket Assembly (J), the chosen Rods (B/C) and the Ceiling Canopy (A) together. Hand tighten until snug.

STEP 4A - Fit Ceiling Canopy to Crossbar Assembly

A. Remove mounting balls from the Crossbar Assembly (AA). Fit the Ceiling Canopy (A) to the Crossbar Assembly (AA) and secure with mounting balls. Note: The Ceiling Canopy (A) should be snug against the ceiling and the mounting balls. If Not, adjust the length of the nipple on the Crossbar Assembly (AA) by

unscrewing the preassembled hex nut and lock washer and then screwing the mounting screws in or out of the crossbar until the correct length is achieved. Once the Ceiling Canopy (A) is secure, remove the mounting ball and Ceiling Canopy (A) and proceed to Step 5A.

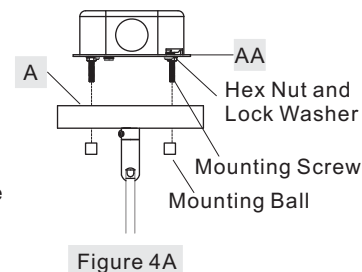

STEP 5A - Wire Connections

A. Use standard wire connectors (not included) to make all wire connections. (Connectors are not included with fixture.) Twist connectors until wires are tightly joined together. Wrap each connection with approved electrical tape and carefully stuff all the connected wires into the Outlet Box.

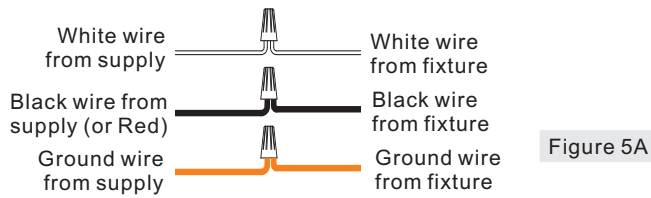

Figure 5A

STEP 6A - Install Fixture Body

A. Carefully tuck all wires into the outlet box and position the Ceiling Canopy (A) over the outlet box. Align the holes in the Ceiling Canopy (A) with the mounting screws, then attach the Ceiling Canopy (A) using the previously removed mounting balls. Hand tighten until snug.

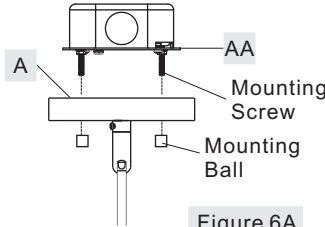

Figure 6A

STEP 7A - Install Crystal Bobeche and Bulb

A. Attach the Crystal Bobeche (I) over the Candle Cover.
 B. This fixture uses candelabra bulb with standard screw base. Maximum 60 watts. Insert bulb and screw snugly into place.

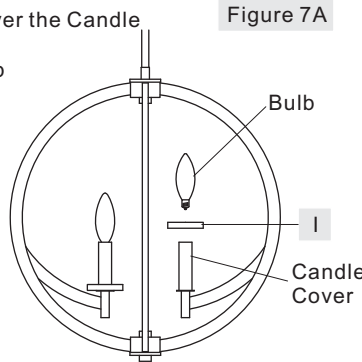
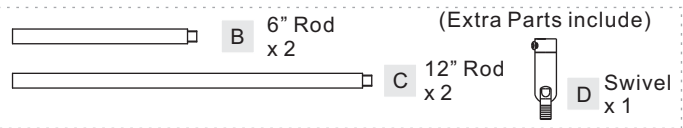

Figure 7A

Your fixture is now assembled and ready to use. Enjoy!

Assembly Instructions for Semi-flush Light (Step 1B - Step 6B)

Part B, Part C and Part E will not be used in the assembly of the Semi-Flush Light fixture. Please set aside these parts.



STEP 1B - Install Ceiling Canopy to Socket Assembly

A. Pass supply wires with ground wire through the Nipple (F), the Ceiling Canopy (A), the Flat Washer (G), the Lock Washer (H) and the Hex Nut (E). Thread the Nipple (F) onto the Socket Assembly (J). Place the Ceiling Canopy (A), the Flat Washer (G) and the Lock Washer (H) over the Nipple (F). Secure with the Hex Nut (E) and hand tighten until snug. Cut the wires leaving approximately 6" of wire extending from the Ceiling Canopy.

B. Optional Swivel: Install the Swivel to the Socket Assembly (J) and then attach the Nipple (F), the Ceiling Canopy (A), the Flat Washer (G) and the Lock Washer (H) to the Swivel. Secure with the Hex Nut (E) and tighten until snug.

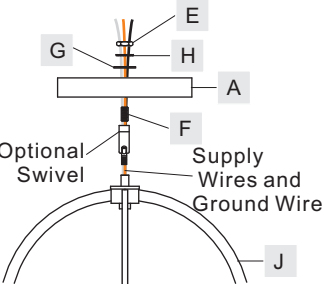

Figure 1B

STEP 2B - Install Crossbar Assembly

A. Pass the supply wires through the Crossbar Assembly (AA). Attach the Crossbar Assembly (AA) to the Outlet Box with the head of the Green Ground Screw facing you. Secure it with Outlet Box Screws (not included). Tighten until snug.

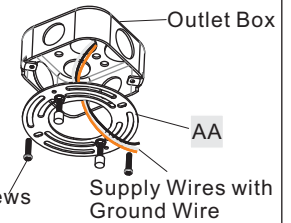

Figure 2B

STEP 3B - Fit Ceiling Canopy to Crossbar Assembly

A. Remove mounting balls from the Crossbar Assembly (AA). Fit the Ceiling Canopy (A) to the Crossbar Assembly (AA) and secure with mounting balls. Note: The Ceiling Canopy (A) should be snug against the ceiling and the mounting balls. If Not, adjust the length of the nipple on the Crossbar Assembly (AA) by

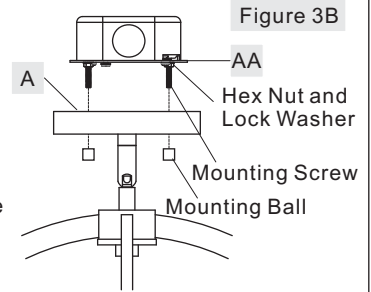

Figure 3B

unscrewing the preassembled hex nut and lock washer and then screwing the mounting screws in or out of the crossbar until the correct length is achieved. Once the Ceiling Canopy (A) is secure, remove the mounting ball and Ceiling Canopy (A) and proceed to Step 4B.

STEP 4B - Wire Connections

A. Use standard wire connectors (not included) to make all wire connections. (Connectors are not included with fixture.) Twist connectors until wires are tightly joined together. Wrap each connection with approved electrical tape and carefully stuff all the connected wires into the Outlet Box.

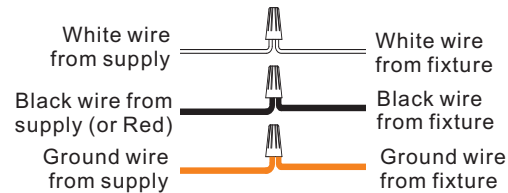

Figure 4B

STEP 5B - Install Fixture Body

A. Carefully tuck all wires into the outlet box and position the Ceiling Canopy (A) over the outlet box. Align the holes in the Ceiling Canopy (A) with the mounting screws, then attach the Ceiling Canopy (A) using the previously removed mounting balls. Hand tighten until snug.

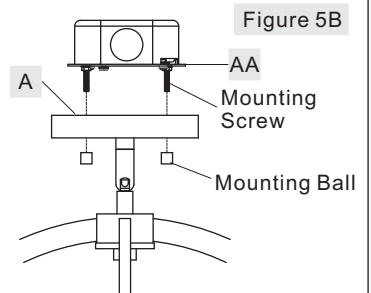

Figure 5B

STEP 6B - Install Crystal Bobeche and Bulb

A. Attach the Crystal Bobeche (I) over the Candle Cover.
 B. This fixture uses candelabra bulb with standard screw base. Maximum 60 watts. Insert bulb and screw snugly into place.

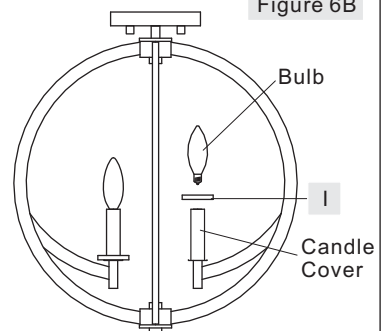
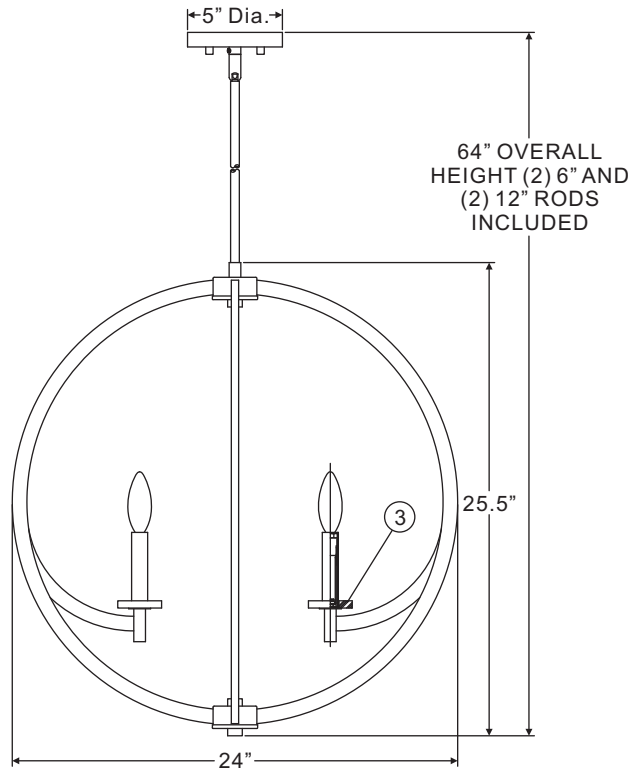
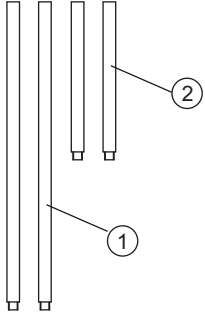
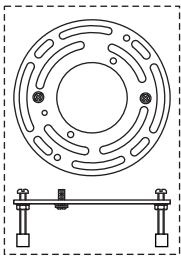

Figure 6B

Your fixture is now assembled and ready to use. Enjoy!

SKU: UQL2552

PENDANT LIGHT



SEMI-FLUSH

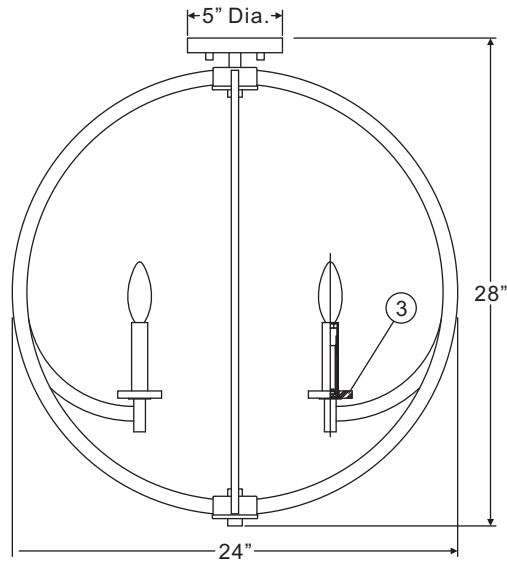
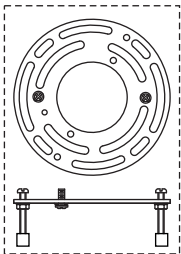

 (6) 60W Candelabra
 Base Bulbs
 (Not Supplied)

| NO. | PART NUMBER | REPLACEMENT PART | QTY. |
|-----|-------------|------------------|------|
| 1 | UQL2552EX6 | 6"L ROD | 2 |
| 2 | UQL2552EX12 | 12"L ROD | 2 |
| 3 | UQL2552CR | CRYSTAL BOBECHE | 2 |

NOTE: ALL DIMENSIONS ARE ROUNDED UP TO THE NEAREST 1/4"

urban ambiance

www.urbanambiance.com