

# urban ambiance

## UQL2405

INTERIOR BATHROOM FIXTURE

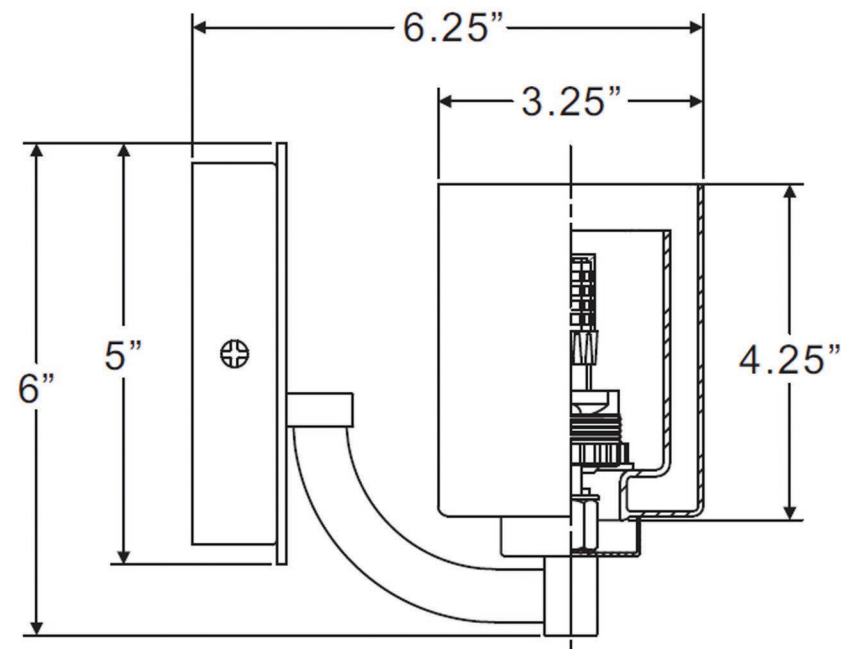
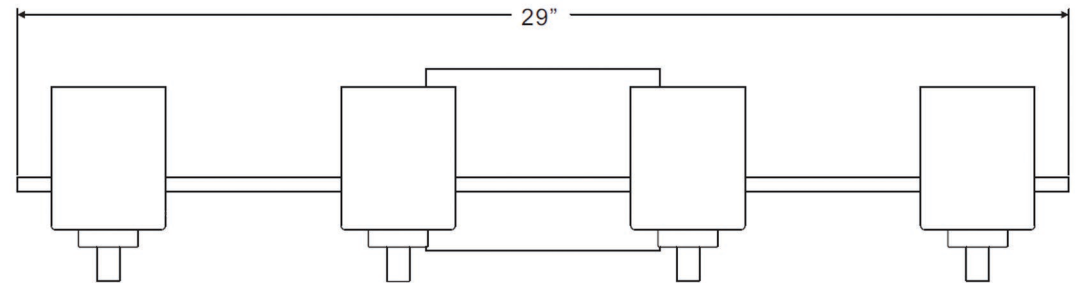

<b>Collection</b>	Napa
<b>Finish</b>	Brushed Nickel
<b>Shade</b>	Sand Blasted and Clear Glass
<b>Bulb Type</b>	Frosted G9 LED
<b>Bulb Wattage</b>	50
<b>Number of Bulbs</b>	4
<b>Bulbs Included</b>	Yes
<b>Certification</b>	ETL Listed
<b>Rated For</b>	Damp Locations
<b>Weight</b>	4.87 Pounds
<b>Chain Length</b>	N/A
<b>Extension Rods</b>	N/A
<b>Material Construction</b>	Steel-Glass