

Tools Required: Flathead screwdriver, Phillips screwdriver, pliers, wire cutters, wire strippers, electrical tape, safety glasses.

Light Source: (1) A19 Medium Base 100W Maximum, Alternate bulb (1) 23W CFL

Estimated Assembly Time: 30-45 minutes

Preparation: Identify and inspect all parts before beginning installation. Check package content list and diagrams below to be sure all parts are present. If any parts are missing or damaged, do not attempt to assemble, install, or operate the fixture. Contact customer service for replacement parts.

⚠ Warnings and Cautions

Turn off electricity at circuit breaker or main fuse box before installation. Consult a licensed electrician if in doubt.

These instructions are provided for your safety. It is very important you read them completely before installing the fixture. We strongly recommend that a licensed, professional electrician perform the installation.

Disconnect fixture from power source before replacing bulbs. Make sure bulbs are given sufficient time to cool before removal. Do not subject glass parts to any shock while in operation or shattering may result.

Package Contents

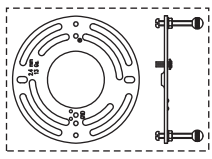

A Crossbar Assembly x 1

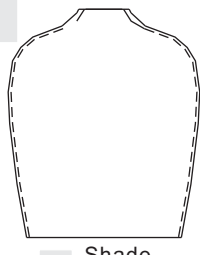

B Shade x 1



Fixture Body x 1



C Steel Collar x 1



D Socket Collar x 1

should be snug against the ceiling and the mounting balls. If Not, adjust the length of the nipple on the Crossbar Assembly (A) by unscrewing the preassembled hex nut and lock washer and then screwing the mounting screws in or out of the crossbar until the correct length is achieved. Once the Ceiling Canopy is secure, remove the mounting ball and Ceiling Canopy and proceed to Step 4.

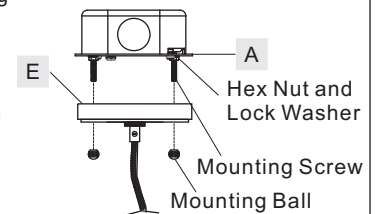

Figure 3

STEP 1 – Adjust Fixture Height

A. Adjust cord to your desired hanging height by pulling the wire in the direction you desire. With a screwdriver, remove the Screw to open the Wire Clasp in the ceiling canopy. Adjust the length of Wire to achieve your desired lamp height. Once lamp achieves your desired height, secure the lamp by reinstalling the Screw to Wire Clasp and tighten until snug.

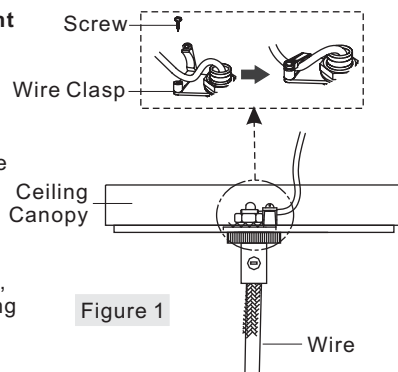

Figure 1

STEP 2 – Install Crossbar Assembly

A. Pass the supply wires through the Crossbar Assembly (A). Attach the Crossbar Assembly (A) to the Outlet Box with the head of the Green Ground Screw facing you. Secure it with Outlet Box Screws (not included). Tighten until snug.

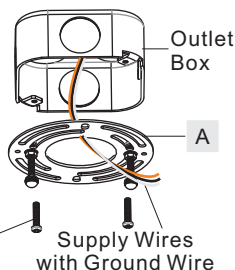

Figure 2

STEP 3 – Fit Ceiling Canopy to Crossbar Assembly

A. Remove mounting balls from the Crossbar Assembly (A). Fit the Ceiling Canopy of the Fixture Body (E) to the Crossbar Assembly (A) and secure with mounting balls. Note: The Ceiling Canopy

STEP 4 – Make Wire Connections

A. Use standard wire connectors to make all wire connections. (Connectors are not included with fixture.) Strip and prepare wire ends according to instructions supplied with connectors. Wrap each connection with approved electrical tape and carefully stuff all the connected wires into the Outlet Box.

Note: If the electrical wire is going to be cut shorter than provided you will need to identify the "L" line wire and the "N" wire before you cut the excess wire off. One is labeled N and the other labeled L. The third wire has a green stripe on it. To do this strip back the clear wire covering the 3 fixture wires as far as you need to. This will expose each fixture wire individually. Separate the "L" wire from the other two and re-label the wire near where you want to make the cut. Be sure to mark the wire on the side of the fixture and not on the excess wire being cut and removed. Do the same labeling with the "N" wire.

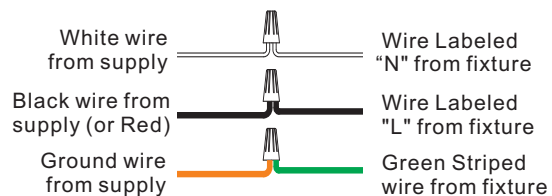

Figure 4

STEP 5 – Install Fixture Body

A. Carefully tuck all wires into the outlet box and position the Ceiling Canopy of the Fixture Body (E) over the outlet box. Align the holes in the Ceiling Canopy with the mounting screws, then attach the Ceiling Canopy using the previously removed mounting balls. Hand tighten until snug.

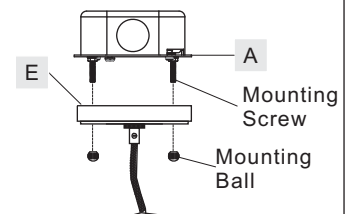
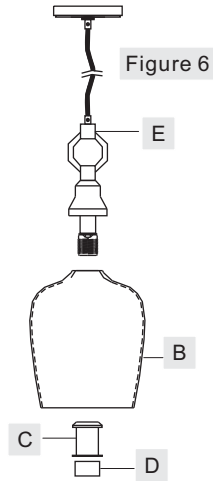

Figure 5

STEP 6 – Install Shade and Bulb

- A. Place the Shade (B) and the Steel Collar (C) over the Socket as shown. Secure by threading the Socket Collar (D) onto the Socket. Hand tighten until snug.
- B. This fixture uses standard bulb with a standard screw base. Maximum 100 watts. Insert bulb and screw properly into place.

Your fixture is now assembled and ready to use. Enjoy!



SKU: UQL2390

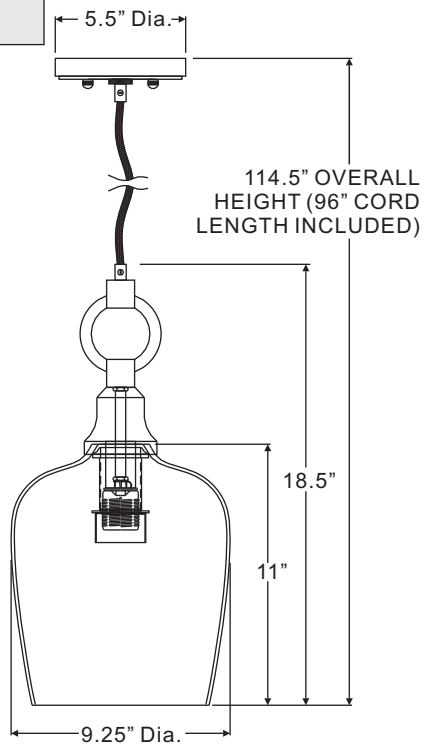

NOTE: ALL DIMENSIONS ARE ROUNDED UP TO THE NEAREST 1/4"



(1) 100W Medium Base Bulb (Not Supplied)

| NO. | PART NUMBER | REPLACEMENT PART | REQ. |
|-----|-------------|------------------|------|
| 1 | UQL2390SH | SHADE | 1 |

urban ambiance

www.urbanambiance.com