

Tools Required: Flathead screwdriver, Phillips screwdriver, pliers, wire cutters, wire strippers, electrical tape, safety glasses.

Light Source: (1) Medium Base 100W bulb Maximum, Alternate bulb (1) 23W CFL Maximum.

Estimated Assembly Time: 30-45 minutes

Preparation: Identify and inspect all parts before beginning installation. Check package content list and diagrams below to be sure all parts are present. If any parts are missing or damaged, do not attempt to assemble, install, or operate the fixture. Contact customer service for replacement parts.

Note: This **CONVERTIBLE** fixture can be mounted as pendant light or semi-flush light. Refer to respective installation steps for installations.

⚠ Warnings and Cautions

Turn off electricity at circuit breaker or main fuse box before installation. Consult a licensed electrician if in doubt.

These instructions are provided for your safety. It is very important you read them completely before installing the fixture. We strongly recommend that a licensed, professional electrician perform the installation.

Disconnect fixture from power source before replacing bulbs. Make sure bulbs are given sufficient time to cool before removal. Do not subject glass parts to any shock while in operation or shattering may result.

Package Contents

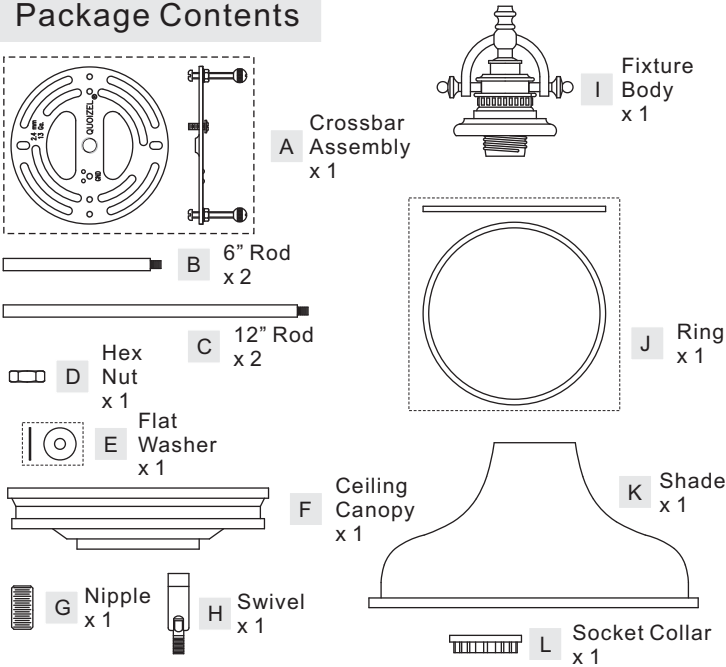

(Step 1A continued)

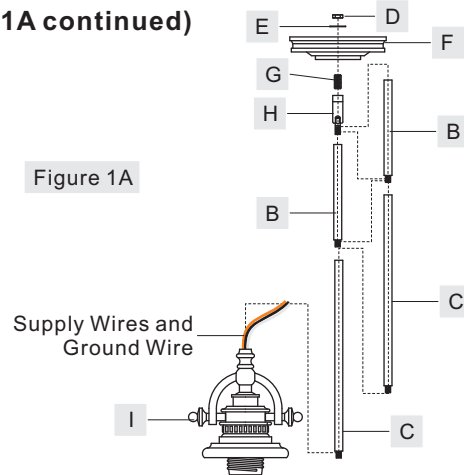

STEP 2A - Install Crossbar Assembly

A. Pass the supply wires through the Crossbar Assembly (A). Attach the Crossbar Assembly (A) to the Outlet Box with the head of the Green Ground Screw facing you. Secure it with Outlet Box Screws (not included). Tighten until snug.

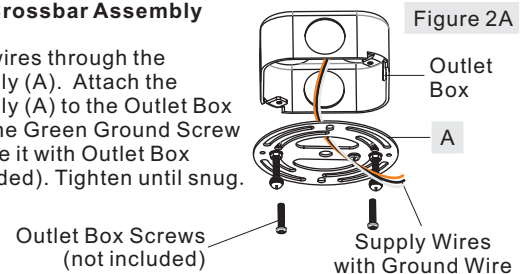

Assembly Instructions for Pendant Light (Step 1A - Step 7A)

STEP 1A - Install Ceiling Canopy, Rods and Socket Assembly together

- Thread Nipple (G) onto the Swivel (H). Place Ceiling Canopy (F) and Flat Washer (E) over the Nipple (G), secure by threading Hex Nut (D) onto the Nipple (G), tighten until snug.
- Determine the Rods (B/C) to be assembled to the Fixture Body (I) according to your hanging height.
- Pass the supply wires and ground wire through the chosen rods (B/C) and the Ceiling Canopy with Swivel. Thread the Fixture Body (I), the chosen Rods (B/C) and the Ceiling Canopy with Swivel together. Hand tighten until snug.

Suggested rods for Ceiling height :

8' ceiling : use (2) 12" rods

9' ceiling : use (2) 6" rods and (2) 12" rods

STEP 3A - Fit Ceiling Canopy to Crossbar Assembly

- Remove mounting balls from the Crossbar Assembly (A). Fit the Ceiling Canopy (F) to the Crossbar Assembly (AA) and secure with mounting balls. Note: The Ceiling Canopy (F) should be snug against the ceiling and the mounting balls. If not, adjust the length of the nipple on the Crossbar Assembly (A) by unscrewing the preassembled hex nut and lock washer and then screwing the mounting screws in or out of the crossbar until the correct length is achieved. Once the Ceiling Canopy (F) is secure, remove the mounting ball and Ceiling Canopy (F) and proceed to Step 4A.

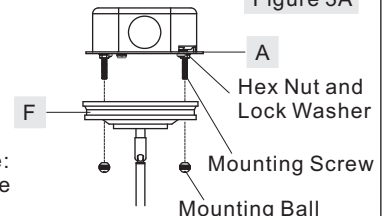

STEP 4A - Wire Connections

A. Use standard wire connectors (not included) to make all wire connections. (Connectors are not included with fixture.) Twist connectors until wires are tightly joined together. Wrap each connection with approved electrical tape and carefully stuff all the connected wires into the Outlet Box.

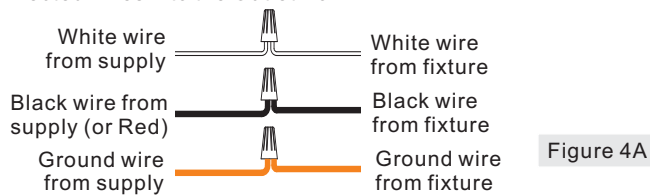

STEP 5A - Install Fixture Body

A. Carefully tuck all wires into the outlet box and position the Ceiling Canopy (F) over the outlet box. Align the holes in the Ceiling Canopy (F) with the mounting screws, then attach the Ceiling Canopy (F) using the previously removed mounting balls. Hand tighten until snug.

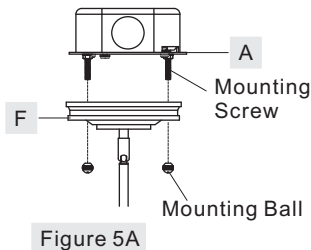

STEP 6A - Install Shade

A. Attach the Ring (J) to the Shade (K).
B. Place the Shade (K) with the Ring (J) over the Socket and secure with the Socket Collar (L). Hand tighten until snug.

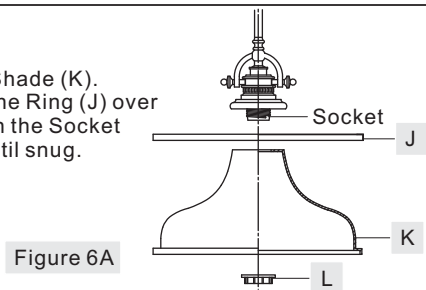

STEP 7A - Install Bulb

A. This fixture uses standard bulb with medium base. Maximum 100 watts. Insert bulb and screw snugly into place.

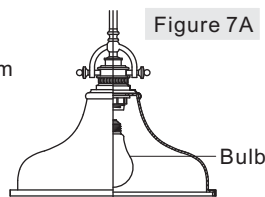

Your fixture is now assembled and ready to use. Enjoy!

Assembly Instructions for Semi-flush Light (Step 1B - Step 7B)

Part B, Part C and Part H will not be used in the assembly of the Semi-Flush Light fixture. Please set aside these parts.

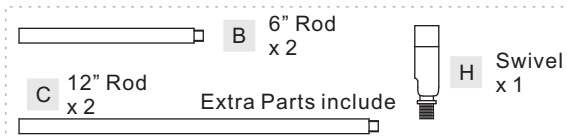

STEP 1B - Install Ceiling Canopy to Socket Assembly

A. Pass supply wires with ground wire through Nipple (G), Ceiling Canopy (F), Flat Washer (E) and Hex Nut (D). Thread Nipple (G) onto the Fixture Body (I). Place the Ceiling Canopy (F) and the Flat Washer (E) onto the Nipple (G). Secure by threading the Hex Nut (D) onto the Nipple (G). Hand tighten until snug. Cut the wires leaving approximately 6" of wire extending

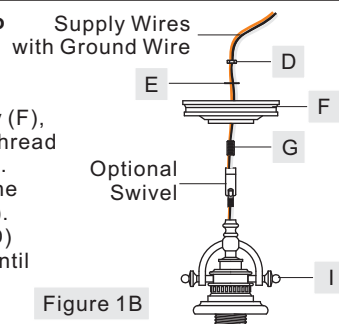

(Step 1B Continued)

from the Ceiling Canopy.
B. Optional Swivel: Install the swivel to the Fixture Body (I) and then attach Nipple (G) and the Ceiling Canopy (F) to the Swivel using the Flat Washer (E) and the Hex Nut (D).

STEP 2B - Install Crossbar Assembly

A. Pass the supply wires through the Crossbar Assembly (A). Attach the Crossbar Assembly (A) to the Outlet Box with the head of the Green Ground Screw facing you. Secure it with Outlet Box Screws (not included). Tighten until snug.

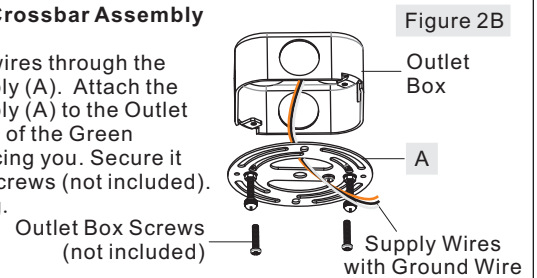

STEP 3B - Fit Ceiling Canopy to Crossbar Assembly

A. Remove mounting balls from the Crossbar Assembly (A). Fit the Ceiling Canopy (F) to the Crossbar Assembly (A) and secure with mounting balls. Note: The Ceiling Canopy (F) should be snug against the wall and the mounting balls. If not, adjust the length of the nipple on the Crossbar Assembly (A) by unscrewing the preassembled hex nut and lock washer and then screwing the mounting screws in or out of the crossbar until the correct length is achieved. Once the Ceiling Canopy (F) is secure, remove the mounting ball and Ceiling Canopy (F) and proceed to Step 4B.

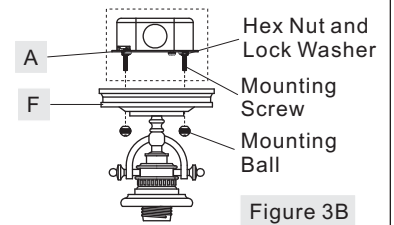

STEP 4B - Wire Connections

A. Use standard wire connectors (not included) to make all wire connections. (Connectors are not included with fixture.) Twist connectors until wires are tightly joined together. Wrap each connection with approved electrical tape and carefully stuff all the connected wires into the Outlet Box.

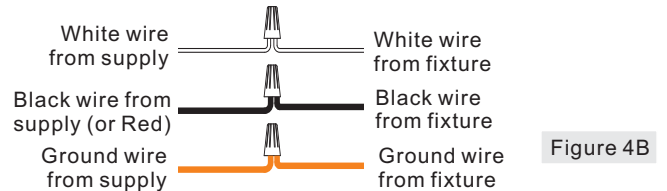

STEP 5B - Install Fixture Body

A. Carefully tuck all wires into the outlet box and position the Ceiling Canopy (F) over the outlet box. Align the holes in the Ceiling Canopy (F) with the mounting screws, then attach the Ceiling Canopy (F) using the previously removed mounting balls. Hand tighten until snug.

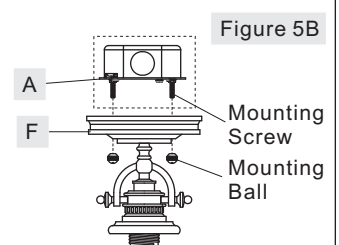

STEP 6B - Install Shade

A. Attach the Ring (J) to the Shade (K).
B. Place the Shade (K) with the Ring (J) over the Socket and secure with the Socket Collar (L). Hand tighten until snug.

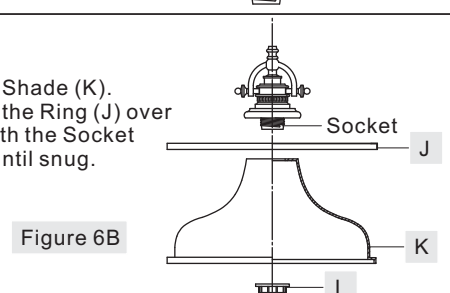

urban ambiance

www.urbanambiance.com

STEP 7B - Install Bulb

A. This fixture uses standard bulb with medium base. Maximum 100 watts.
Insert bulb and screw snugly into place.

Figure 7B

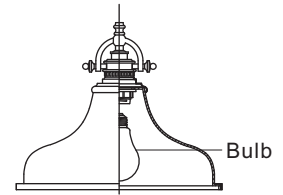

Your fixture is now assembled and ready to use. Enjoy!

SKU: UQL2333

PENDANT

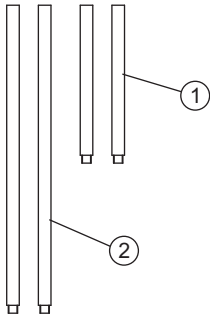
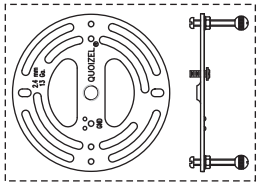

SEMI-FLUSH

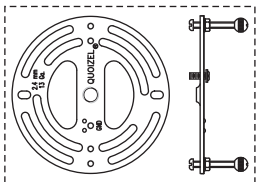

(1) 100W Medium Base Bulb
(Not Supplied)

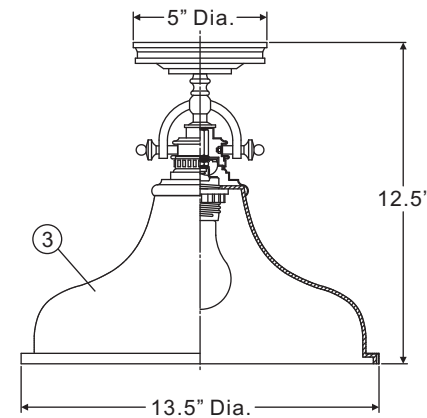
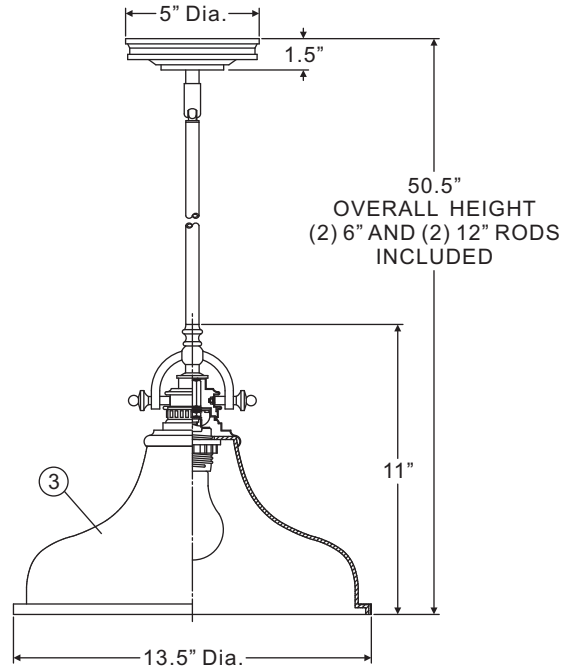

NOTE: ALL DIMENSIONS ARE ROUNDED UP TO THE NEAREST 1/2"

NO.	PART NUMBER	REPLACEMENT	REQ.
1	UQL2333EX6	6"L ROD	2
2	UQL2333EX12	12"L ROD	2
1	UQL2333SH	6"L ROD	2

urban ambiance

www.urbanambiance.com