

Tools Required: Flathead screwdriver, Phillips screwdriver, pliers, wire cutters, wire strippers, electrical tape, safety glasses.

Light Source: (1) Medium Base 100W bulb Maximum, Alternate bulb (1) 23W CFL Maximum.

Estimated Assembly Time: 30-45 minutes

Preparation: Identify and inspect all parts before beginning installation. Check package content list and diagrams below to be sure all parts are present. If any parts are missing or damaged, do not attempt to assemble, install, or operate the fixture. Contact customer service for replacement parts.

Note: This CONVERTIBLE fixture can be mounted as pendant light or semi-flush light. Refer to respective installation steps for installations.

⚠ Warnings and Cautions

Turn off electricity at circuit breaker or main fuse box before installation. Consult a licensed electrician if in doubt.

These instructions are provided for your safety. It is very important you read them completely before installing the fixture. We strongly recommend that a licensed, professional electrician perform the installation.

Disconnect fixture from power source before replacing bulbs. Make sure bulbs are given sufficient time to cool before removal. Do not subject glass parts to any shock while in operation or shattering may result.

Package Contents

- A Crossbar Assembly x 1
- B 6" Rod x 2
- C 12" Rod x 2
- D Hex Nut x 3
- E Flat Washer x 1
- F Ceiling Canopy x 1
- G Nipple x 1
- H Swivel x 1
- I Fixture Body x 1
- J Upper Collar x 1
- K Shade x 1
- L Steel Collar x 1
- M Harp with Socket Collar x 1
- N Nipple x 1
- O Flat Washer x 1
- P Rubber Washer x 1
- Q Diffuser x 1
- R Small Flat Washer x 1
- S Finial x 1

(Continue to Step 1A) according to your hanging height.

C. Pass the supply wires and ground wire through the chosen rods (B/C) and the Ceiling Canopy with Swivel. Thread the Fixture Body (I), the chosen Rods (B/C) and the Ceiling Canopy with Swivel together. Hand tighten until snug.

Suggested rods for Ceiling height :
 8' ceiling : use (2) 12" rods
 9' ceiling : use (2) 6" rods and (2) 12" rod

Figure 1A

Assembly Instructions for Pendant Light (Step 1A - Step 7A)

STEP 1A - Install Ceiling Canopy, Rods and Socket Assembly together

A. Thread Nipple (G) onto the Swivel (H). Place Ceiling Canopy (F) and Flat Washer (E) over the Nipple (G), secure by threading Hex Nut (D) onto the Nipple (G), tighten until snug.

B. Determine the Rods (B/C) to be assembled to the Fixture Body (I)

STEP 2A - Install Crossbar Assembly

A. Pass the supply wires through the Crossbar Assembly (A). Attach the Crossbar Assembly (A) to the Outlet Box with the head of the Green Ground Screw facing you. Secure it with Outlet Box Screws (not included). Tighten until snug.

Figure 2A

STEP 3A - Fit Ceiling Canopy to Crossbar Assembly

A. Remove mounting balls from the Crossbar Assembly (A). Fit the Ceiling Canopy (F) to the Crossbar Assembly (AA) and secure with mounting balls. Note: The Ceiling Canopy (F) should be snug against the ceiling and the mounting balls. If

Figure 3A

not, adjust the length of the nipple on the Crossbar Assembly (A) by unscrewing the preassembled hex nut and lock washer and then screwing the mounting screws in or out of the crossbar until the correct length is achieved. Once the Ceiling Canopy (F) is secure, remove the mounting ball and Ceiling Canopy (F) and proceed to Step 4A.

STEP 4A - Wire Connections

A. Use standard wire connectors (not included) to make all wire connections. (Connectors are not included with fixture.) Twist connectors until wires are tightly joined together. Wrap each connection with approved electrical tape and carefully stuff all the connected wires into the Outlet Box.

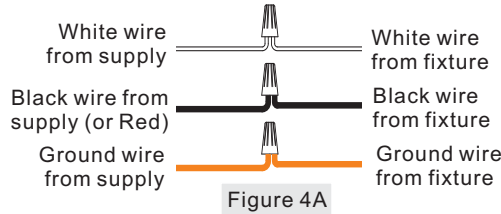

Figure 4A

STEP 5A - Install Fixture Body

A. Carefully tuck all wires into the outlet box and position the Ceiling Canopy (F) over the outlet box. Align the holes in the Ceiling Canopy (F) with the mounting screws, then attach the Ceiling Canopy (F) using the previously removed mounting balls. Hand tighten until snug.

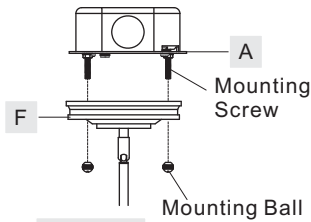

Figure 5A

STEP 6A - Install Shade and Bulb

A. Place the Upper Collar (J), the Shade (K) and the Steel Collar (L) in turn and secure with the Harp with Socket Collar (M). Hand tighten until snug.
B. This fixture uses standard bulb with medium base. Maximum 100 watts. Insert bulb and screw snugly into place.

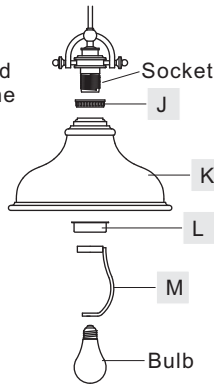

Figure 6A

STEP 7A - Install Diffuser

A. Thread one Hex Nut (D) to the Nipple (N) approx half way. Screw the Nipple (N) into the bottom end of the Harp (M) and tighten until snug. By using pliers, thread the Hex Nut (D) against the Harp (M) and hand tighten until snug.
B. Thread another Hex Nut (D) onto the end of the Nipple (N) and adjust it to proper location for rest components. Attach the Flat Washer (O), the Rubber Washer (P), the Diffuser (R) and the Small Flat Washer (S) over the Nipple (N) in turn. Secure them with the Finial (T) and hand tighten until snug.

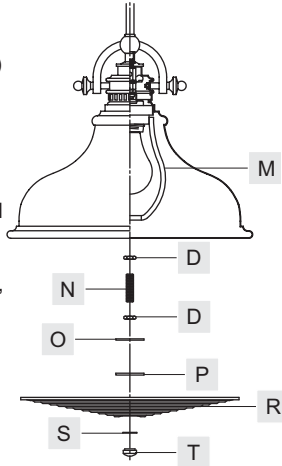
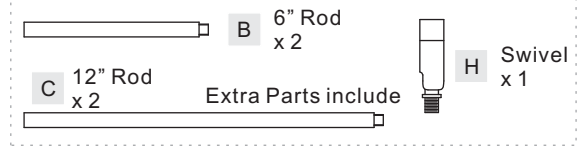

Figure 7A

Your fixture is now assembled and ready to use. Enjoy!

Assembly Instructions for Semi-flush Light (Step 1B - Step 7B)

Part B, Part C and Part H will not be used in the assembly of the Semi-Flush Light fixture. Please set aside these parts.



STEP 1B - Install Ceiling Canopy to Socket Assembly

A. Pass supply wires with ground wire through Nipple (G), Ceiling Canopy (F), Flat Washer (E) and Hex Nut (D). Thread Nipple (G) onto the Fixture Body (I). Place the Ceiling Canopy (F) and the Flat Washer (E) onto the Nipple (G). Secure by threading the Hex Nut (D) onto the Nipple (G). Hand tighten until snug. Cut the wires leaving approximately 6" of wire extending from the Ceiling Canopy.
B. Optional Swivel: Install the swivel to the Fixture Body (I) and then attach Nipple (G) and the Ceiling Canopy (F) to the Swivel using the Flat Washer (E) and the Hex Nut (D).

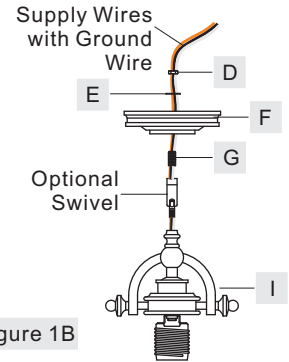

Figure 1B

STEP 2B - Install Crossbar Assembly

A. Pass the supply wires through the Crossbar Assembly (A). Attach the Crossbar Assembly (A) to the Outlet Box with the head of the Green Ground Screw facing you. Secure it with Outlet Box Screws (not included). Tighten until snug.

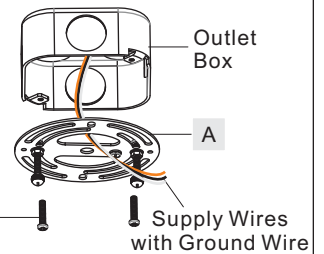

Figure 2B

STEP 3B - Fit Ceiling Canopy to Crossbar Assembly

A. Remove mounting balls from the Crossbar Assembly (A). Fit the Ceiling Canopy (F) to the Crossbar Assembly (A) and secure with mounting balls. Note: The Ceiling Canopy (F) should be snug against the wall and the mounting balls. If not, adjust the length of the nipple on the Crossbar Assembly (A) by unscrewing the preassembled hex nut and lock washer and then screwing the mounting screws in or out of the crossbar until the correct length is achieved. Once the Ceiling Canopy (F) is secure, remove the mounting ball and Ceiling Canopy (F) and proceed to Step 4B.

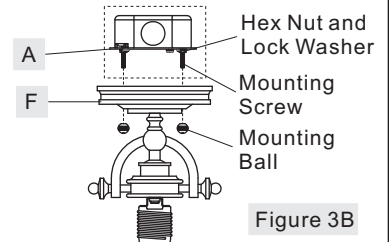

Figure 3B

STEP 4B - Wire Connections

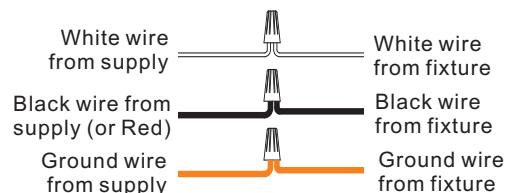

Figure 4B

urban ambiance

www.urbanambiance.com

(Continue to Step 4B)

A. Use standard wire connectors (not included) to make all wire connections. (Connectors are not included with fixture.) Twist connectors until wires are tightly joined together. Wrap each connection with approved electrical tape and carefully stuff all the connected wires into the Outlet Box.

STEP 5B – Install Fixture Body

A. Carefully tuck all wires into the outlet box and position the Ceiling Canopy (F) over the outlet box. Align the holes in the Ceiling Canopy (F) with the mounting screws, then attach the Ceiling Canopy (F) using the previously removed mounting balls. Hand tighten until snug.

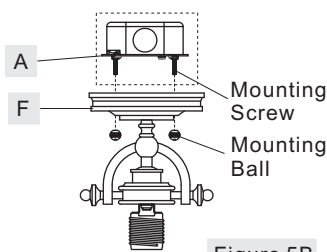

Figure 5B

STEP 6B – Install Shade and Bulb

A. Place the Upper Collar (J), the Shade (K) and the Steel Collar (L) in turn and secure with the Harp with Socket Collar (M). Hand tighten until snug.
 B. This fixture uses standard bulb with medium base. Maximum 100 watts. Insert bulb and screw snugly into place.

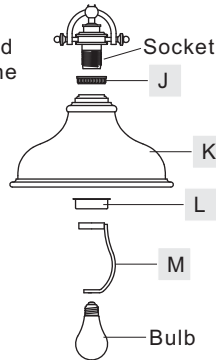

Figure 6B

STEP 7B – Install Diffuser

A. Thread one Hex Nut (D) to the Nipple (N) approx half way. Screw the Nipple (N) into the bottom end of the Harp (M) and tighten until snug. By using pliers, thread the Hex Nut (D) against the Harp (M) and hand tighten until snug.
 B. Thread another Hex Nut (D) onto the end of the Nipple (N) and adjust it to proper location for rest components. Attach the Flat Washer (O), the Rubber Washer (P), the Diffuser (R) and the Small Flat Washer (S) over the Nipple (N) in turn. Secure them with the Finial (T) and hand tighten until snug.

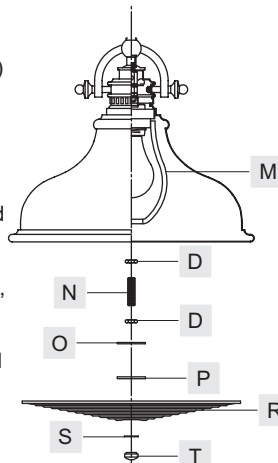
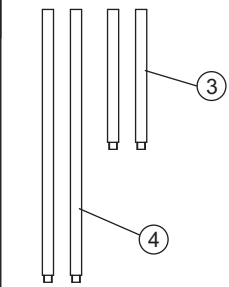
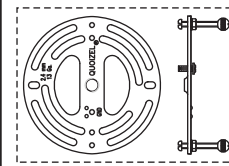

Figure 7B

Your fixture is now assembled and ready to use. Enjoy!

SKU: UQL2288

PENDANT



SEMI-FLUSH

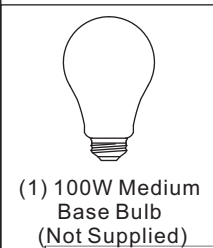
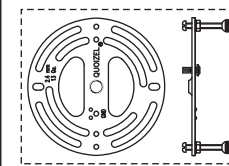

(1) 100W Medium Base Bulb (Not Supplied)

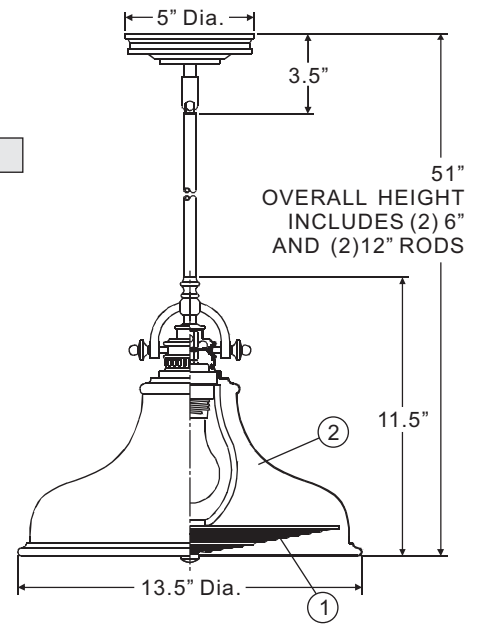

NOTE: ALL DIMENSIONS ARE ROUNDED UP TO THE NEAREST 1/4"

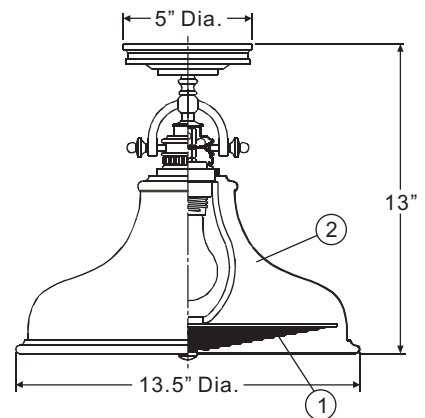

NO.	PART NUMBER	REPLACEMENT	REQ.	STYLE NUMBER
1	UQL2288DI	DIFFUSER	1	
2	UQL2288SH	METAL SHADE	1	
3	UQL2288EX6	6" ROD	2	
4	UQL2288EX12	12" ROD	2	