

### Tools Required

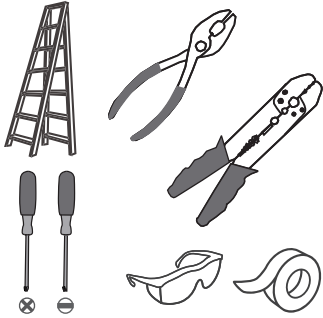

### Light Source

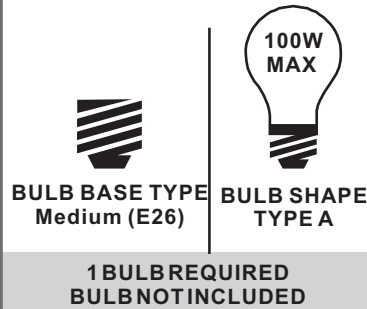

### Warnings and Cautions

Turn off the electricity at the circuit breaker before installation. Consult a licensed electrician if in doubt about installation.

Turn off power to the fixture and allow the bulbs to cool before replacing.

### Package Contents

**Preparation:** Identify and inspect all parts before beginning the installation.





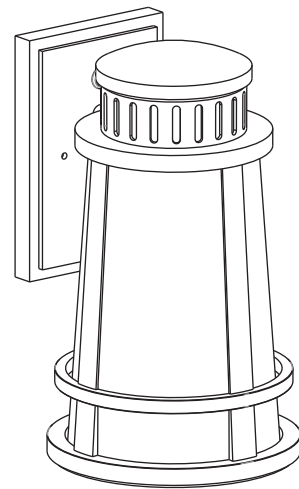
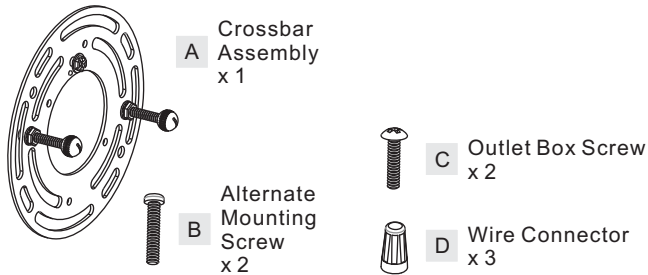

Missing or damaged parts? Contact your original place of purchase.

#### PARTS BAG

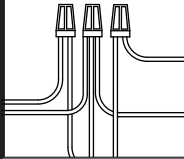
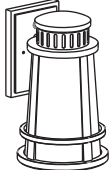

E Fixture Body x 1

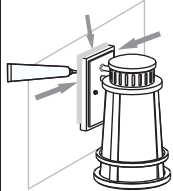
### Table of Contents

Alternate Mounting Screw	Crossbar Assembly	Wiring	Fixture Body	Bulb	Caulk	Replace Glass
						
STEP 1	STEP 2	STEP 3	STEP 4	STEP 5	STEP 6	STEP 7

# STEP 1

OPTION 1

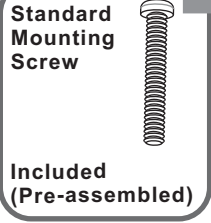

skip to next page

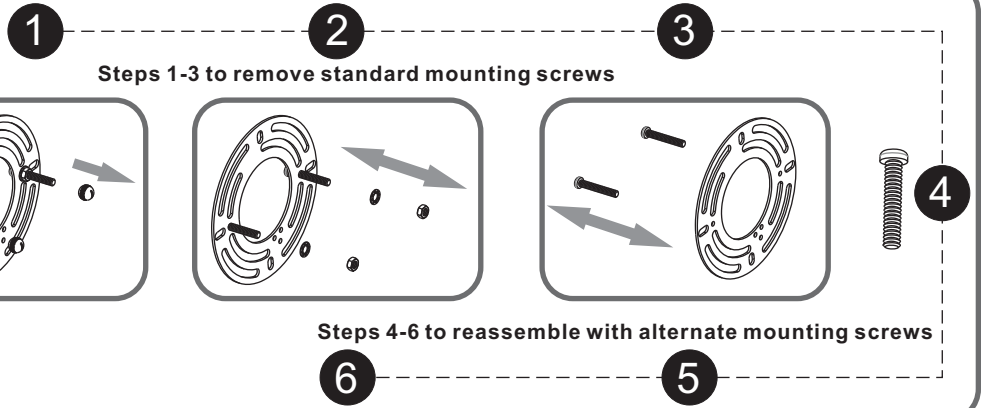

OPTION 2

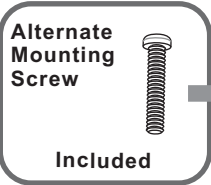

# STEP 2

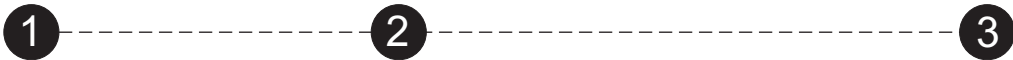

Step 1  
Install crossbar assembly

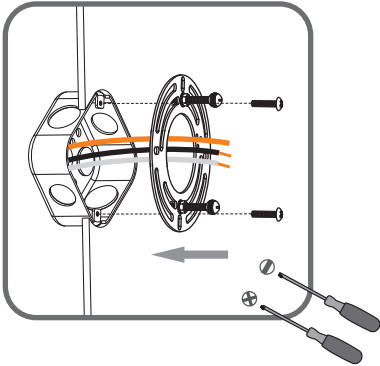

Step 2 - 3  
Test fitting backplate to mounting screws

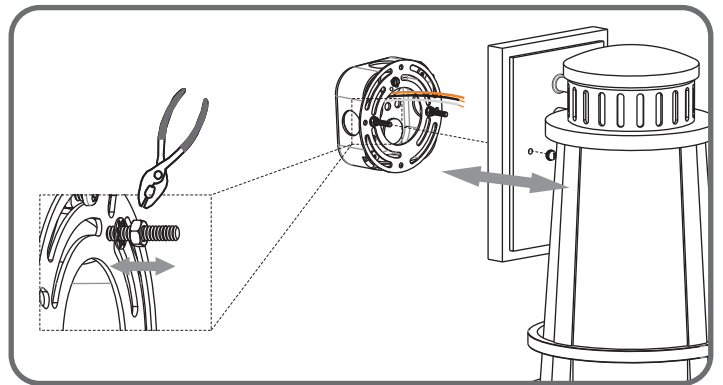
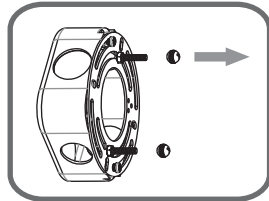

# STEP 3

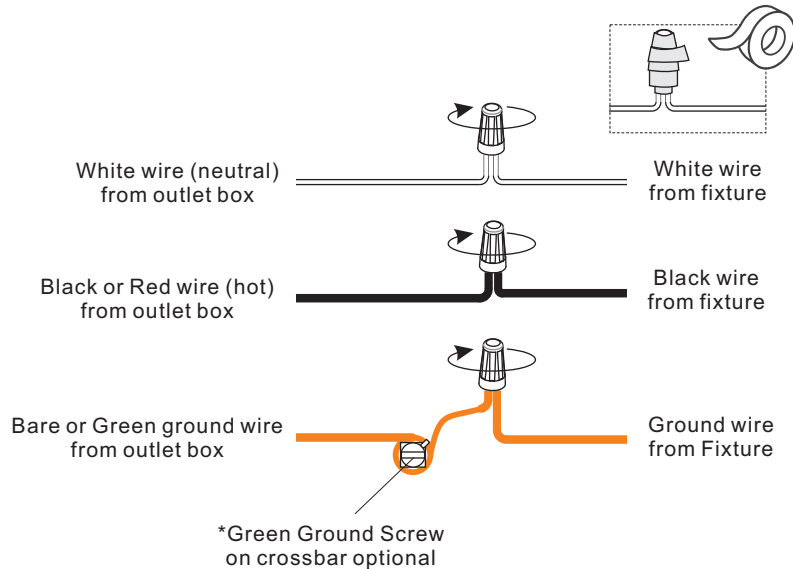

**STEP 4**

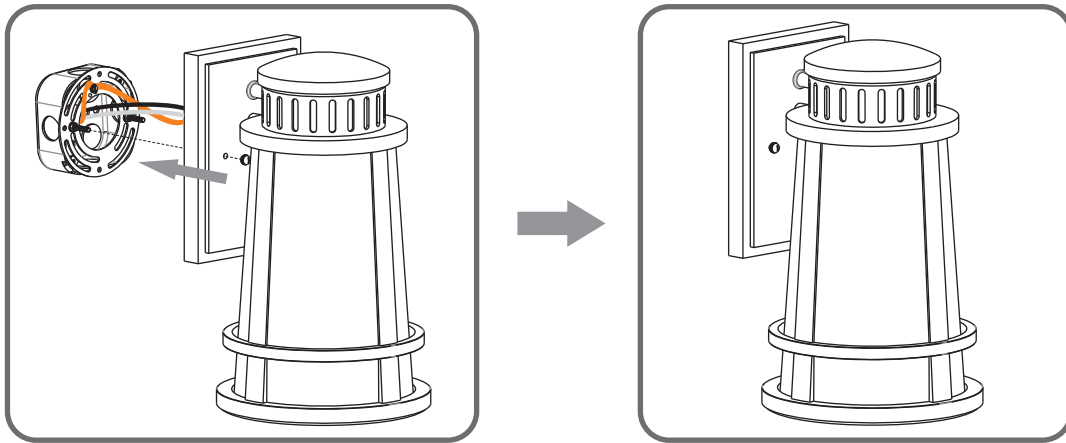

**STEP 5**

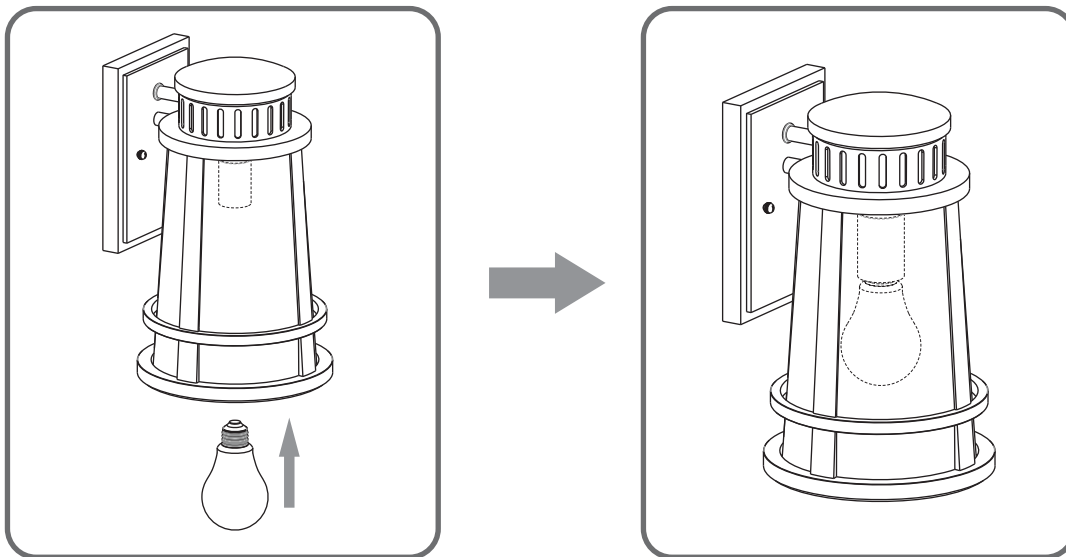

**STEP 6**

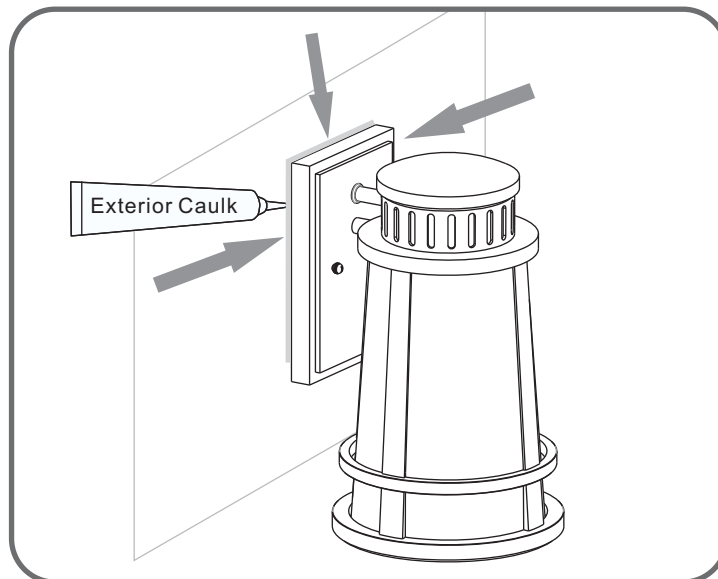

# STEP 7 - How to Replace Glass

1

Remove glass holder

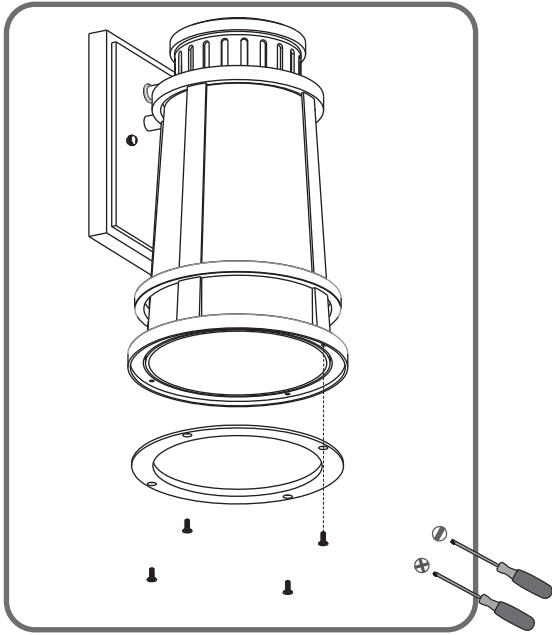

Reinstall glass holder

3

2

Replace glass

