

Tools Required

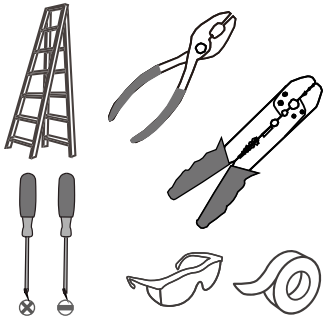

Light Source

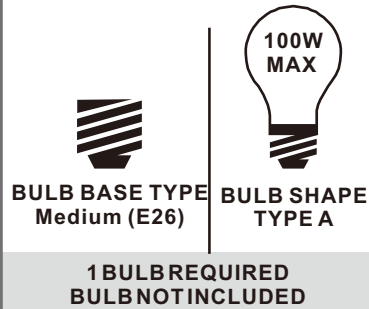

Warnings and Cautions

Turn off the electricity at the circuit breaker before installation. Consult a licensed electrician if in doubt about installation.

Turn off power to the fixture and allow the bulbs to cool before replacing.

Package Contents

Preparation: Identify and inspect all parts before beginning the installation.

Missing or damaged parts? Contact your original place of purchase.

PARTS BAG

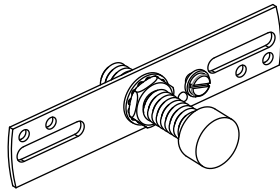

A Crossbar Assembly x 1



B Outlet Box Screw x 2



C Wire Connector x 3

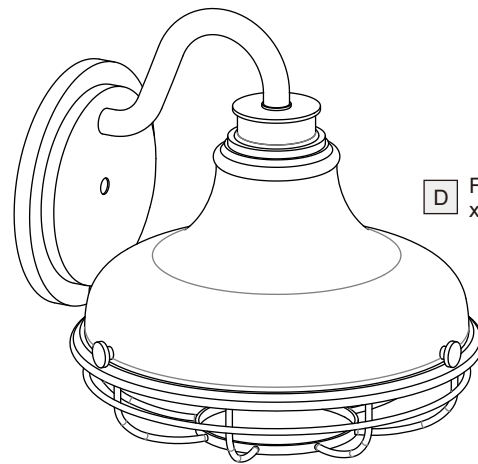

D Fixture Body x 1

Table of Contents

Crossbar Assembly	Wiring	Fixture Body	Bulb	Caulk
STEP 1	STEP 2	STEP 3	STEP 4	STEP 5

STEP 1

1

Step 1
Install crossbar assembly

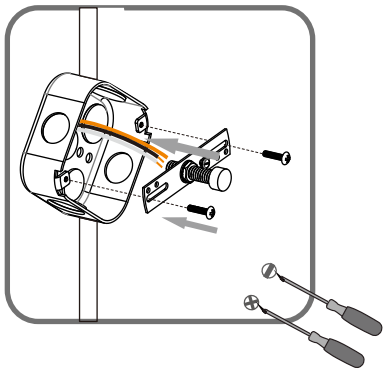

2

Step 2 - 3
Test fitting backplate to mounting screws

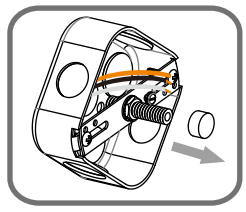

3

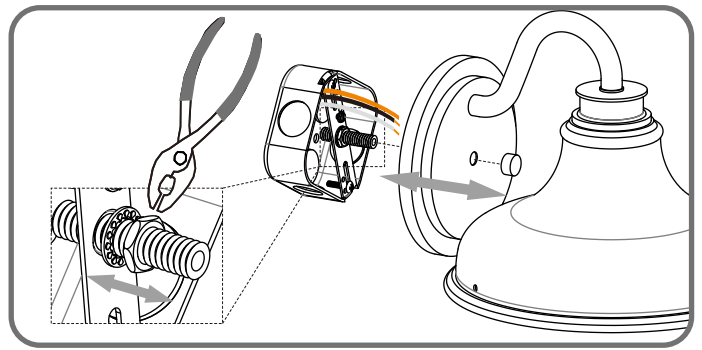

STEP 2

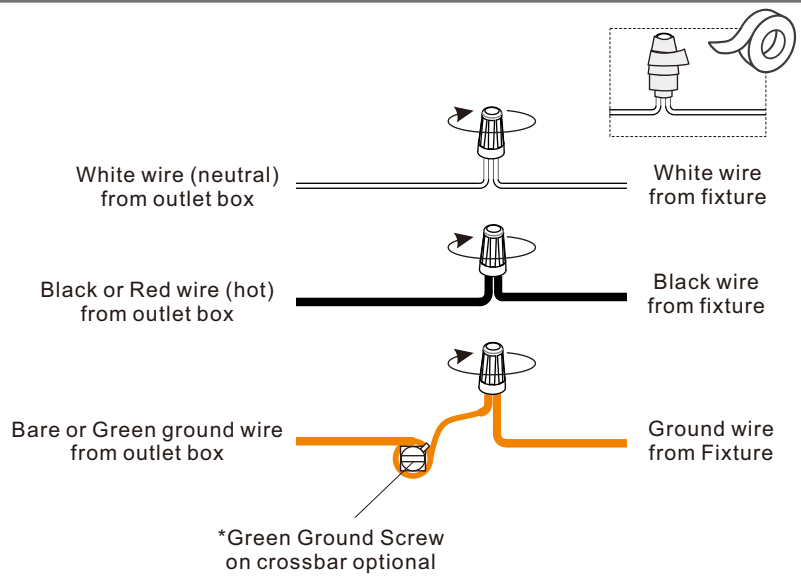

STEP 3

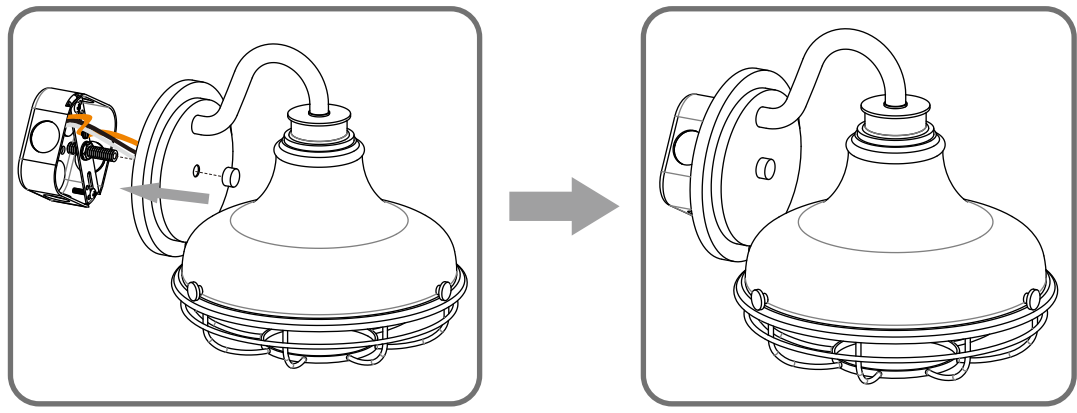

STEP 4

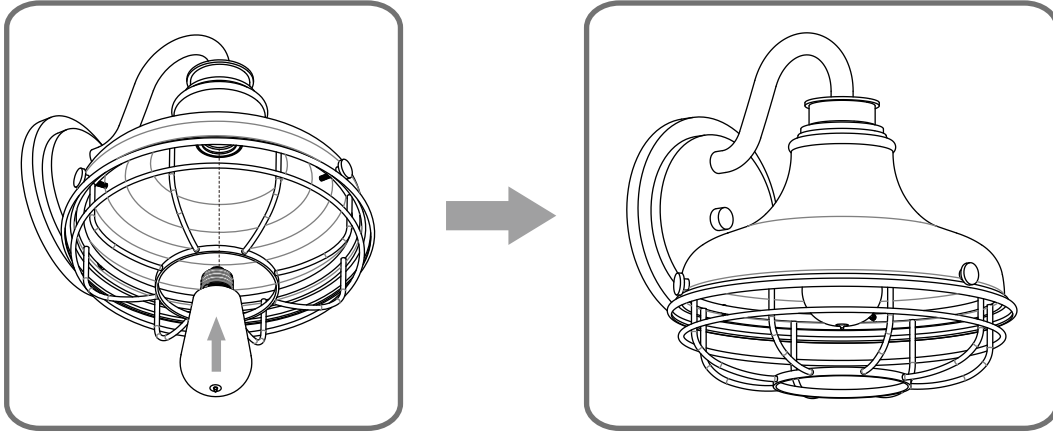

STEP 5

