

Tools Required

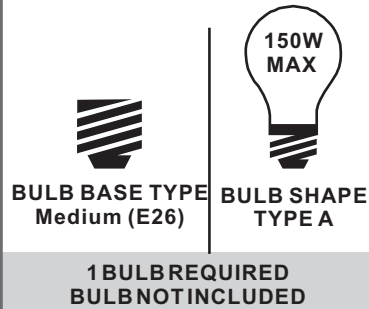

Light Source



Warnings and Cautions

Turn off the electricity at the circuit breaker before installation. Consult a licensed electrician if in doubt about installation.

Turn off power to the fixture and allow the bulbs to cool before replacing.

Package Contents

Preparation: Identify and inspect all parts before beginning the installation. Missing or damaged parts? Contact your original place of purchase.

PARTS BAG

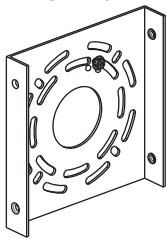

A Inner Backplate
x 1

B Lock Screw
x 4

C Outlet Box Screw
x 2

D Wire Connector
x 3

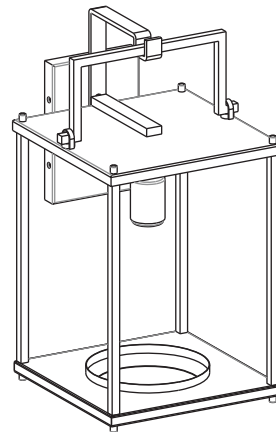

E Fixture Body
x 1

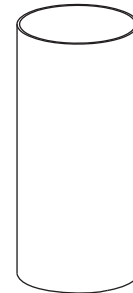

F Glass
x 1

Table of Contents

Glass	Inner Backplate	Wiring	Fixture Body	Bulb	Caulk
STEP 1	STEP 2	STEP 3	STEP 4	STEP 5	STEP 6

STEP 1

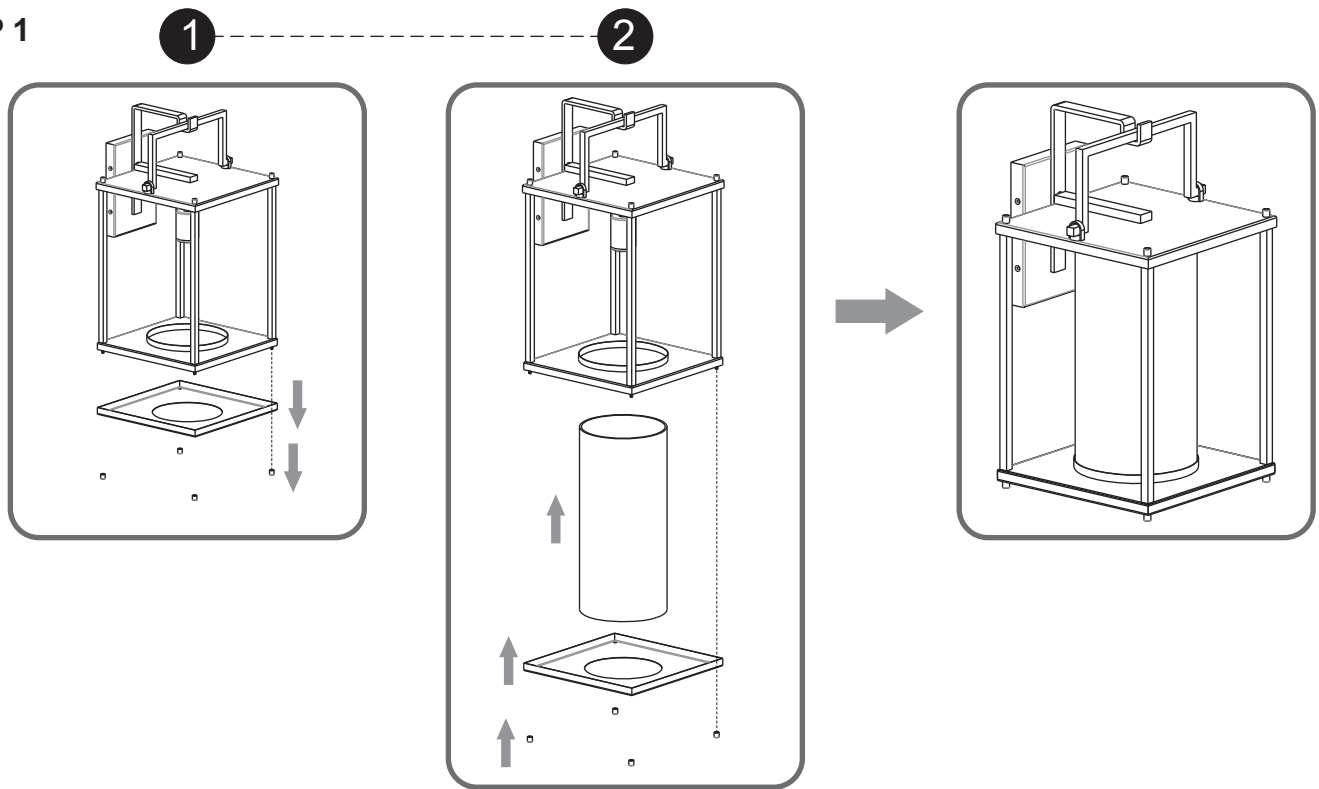

STEP 2

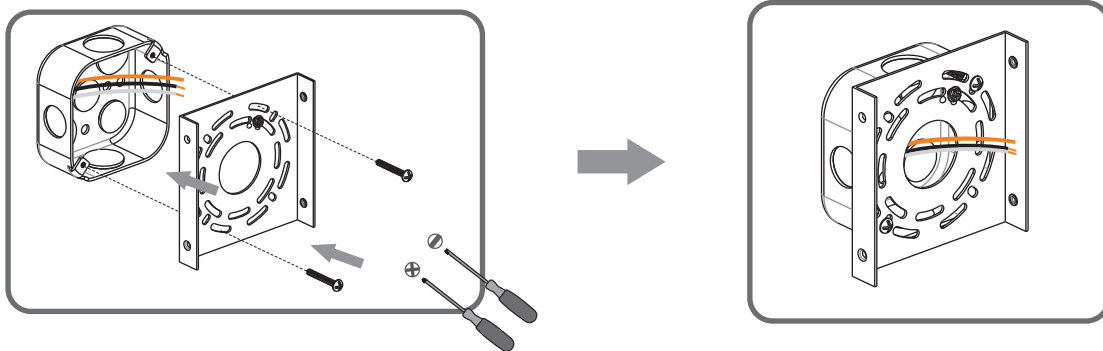

STEP 3

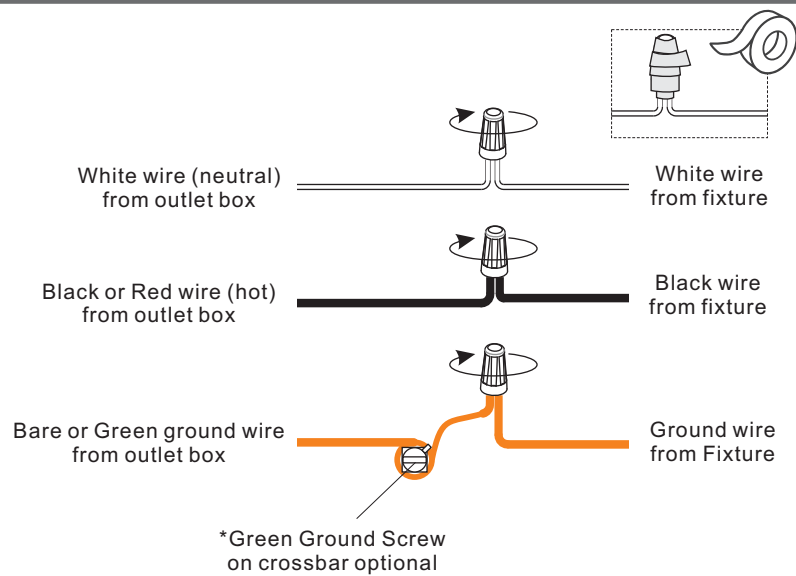

STEP 4

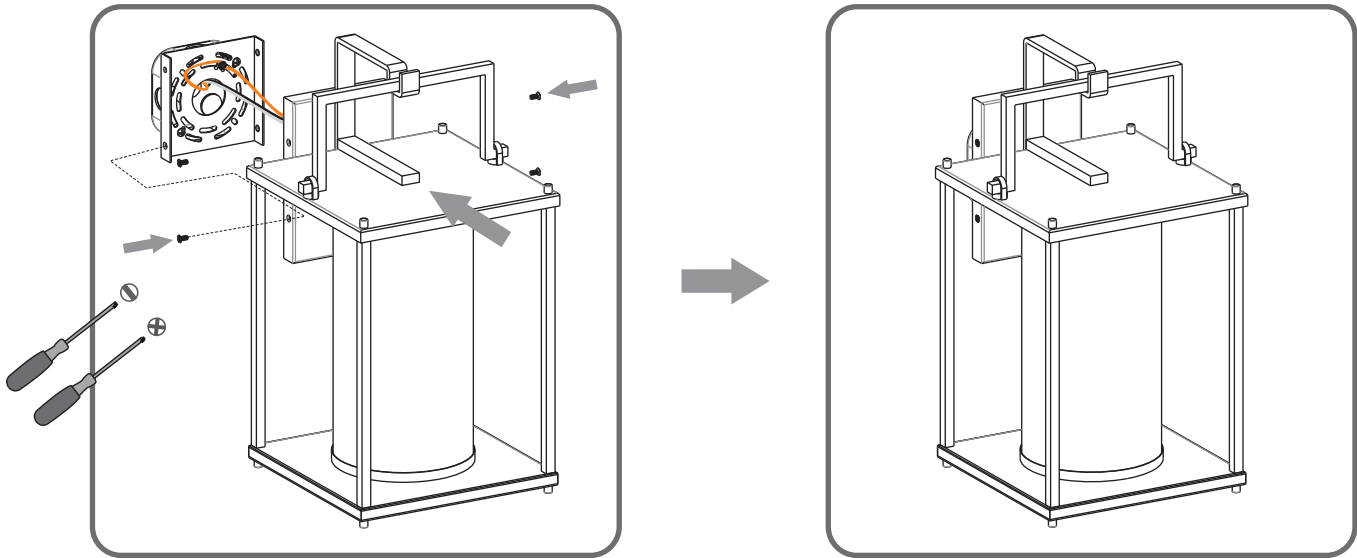

STEP 5

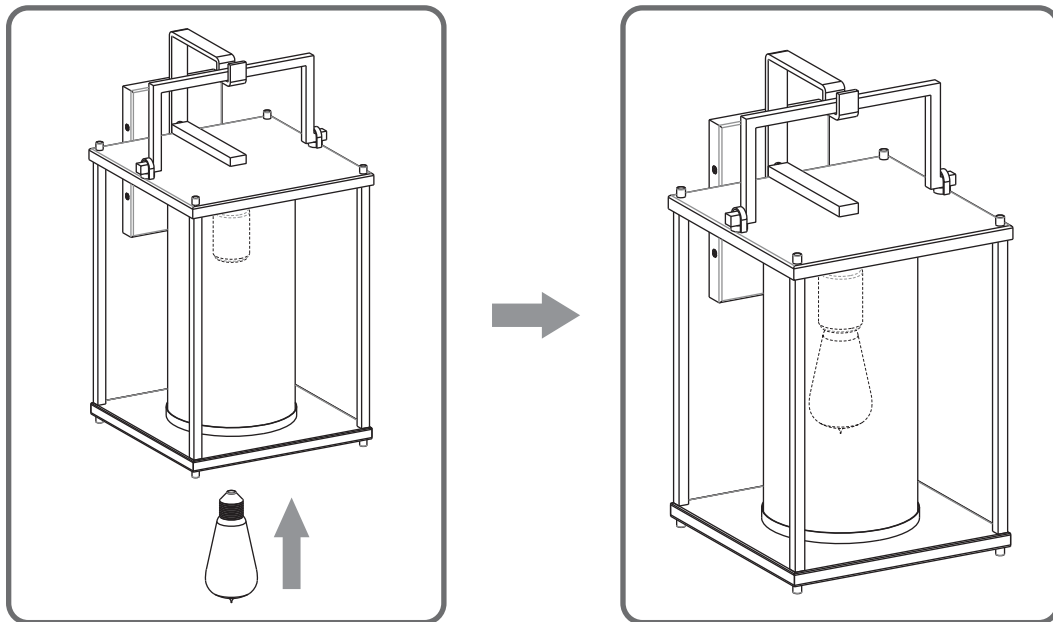

STEP 6

