

Tools Required

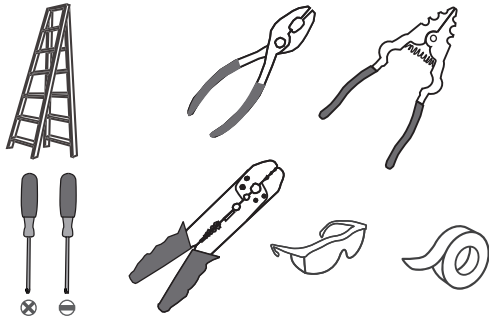

Light Source

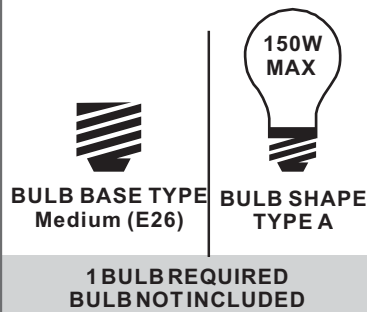

Fixture Height Adjustable 26.75" to 122.75"

⚠ Warnings and Cautions

Turn off the electricity at the circuit breaker before installation. Consult a licensed electrician if in doubt about installation.

Turn off power to the fixture and allow the bulbs to cool before replacing.

Package Contents

Preparation: Identify and inspect all parts before beginning the installation.

Missing or damaged parts? Contact your original place of purchase.

PARTS BAG

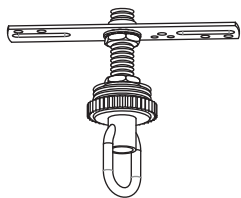

A Crossbar Assembly
x 1



B Outlet Box Screw
x 2



C Wire Connector
x 3

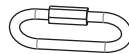

D Quick Link
x 2

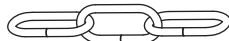

E Fixture Chain
x 1

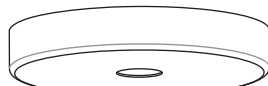

F Ceiling Canopy
x 1

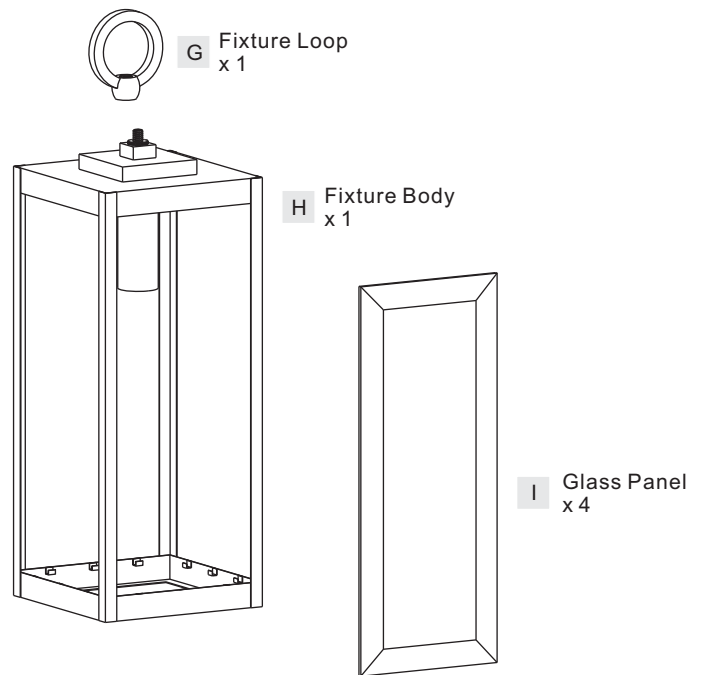

G Fixture Loop
x 1

H Fixture Body
x 1

I Glass Panel
x 4

Table of Contents

Glass Panels & Fixture Loop	Crossbar Assembly	Fixture Chain	Wiring	Ceiling Canopy	Bulb
STEP 1	STEP 2	STEP 3	STEP 4	STEP 5	STEP 6

STEP 1

1

Install Glass Panel

2

Install Fixture Loop

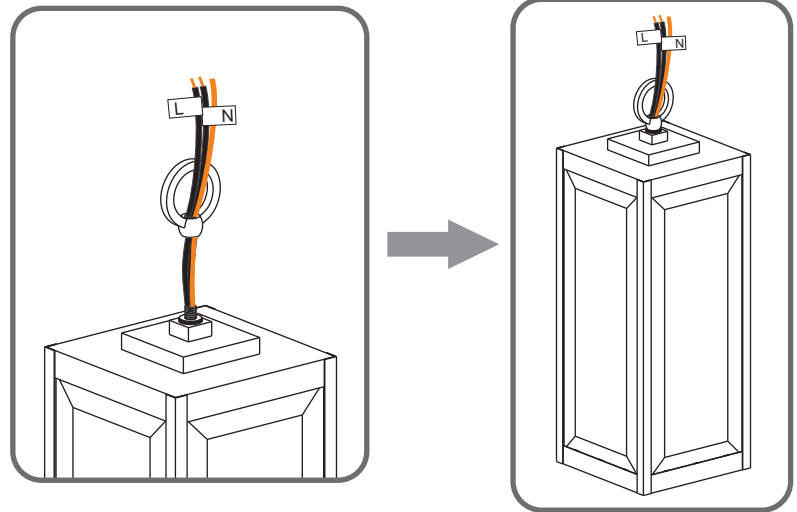
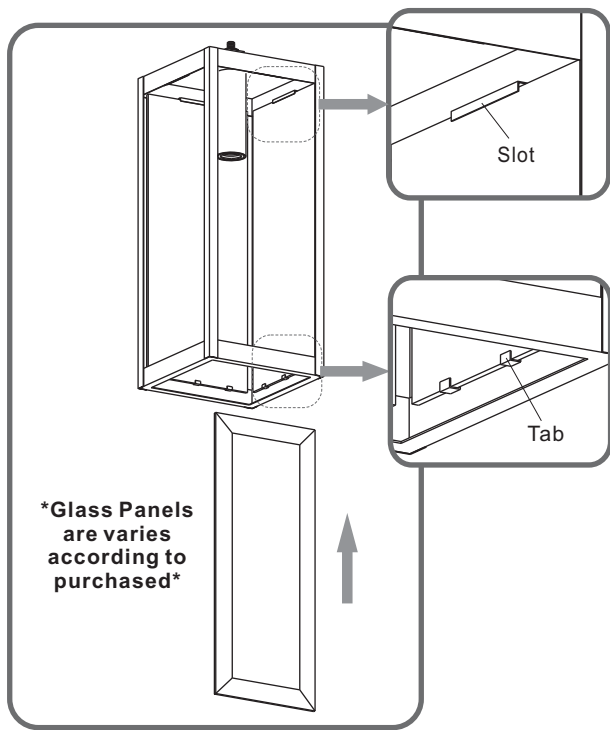

STEP 2

1

Step 1
Install crossbar assembly

2

Step 2 - 3
Test fitting ceiling canopy to nipple

3

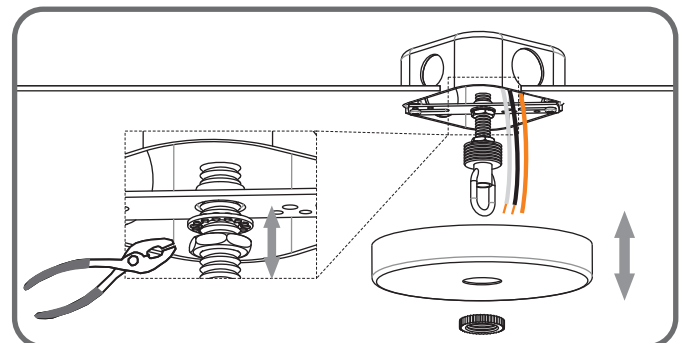
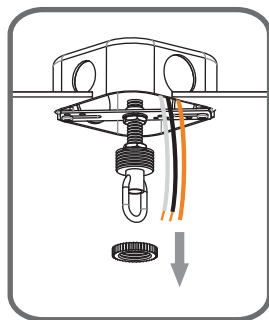
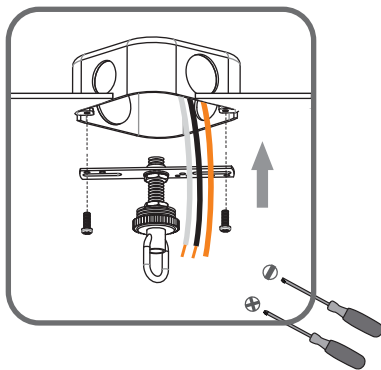

STEP 3

1

Step 1
Adjust fixture chain length

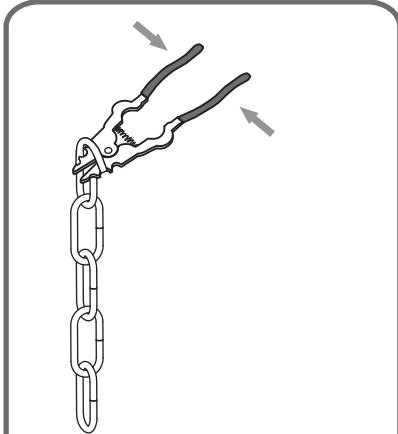

Suggested Chain Length:

- 8' ceiling: 4.25" Chain
- 9' ceiling: 15.25" Chain
- 10' ceiling: 26.25" Chain

2

Step 2 - 3
Install Fixture Chain

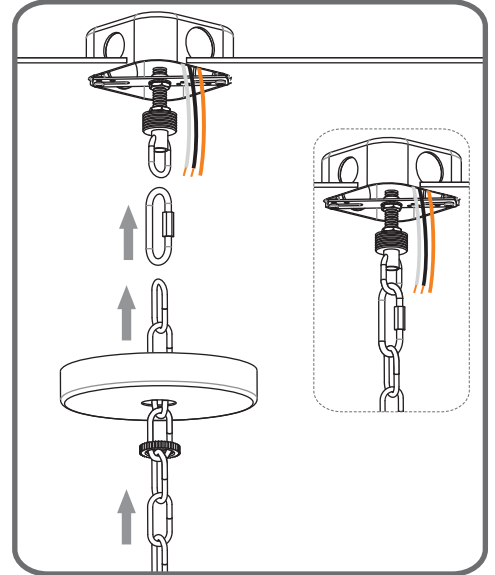
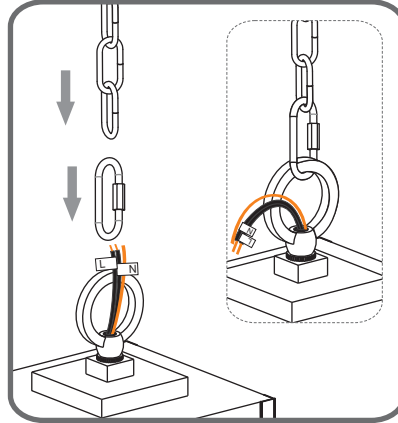

STEP 4

1

Step 1
Feed the fixture wires
through the loop

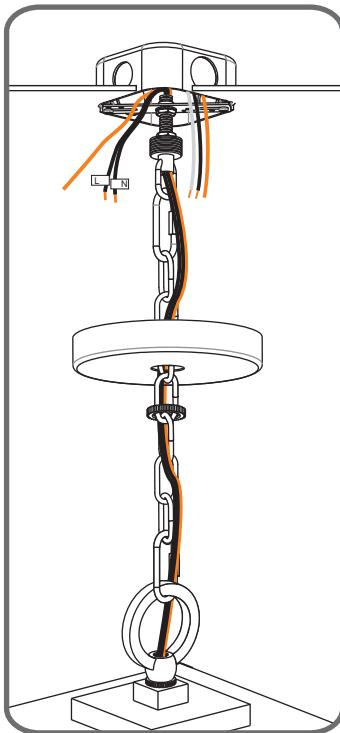

2

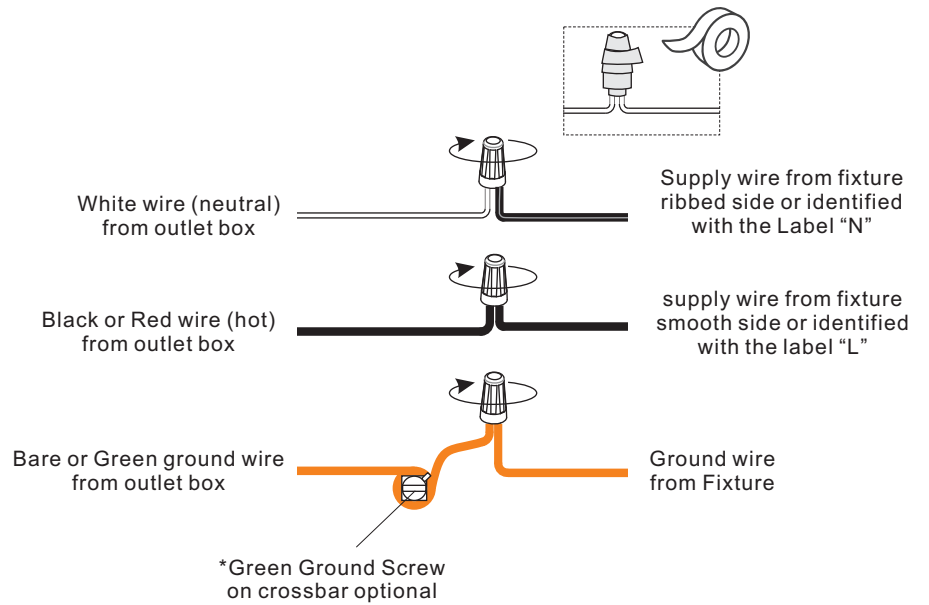

STEP 5

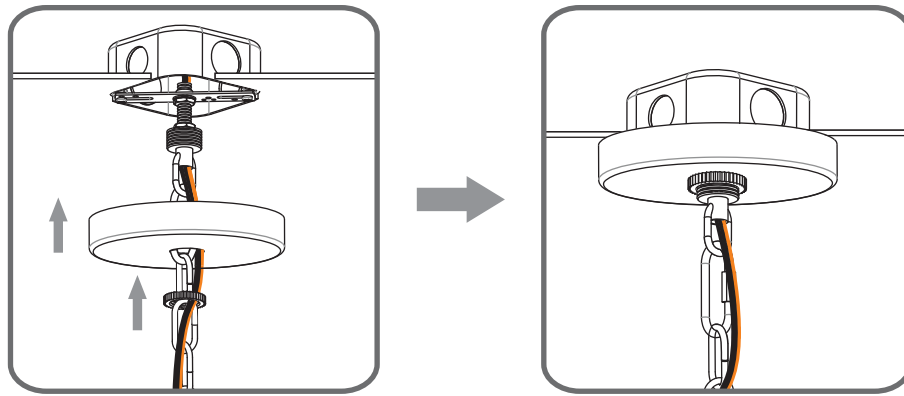

STEP 6

