

Tools Required: Flathead screwdriver, Phillips screwdriver, pliers, wire cutters, wire strippers, electrical tape, safety glasses.

Light Source: (1) A19 Medium Base bulb 100W Maximum, Alternate bulb (1) 23W CFL.

Estimated Assembly Time: 20-30 minutes

Preparation: Identify and inspect all parts before beginning installation. Check package content list and diagrams below to be sure all parts are present. If any parts are missing or damaged, do not attempt to assemble, install, or operate the fixture. Contact customer service for replacement parts.

Fixture can only be mounted in the direction indicated on page 2.

⚠ Warnings and Cautions

Turn off electricity at circuit breaker or main fuse box before installation. Consult a licensed electrician if in doubt.

These instructions are provided for your safety. It is very important you read them completely before installing the fixture. We strongly recommend that a licensed, professional electrician perform the installation.

Disconnect fixture from power source before replacing bulbs. Make sure bulbs are given sufficient time to cool before removal. Do not subject glass parts to any shock while in operation or shattering may result.

Package Contents

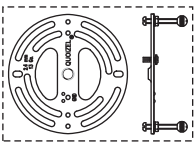

A Crossbar Assembly x 1

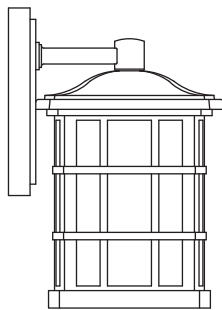

B Fixture Body x 1

STEP 1 - Install Crossbar Assembly

A. Pass the supply wires through the Crossbar Assembly (A). Attach the Crossbar Assembly (A) to the Outlet Box with the head of the Green Ground Screw facing you. Secure it with Outlet Box Screws (not included). Tighten until snug.

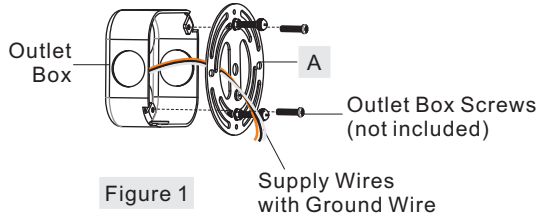

Figure 1

Supply Wires with Ground Wire

STEP 2 - Fit Backplate to Crossbar Assembly

A. Remove mounting balls from the Crossbar Assembly (A). Fit the backplate on Fixture Body (B) to the Crossbar Assembly (A) and secure with mounting balls. Note: The backplate on Fixture Body (B) should be snug against the wall and the mounting balls. If not, adjust the length of the mounting screw on the Crossbar Assembly (A) by unscrewing the preassembled hex nut and lock washer and then screwing the mounting screws in or out of the crossbar until the correct length is achieved. Once the backplate on Fixture Body (B) is secure, remove the mounting ball and Fixture Body (B) and proceed to Step 3.

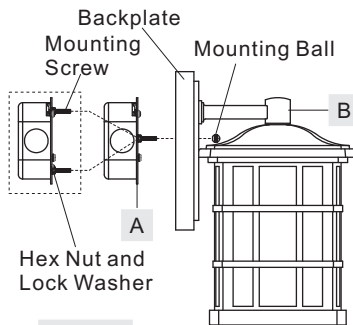

Figure 2

STEP 3 - Wire Connections

A. Use standard wire connectors (not included) to make all wire connections. (Connectors are not included with fixture.) Twist connectors until wires are tightly joined together. Wrap each connection with approved electrical tape and carefully stuff all the connected wires into the Outlet Box.

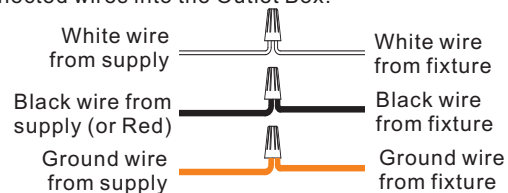

Figure 3

STEP 4 - Install Fixture Body

A. Carefully tuck all wires into the outlet box and position the backplate of Fixture Body (B) over the outlet box. Align the holes in the backplate with the mounting screws. Place caulk (not supplied) into the previously removed mounting balls and then attach Fixture Body (B) using the mounting balls. Hand tighten until snug.

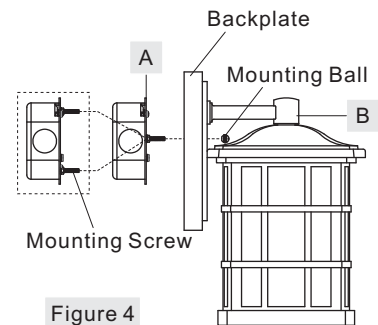

Figure 4

STEP 5 - Install Bulb and Apply Silicone Sealer

A. This fixture uses standard bulb with medium base. Maximum 100 watts. Insert bulb and screw snugly into place.
B. Make sure exterior wall surface and fixture backplate are free of dirt before applying caulk. Using exterior grade caulk, caulk over top of backplate and down other side. Do not caulk bottom of fixture backplate to ensure proper moisture drainage.

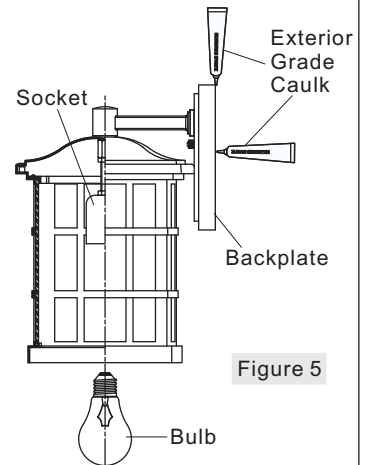

Figure 5

Your fixture is now assembled and ready to use. Enjoy!

HOW TO REPLACE GLASS PANELS

SKU: UQL1232

- A. By unscrewing Allen Screws, remove the Cage from the Fixture Hood.
- B. Unscrew Screws on the top of the Cage. Remove the Glass Holder from the Cage. Remove the broken Glass Panel inside of the Cage and insert the replacement Glass Panel.
- C. Place the Glass Holder back onto the top of the Cage and secure with Screws. Hand tighten until snug.
- D. Attach the Cage with Glass Panels back onto the Fixture Hood and secure with Allen Screws. Hand tighten until snug.

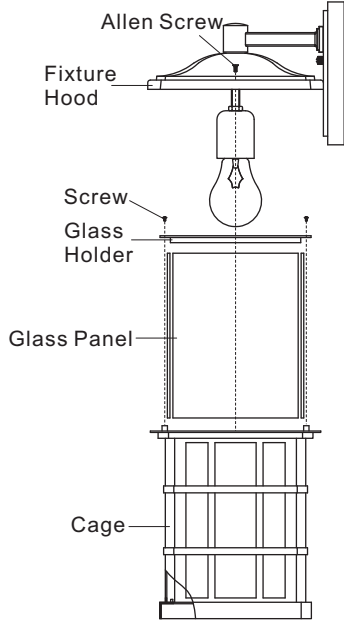
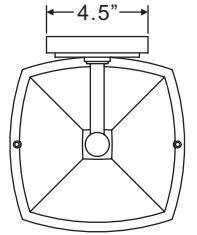
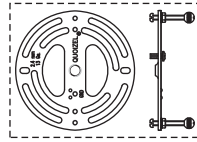
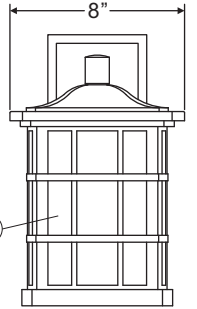
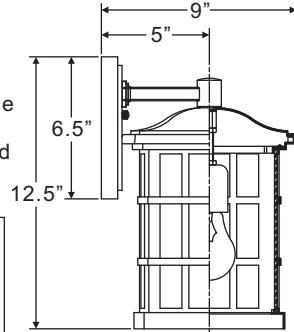

Figure 6



↑
Fixture can only be mounted in the direction indicated



NOTE: ALL DIMENSIONS ARE ROUNDED UP TO THE NEAREST 1/4"

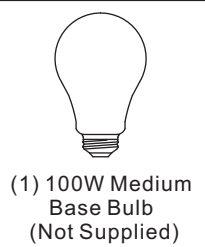

NO.	PART NUMBER	REPLACEMENT PART	REQ.
1	UQL1232PA	GLASS PANEL	4