

urban ambiance

UQL1090

EXTERIOR WALL SCONCE

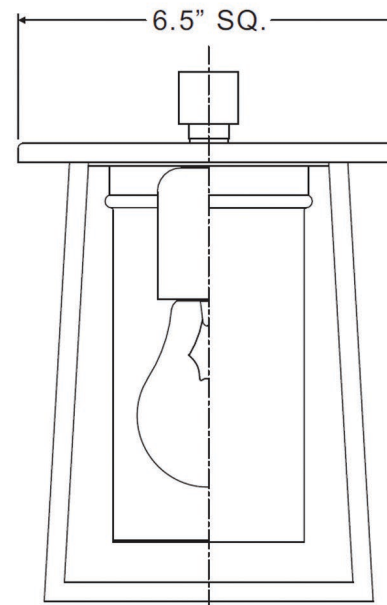
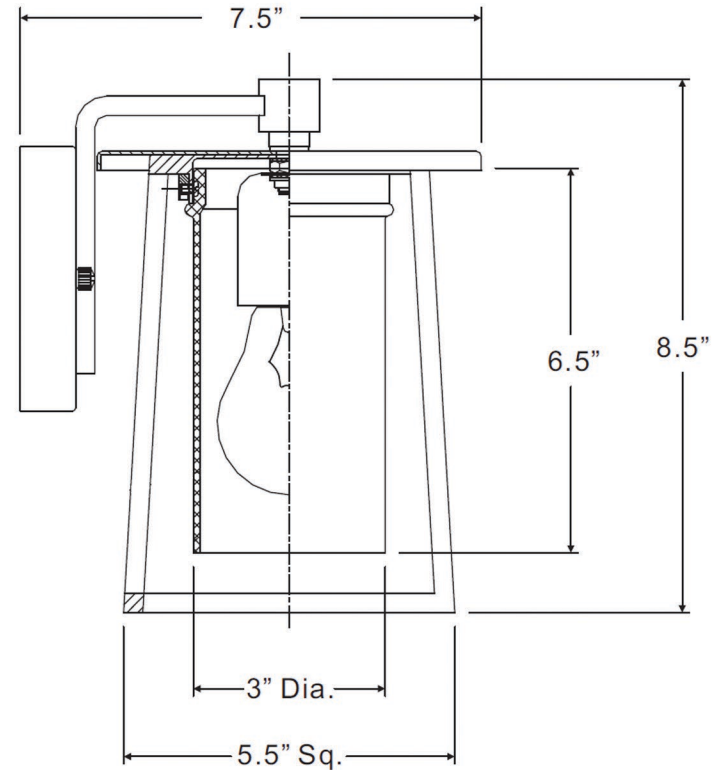

Collection	Lisbon
Finish	Black Silk
Shade	Clear Hammered Glass
Bulb Type	A19 Medium Base
Bulb Wattage	100
Number of Bulbs	1
Bulbs Included	No
Certification	ETL Listed
Rated For	Wet
Weight	3 Pounds
Chain Length	N/A
Extension Rods	N/A
Material Construction	Aluminum