

INSTALLATION AND SAFETY INSTRUCTION FOR WALL FIXTURE

CAUTION! SHUT POWER OFF AT MAIN CIRCUIT BREAKER BEFORE INSTALLATION.

MOUNTING THE FIXTURE(FIG.1)

JUST FOR REFERENCE

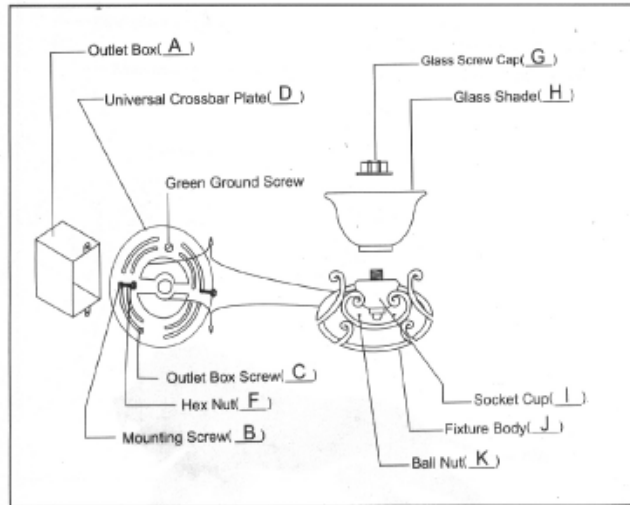

1. Turn electricity off at main circuit breaker. Remove the new fixture and mounting parts from the box and make sure that no parts are missing before installation.
 2. Mounting Screws(B) should be threaded through the back of two mounting screw holes on Universal Crossbar(D) then lock into place with Hex Nut(F).
 3. Fasten the Universal Crossbar(D) to the Outlet Box(A) with(Two) Outlet Box Screws(Shown as C. Not Furnished) & "GND" on side of Crossbar (D) should be faced out.
 4. Connect the wires as wiring instruction (See Wiring Diagram)
 5. Secure the Fixture(J) to the Outlet Box(A). Mounting Screws(B) on Universal Crossbar(D) will go through the mounting screw holes on the fixture, then tighten the Ball Nuts(K) to secure the fixture against the wall.
 6. Secure the Glass Shade(H) by placing onto Socket Cup(I) and threading Glass Screw Cap(G) until glass is snug.
 7. Install the Bulbs (Caution: Please refer to the fixture's specifications. Do not exceed the maximum wattage for fixture.
 8. Turn electricity back on at main circuit breaker
- Note: Some bath bars mount in one direction only please check back of Fixture for directional arrow, if none fixture can hang either way.

CONNECTING THE WIRE (See Wiring Diagram)

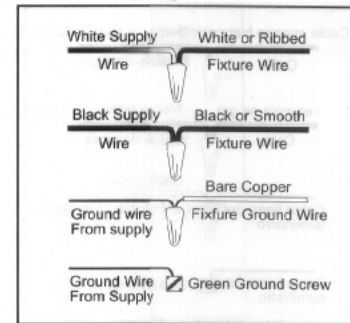

1. Connect your grounding wire (Green or Bare copper) from Fixture to grounding wire on outlet box or to the green ground screw on the crossbar.
2. Connect the House White Wire to the Fixture White Supply Wire; connect House Black (or Red) Wire to the Fixture Black Supply Wire.
3. Make sure no bare wires can be seen outside of the wire connector.
4. Tuck the wires into outlet box carefully.

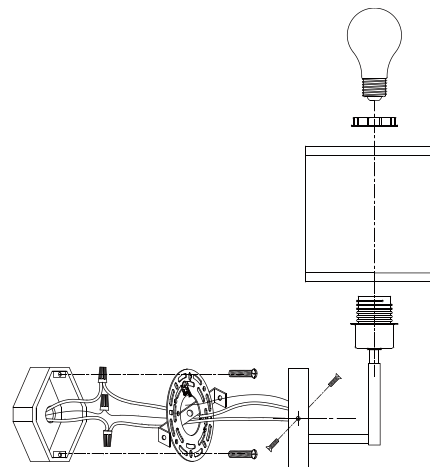

urban ambiance

SKU: ULB2142

