

INSTALLATION AND SAFETY INSTRUCTION FOR MINI PENDANT

CAUTION! SHUT POWER OFF AT MAIN CIRCUIT BREAKER BEFORE INSTALLATION.

MOUNTING THE FIXTURE(FIG.1)

JUST FOR REFERENCE

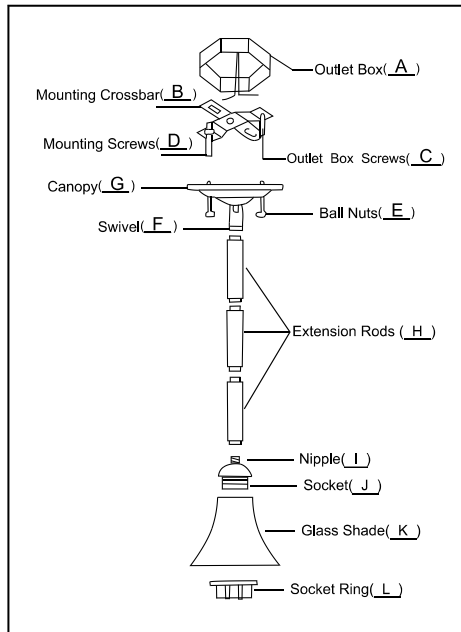

1. Turn electricity off at main circuit breaker.
2. Assemble the fixture: Thread the Extension Rods(H) together. Screw the bottom end of the Extension Rods(H) onto Nipple(I) until snug. Thread the top end of Extension Rod(H) into the Swivel(F) tighten screw on Swivel(F).
3. Put Glass Shade(K) over Socket(J) and secure with Socket Ring(L) until snug.
4. Mounting the fixture: Mounting Screws(D) should be threaded through the back of two mounting screw holes on Mounting Crossbar(B).
5. Fasten Mounting Crossbar(B) to the Outlet Box(A) with two Outlet Box Screws(Shown as C. Not Furnished) & "GND on side of Crossbar(B) should be faced out.
6. Connect the wires as wiring instructions (See Wiring Diagram).
7. Push the Canopy(G) over the Outlet Box(A), Mounting Screws(D) will protrude through the mounting holes on Canopy(G), then secure with Ball Nuts(E) until snug.
8. Install the Bulbs (Caution: Please refer to the fixture's specifications. Do not exceed the maximum wattage for fixture.)
9. Turn electricity back on at the main circuit breaker.

CONNECTING THE WIRE (See Wiring Diagram)

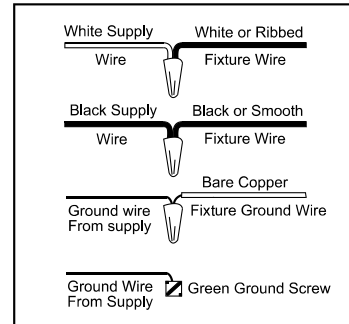

1. Connect your grounding wire (Green or Bare copper) from Fixture to grounding wire on outlet box or to the green ground screw on the crossbar.
2. Connect the House White Wire to the fixture White Supply Wire: connect House Black (or Red) Wire to the Fixture Black Supply Wire.
3. Make sure no bare wires can be seen outside of the wire connector.
4. Tuck the wires into outlet box carefully.

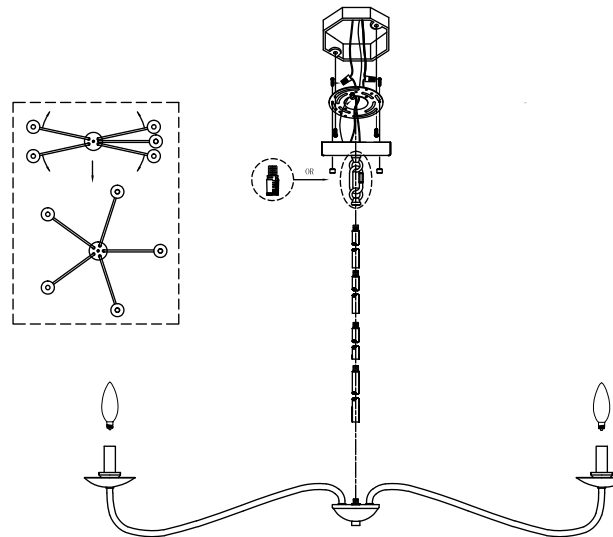

urban ambiance

SKU: ULB2061

