

urban ambiance

Installation Instructions: **UHP4351**

PART	DESCRIPTION	QUANTITY
A	Bottom wire frame	1
B	Canopy	1
C	Plastic buckle	1
D	Knurled tube	1
E	Top wire frame	1
F	Collar	1

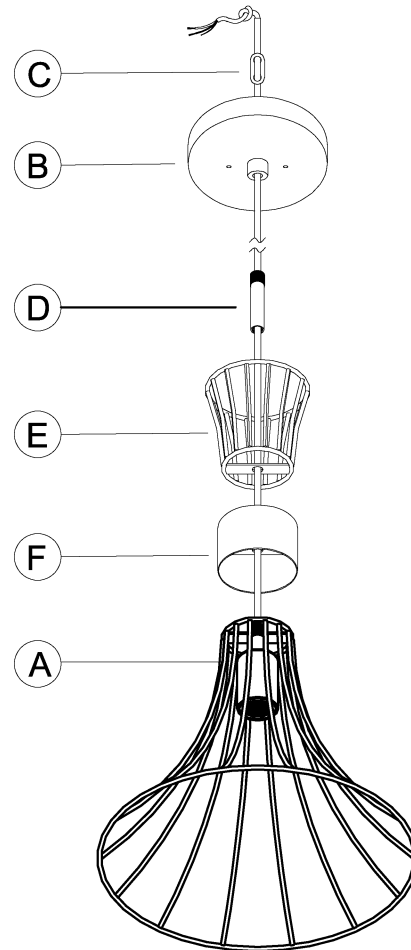

HARDWARE CONTENTS (not actual size)

AA	BB	CC	DD	EE
Screw (#8-32) Qty:2	Wire Nut Qty:3	Mounting Strap Qty:1	Hex Nut (#8-32) Qty:2	CylinderNut (#8-32) Qty:2



Questions?

Call our Customer Care Team at 1-855-303-4229

urban ambiance

www.urbanambiance.com



Safety Information

Please read and understand this entire manual before attempting to assemble, operate or install the product.

CAUTION: Read instructions carefully and turn electricity off at main circuit breaker panel before beginning installation.

CAUTION: Risk of fire. Min. 90°C supply conductors. Consult a qualified electrician to ensure correct branch circuit conductor.

WARNING: If any Special Control Devices are used with this fixture, follow instructions carefully to assure full compliance with N.E.C. requirements. If there are any questions, contact a qualified electrical contractor.

CAUTION: All glass is fragile. Use care when handling glass shades and bulbs.

Preparation

1. Before beginning installation, make sure all parts are included using the contents diagrams from page 1. If any part is missing or damaged, do not attempt to assemble, install or operate the product.
2. Estimated assembly time: 30 minutes.
3. Tools required for assembly (not included): Phillips screwdriver, pliers, wire stripper, safety glasses, electrical tape, ladder.

Care and Maintenance

Shut off main power supply before cleaning product or changing light bulbs. To clean, wipe with damp cloth. Do not use abrasive cleaners or cleaners that contain alcohol.

Assembly Instructions

1

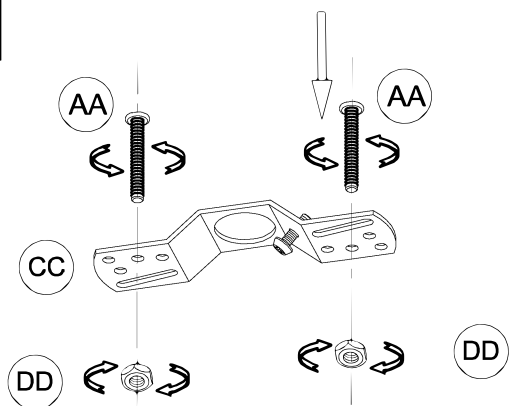

1. Loosely thread the screws (AA) and the hex nuts (DD) onto the swivel mounting strap (CC) as shown. You now need to adjust the screw length according to the fixture canopy depth.

2. With the swivel bracket facing down, attach this assembly to the outlet box using the mounting screws supplied with the outlet box (not provided). Tighten securely.

Lift up the canopy (B) and pass the screws (AA) through the two mounting holes in the canopy. While holding the canopy with one hand, thread the screws (AA) in or out of the swivel mounting strap (CC) until 3/16" of threads are showing. That should be enough to mount the fixture as instructed in step 4.

Next, take the canopy down and go back and tighten the hex nuts (DD) up against the mounting strap (CC). You now should have the correct length of threads for mounting the fixture.

2

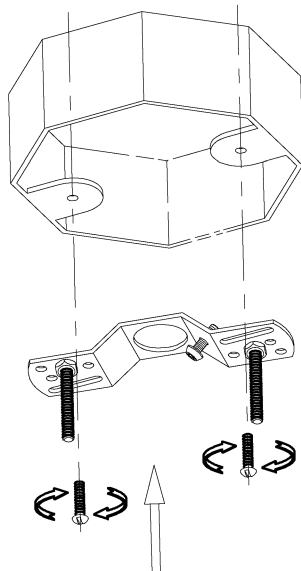

INCORRECT

CORRECT

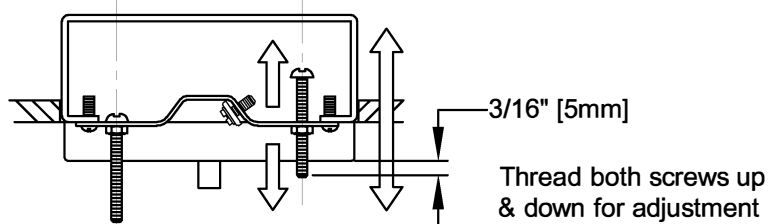

3/16" [5mm]

Thread both screws up & down for adjustment

Assembly Instructions

3

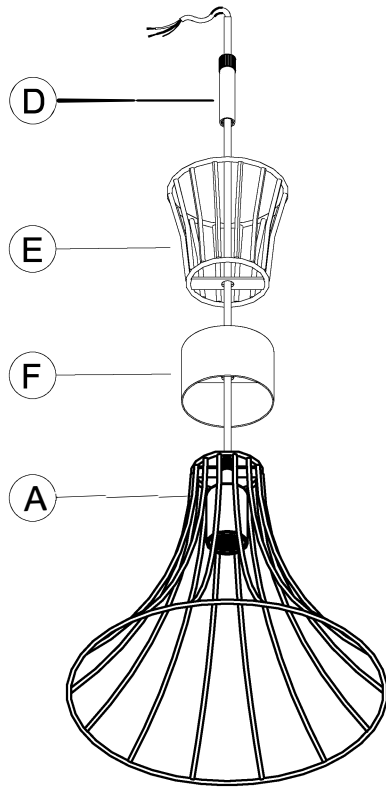

3. Pass the cord from the bottom wire frame (A) through the collar (F) and top wire frame (E) and knurled tube (D). Thread the knurled tube (D) onto the bottom wire frame (A). Tighten the parts securely together (A,F,E) with the knurled tube (D).

4

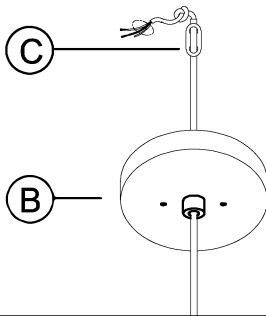

NOTE: During this step, determine the hanging length of your fixture by adjusting the cord length.

Do NOT cut electrical or ground wires until this length is determined. Leave **AT LEAST 6 inches MINIMUM** of wire past the canopy to allow for easy connections in step 5.

4. Once hanging length is determined, pass the cord through the canopy (B) and the plastic buckle (C). Then tie a UL knot at the end of wire.

5

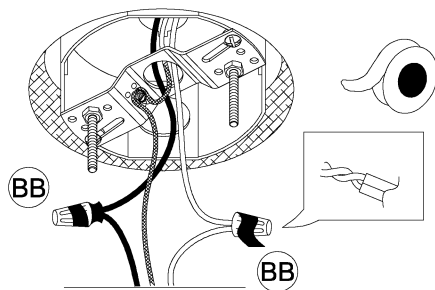

5. Strip $\frac{3}{8}$ " of insulation from the electrical wire ends. Using wire nuts (BB), connect **WHITE** fixture wire to the **WHITE** supply wire from the outlet box; connect the **BLACK** fixture wire to the **BLACK** supply wire.

Connect the fixture ground wire and supply ground wire using a wire nut or by fastening to the ground screw on the round mounting plate. Push all wire connections into the outlet box.

Assembly Instructions

6

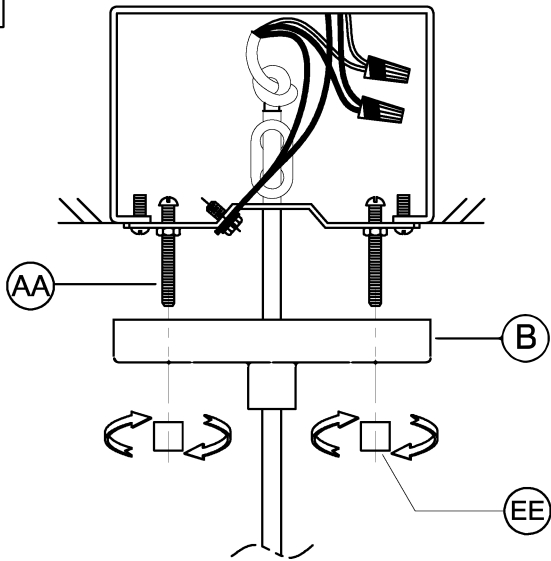

6. Pass the screws (BB) through the two holes in the canopy (B). Secure the fixture (A) to the screws (AA) using the two cylinder nuts (EE). Tighten securely.

7

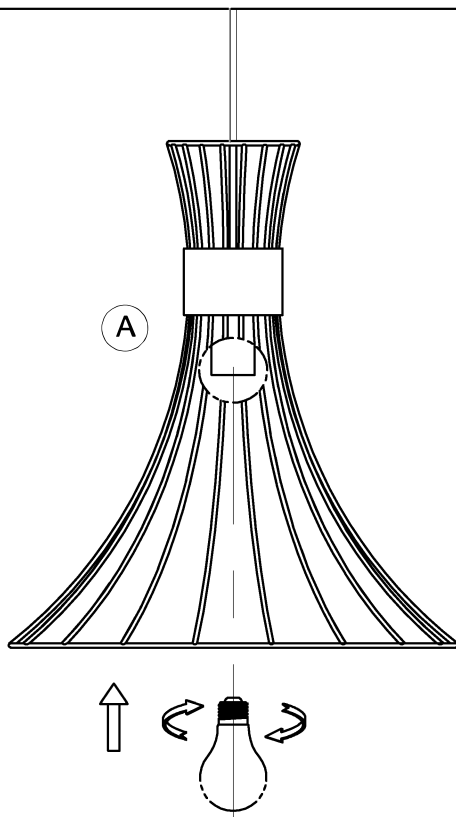

7. Thread the lamp (not included) into the fixture socket. Use 60-watt MAX incandescent medium base lamp, SBCFL or SBLED.



Questions?

Call our Customer Care Team at 1-855-303-4229

urban ambiance

www.urbanambiance.com