

urban ambiance

Installation Instructions: **UHP4344**

PART	DESCRIPTION	QUANTITY
A	Fixture	1
B	Glass Shade	1
C	Socket Ring	1

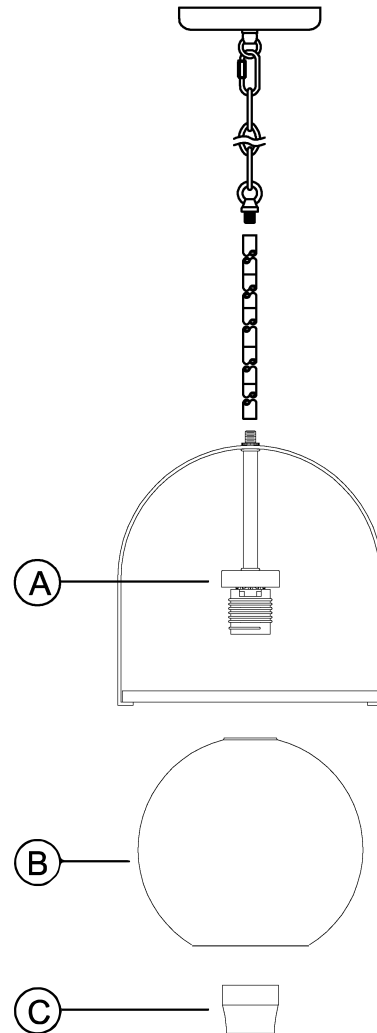
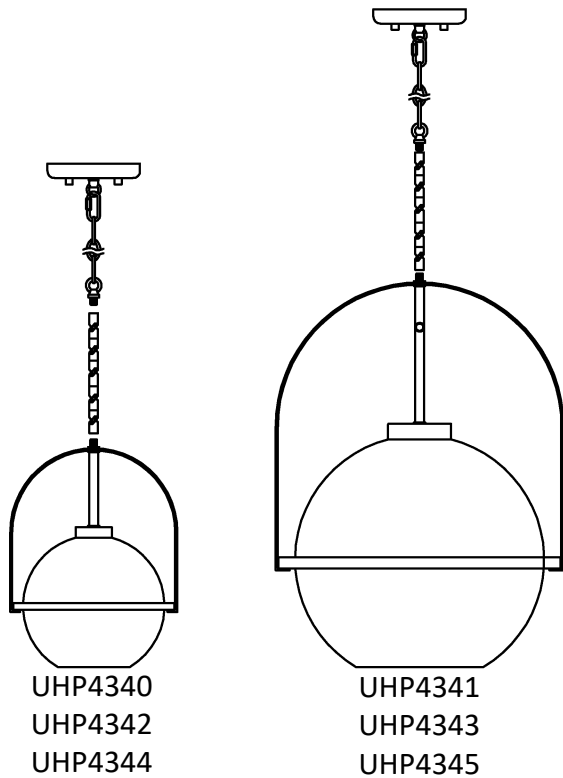

HARDWARE CONTENTS (not actual size)

AA	BB	CC	DD	EE	FF	GG	HH	JJ	KK	LL
Screw (#8-32) Qty:2	Wire Nut Qty:3	Round Mounting Plate Qty:1	Hex Nut (#8-32) Qty:2	Cylinder Nut (#8-32) Qty:2	Chain (6 links) Qty:1	Chain Loop (1/8IP) Qty:2	12" Pipe (1/8IP) Qty:4	6" Pipe (1/8IP) Qty:1	Nipple (1/8IP) Qty:5	Quick link Qty:1



Questions?

Call our Customer Care Team at 1-855-303-4229

urban ambiance

www.urbanambiance.com



Safety Information

Please read and understand this entire manual before attempting to assemble, operate or install the product.

CAUTION: Read instructions carefully and turn electricity off at main circuit breaker panel before beginning installation.

CAUTION: Risk of fire. Min. 90°C supply conductors. Consult a qualified electrician to ensure correct branch circuit conductor.

WARNING: If any Special Control Devices are used with this fixture, follow instructions carefully to assure full compliance with N.E.C. requirements. If there are any questions, contact a qualified electrical contractor.

CAUTION: All glass is fragile. Use care when handling glass shades and bulbs.

Preparation

1. Before beginning installation, make sure all parts are included using the contents diagrams from page 1. If any part is missing or damaged, do not attempt to assemble, install or operate the product.
2. Estimated assembly time: 30 minutes.
3. Tools required for assembly (not included): Phillips screwdriver, pliers, wire stripper, safety glasses, electrical tape, ladder.

Care and Maintenance

Shut off main power supply before cleaning product or changing light bulbs. To clean, wipe with damp cloth. Do not use abrasive cleaners or cleaners that contain alcohol.

Assembly Instructions

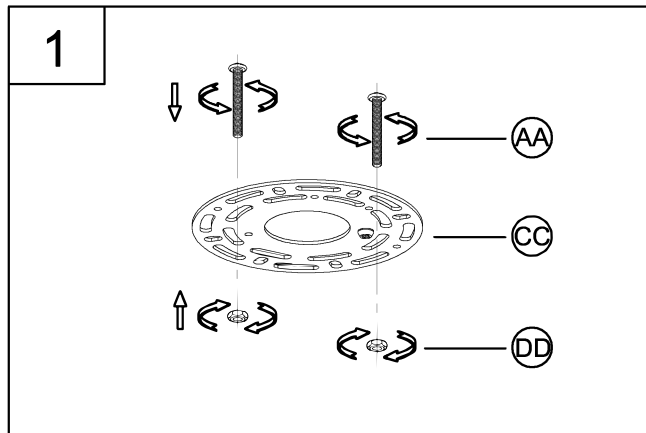

1. Loosely thread the screws (AA) and the hex nuts (DD) onto the round mounting plate (CC) as shown. You now need to adjust the screw length according to the fixture canopy depth.

2. Attach this assembly to the outlet box using the mounting screws supplied with the outlet box (not provided). Tighten securely.

Lift up the fixture and pass the screws (AA) through the two mounting hole in the fixture canopy. While holding the fixture with one hand, thread the screws (AA) in or out of the round mounting plate (CC) until 3/16" of threads are showing. That should be enough to mount the fixture as instructed in step 4.

Next, take the fixture down and go back and tighten the hex nuts (DD) up against the mounting strap (CC). You now should have the correct length of threads for mounting the fixture.

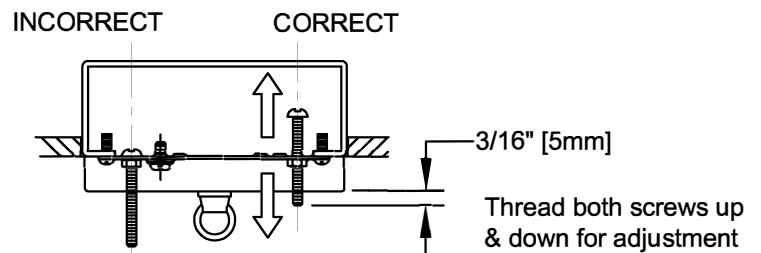
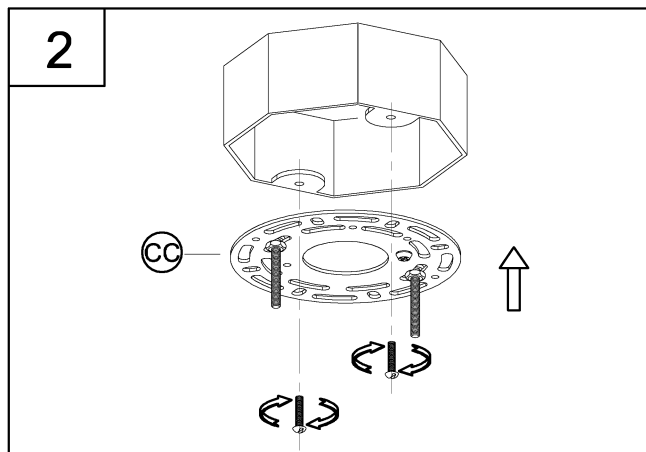

Assembly Instructions

3

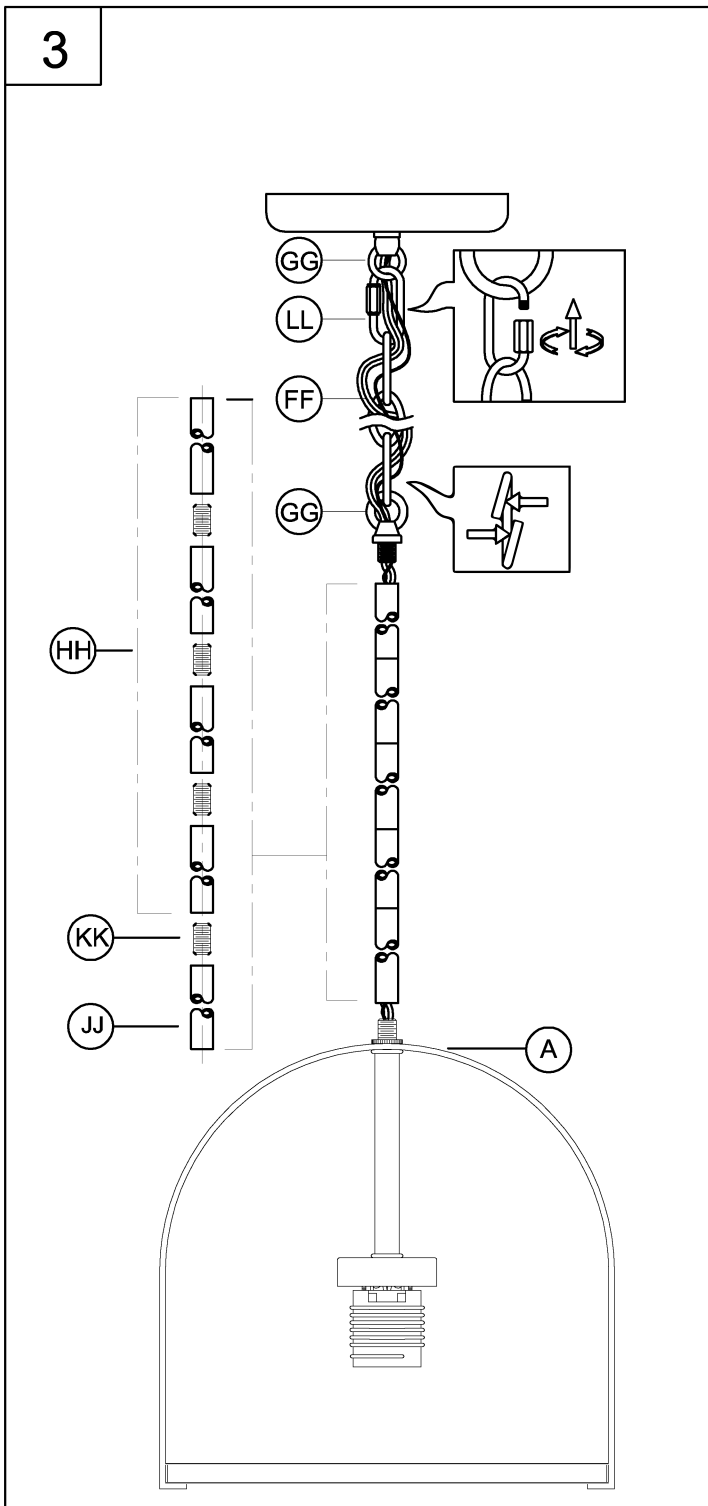

NOTE: During this step, determine the hanging length of your fixture by adding or removing stems and chain links. The electrical and ground wire may also optionally be cut to length.

Do NOT cut electrical or ground wires until this length is determined. Leave **AT LEAST 6 inches MINIMUM** of wire past the canopy chain loop (GG) to allow for easy connections in step 4.

(Chain links can be spread open with 2 pairs of pliers. Twist the split link ends in opposite directions and close by squeezing them back together.)

3. Once hanging length is determined, pass wires through stems (HH/JJ) and nipples (KK), tightening stems to assembly as you go to avoid twisting the wires. Pass wires through chain loop (GG) and tighten chain loop (GG) to stem assembly (HH). Then tighten the stem assembly onto fixture (A).

Open chain link at one end of chain (FF). Hook an open chain links onto the loop (GG) on top of the stem assembly (HH). Close the chain links back together with the pliers. Hook the other end of chain (FF) to the canopy loop (GG) using the quick link (LL). Continue to pass the wires through every other chain link (FF) and up through the canopy loop (GG).



Questions?

Call our Customer Care Team at 1-855-303-4229

urban ambiance
www.urbanambiance.com

Assembly Instructions

4

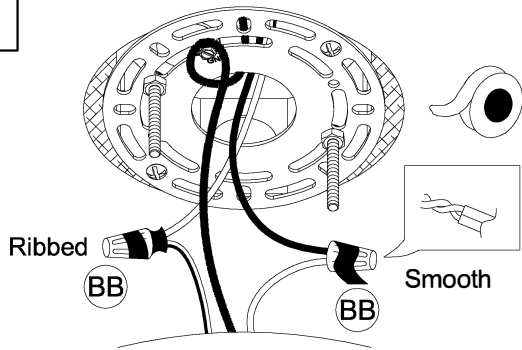

4. Strip 3/8" of insulation from the electrical wire ends. Using wire nuts (BB), connect RIBBED fixture wire to the WHITE supply wire from the outlet box; connect the SMOOTH fixture wire to the BLACK supply wire.

Connect the fixture ground wire and supply ground wire using a wire nut or by fastening to the ground screw on the round mounting plate. Push all wire connections into the outlet box.

5

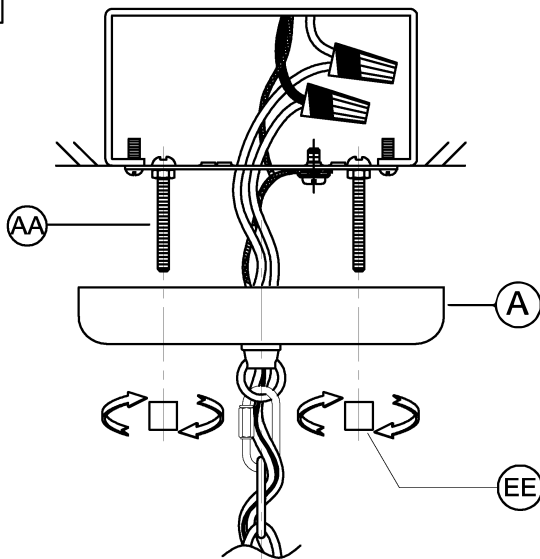

5. Pass the screws through the two holes in the canopy. Secure the fixture (A) to the screws (AA) using the two cylinder nuts (EE). Tighten securely.

6

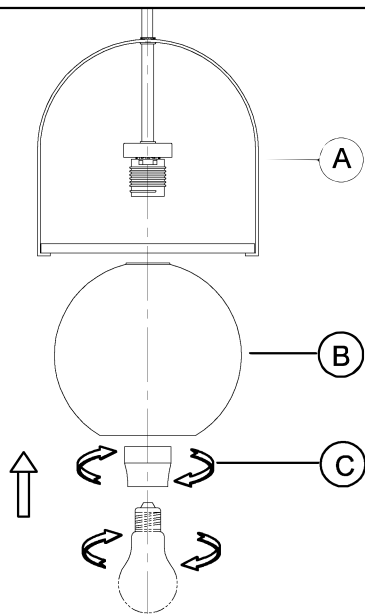

6. Attach the glass shade (B) to the fixture (A) using the socket ring (C) to secure it tightly.

Thread the lamp (not included) into the fixture socket. Use 100-watt MAX incandescent medium base lamp, SBCFL or SBLED.