

# urban ambiance

Installation Instructions: **UHP4328**

	PART DESCRIPTION	QUANTITY			
		1-LIGHT	2-LIGHT	3-LIGHT	4-LIGHT
A	Fixture	1	1	1	1
B	Glass shade	1	2	3	4
C	Socket cover	1	2	3	4
D	Socket ring	1	2	3	4

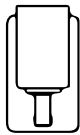
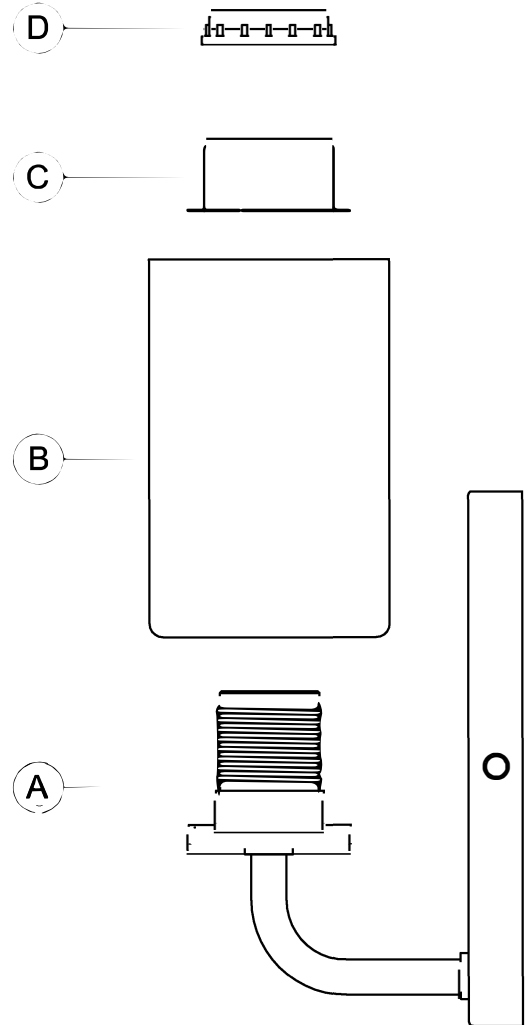

UHP4320  
UHP4324  
UHP4328

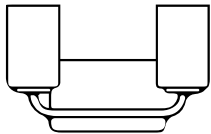

UHP4321  
UHP4325  
UHP4329

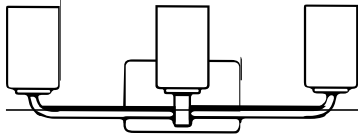



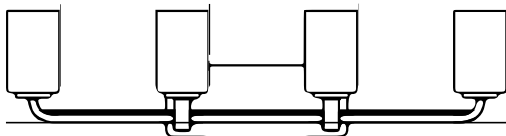

UHP4322  
UHP4326  
UHP4330

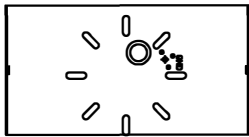

UHP4323  
UHP4327  
UHP4331

## HARDWARE CONTENTS (not actual size)

BB	CC	DD	EE	FF	
					
Wire Nut	Metal Back Plate	Screw (#8-32)	Anchor screws	Plastic anchors	
Qty:3	Qty:1	Qty:4	Qty:2	Qty:2	



### Questions?

Call our Customer Care Team at 1-855-303-4229

urban ambiance

[www.urbanambiance.com](http://www.urbanambiance.com)



## Safety Information

Please read and understand this entire manual before attempting to assemble, operate or install the product.

**CAUTION:** Read instructions carefully and turn electricity off at main circuit breaker panel before beginning installation.

**CAUTION:** Risk of fire. Min. 90°C supply conductors. Consult a qualified electrician to ensure correct branch circuit conductor.

**WARNING:** If any Special Control Devices are used with this fixture, follow instructions carefully to assure full compliance with N.E.C. requirements. If there are any questions, contact a qualified electrical contractor.

**CAUTION:** All glass is fragile. Use care when handling glass shades and bulbs.

## Preparation

1. Before beginning installation, make sure all parts are included using the contents diagrams from page 1. If any part is missing or damaged, do not attempt to assemble, install or operate the product.
2. Estimated assembly time: 30 minutes.
3. Tools required for assembly (not included): Phillips screwdriver, pliers, wire stripper, safety glasses, electrical tape, ladder.

## Care and Maintenance

Shut off main power supply before cleaning product or changing light bulbs. To clean, wipe with damp cloth. Do not use abrasive cleaners or cleaners that contain alcohol.

## Assembly Instructions

1a

P300368 P300369 P300370

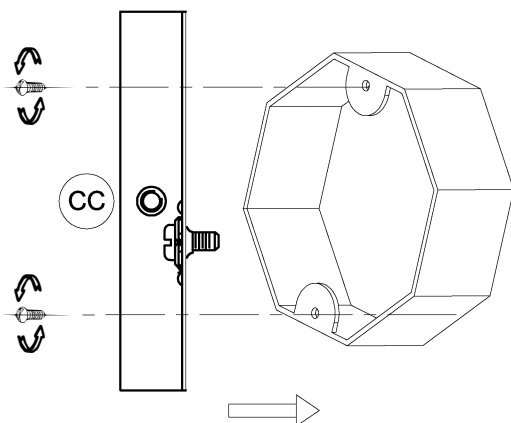

- 1a. Attach the metal back plate (CC) onto the outlet box using the mounting screws supplied with the outlet box (not provided). Adjust it so it is parallel with the ceiling or wall surface. Tighten securely.

1b

P300371

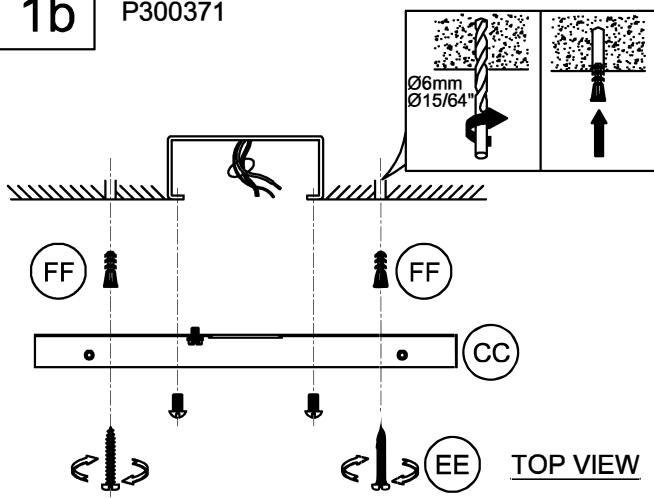

- 1b. Line up mounting holes on the back plate (CC) with screw holes on the outlet box. Using the back plate (CC) as a template, locate the mounting slots on the outer edges of the back plate (CC). Drill pilot holes for the Plastic anchors (FF). Remove back plate from the outlet box.

Press the Plastic anchors (FF) into the pilot holes. Install the back plate (CC) to the outlet box using the mounting screws (not provided).

Once back plate (CC) is installed, drive the provided Anchor screws (EE) into the installed Plastic anchors (FF).

# Assembly Instructions

2. Strip 3/8" of insulation from the electrical wire ends. Using wire nuts (BB), connect the WHITE fixture wire to the WHITE supply wire from the outlet box; connect the BLACK fixture wire to the BLACK supply wire from the outlet box.

Connect the fixture ground wire and supply ground wire using a wire nut or by fastening it to the ground screw on the metal back plate. Push all of the wire connections carefully into the outlet box.

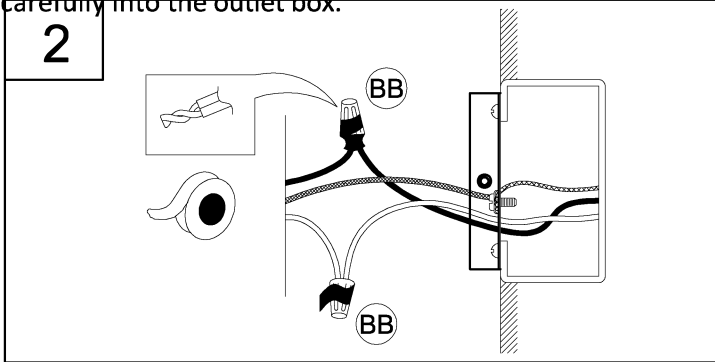

3. Attach the fixture (A) to the metal back plate using the screws provided (DD).

Tighten the fixture against the mounting surface.

Fixture can mount in glass UP or glass DOWN position.

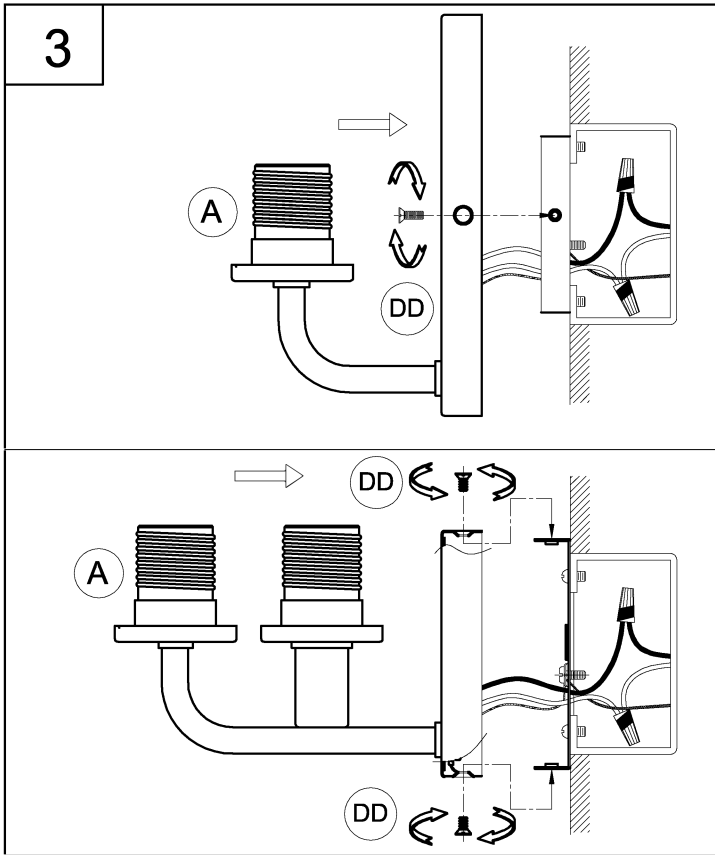

4. Attach the glass shade (B) and socket cover (C) to the fixture (A). Use the socket rings (D) to secure modestly tight.

Thread the lamps (not included) into the fixture sockets. Use 100-watt MAX incandescent medium base lamp, SBCFL or SBLED.

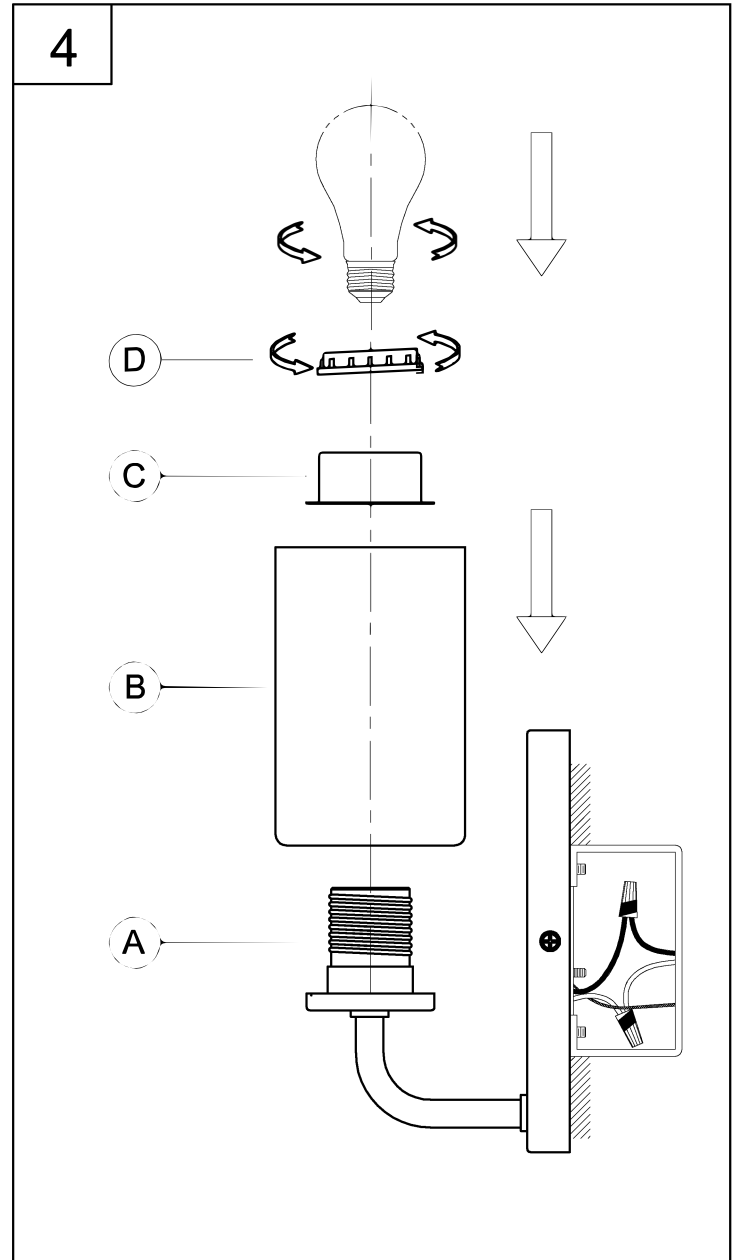

## Questions?

Call our Customer Care Team at 1-855-303-4229

urban ambiance

[www.urbanambiance.com](http://www.urbanambiance.com)