

urban ambiance

Installation Instructions: **UHP4303**

PART	DESCRIPTION	QUANTITY			
		1-LIGHT	2-LIGHT	3-LIGHT	4-LIGHT
A	Fixture	1	1	1	1
B	Glass shade	1	2	3	4
C	Socket ring	1	2	3	4

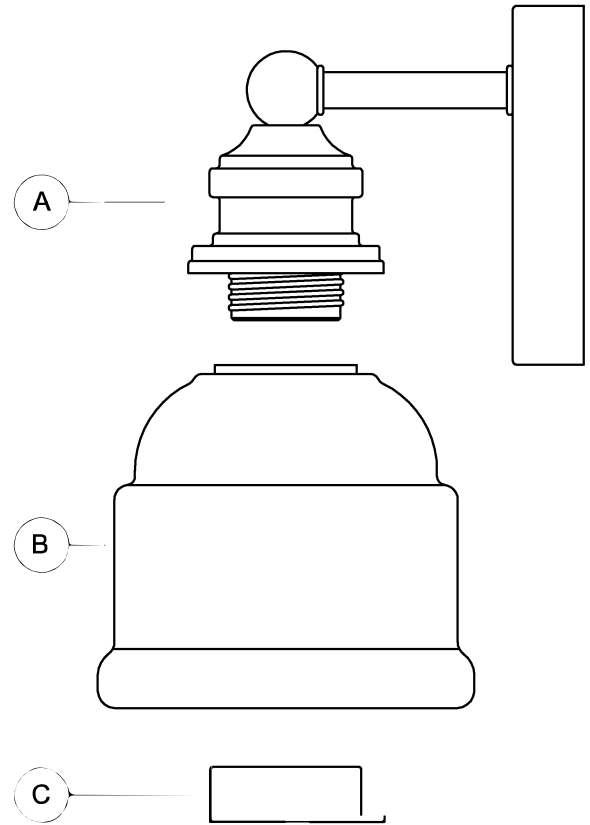
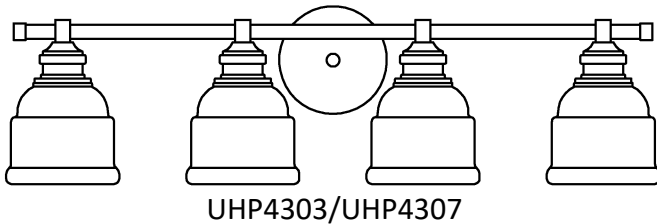
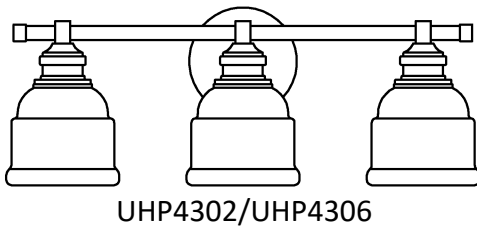
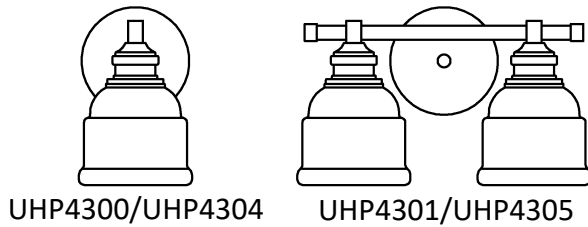

HARDWARE CONTENTS (not actual size)

Nipple (1/8IP)	Wire Nut	Mounting Strap (1/8IP)	Hex Nut (1/8IP)	Lock washer	Finial (1/8IP)
Qty:1	Qty:3	Qty:1	Qty:1	Qty:1	Qty:1



Questions?

Call our Customer Care Team at 1-855-303-4229

urban ambiance

www.urbanambiance.com



Safety Information

Please read and understand this entire manual before attempting to assemble, operate or install the product.

CAUTION: Read instructions carefully and turn electricity off at main circuit breaker panel before beginning installation.

CAUTION: Risk of fire. Min. 90°C supply conductors. Consult a qualified electrician to ensure correct branch circuit conductor.

WARNING: If any Special Control Devices are used with this fixture, follow instructions carefully to assure full compliance with N.E.C. requirements. If there are any questions, contact a qualified electrical contractor.

CAUTION: All glass is fragile. Use care when handling glass shades and bulbs.

Preparation

1. Before beginning installation, make sure all parts are included using the contents diagrams from page 1. If any part is missing or damaged, do not attempt to assemble, install or operate the product.
2. Estimated assembly time: 30 minutes.
3. Tools required for assembly (not included): Phillips screwdriver, pliers, wire stripper, safety glasses, electrical tape, ladder.

Care and Maintenance

Shut off main power supply before cleaning product or changing light bulbs. To clean, wipe with damp cloth. Do not use abrasive cleaners or cleaners that contain alcohol.

Assembly Instructions

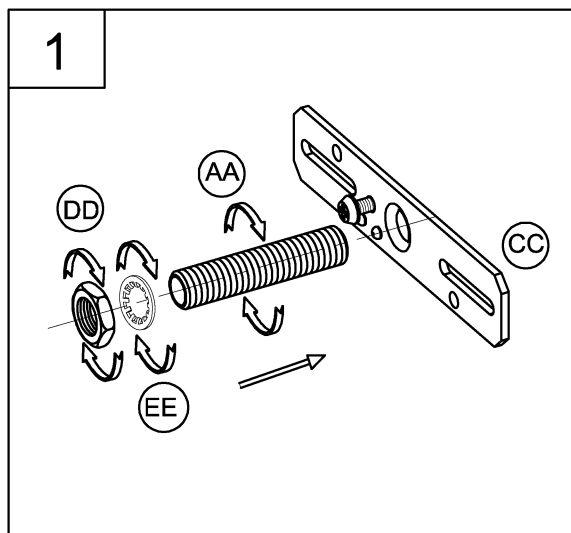

1. Loosely thread the nipple (AA), lock washer (EE) and the hex nut (DD) onto the mounting strap (CC).

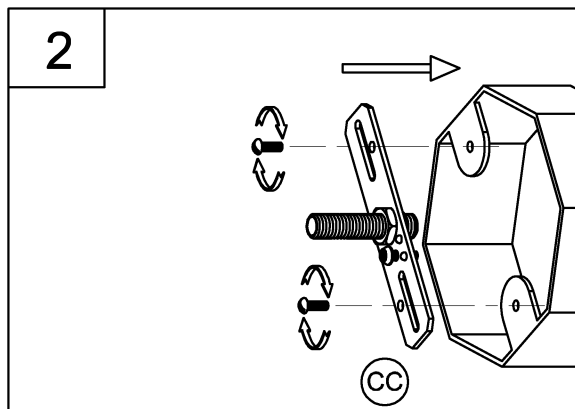

2. Attach this assembly to the outlet box using the mounting screws supplied with the outlet box (not provided). Tighten securely.

Assembly Instructions

3. You now need to adjust the nipple length according to the fixture canopy depth.

Lift up the fixture and pass the nipple (AA) through the center mounting hole in the fixture canopy. While holding the fixture with one hand, thread the nipple (AA) in or out of the mounting strap (CC) until 1/4" of threads are showing. That should be enough to mount the fixture as instructed in step 5.

Next, take the fixture down and go back and tighten the hex nut (DD) up against the mounting strap (CC). You now should have the correct length of threads for mounting the fixture.

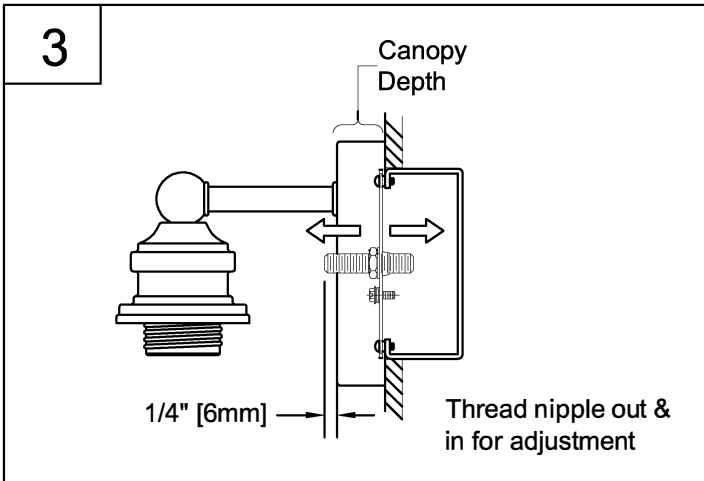

4. Strip 3/8" of insulation from the electrical wire ends. Using wire nuts (BB), connect the WHITE fixture wire to the WHITE supply wire from the outlet box; connect the BLACK fixture wire to the BLACK supply wire from the outlet box.

Connect the fixture ground wire and supply ground wire using a wire nut or by fastening to the ground screw on the round mounting plate. Push all of the wire connections carefully into the outlet box.

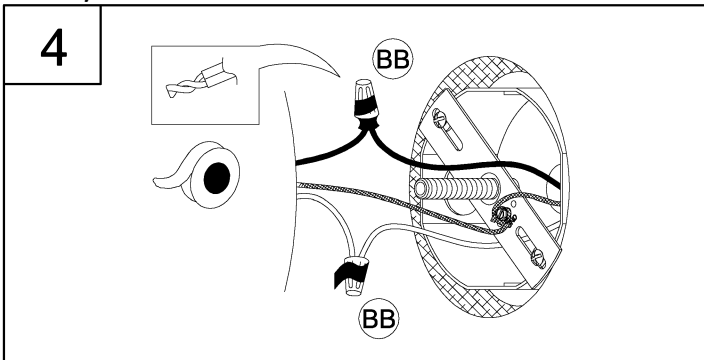

5. Slide the center mounting hole in the fixture (A) over the nipple (AA) and using the finial (FF), tighten the fixture against the mounting surface.

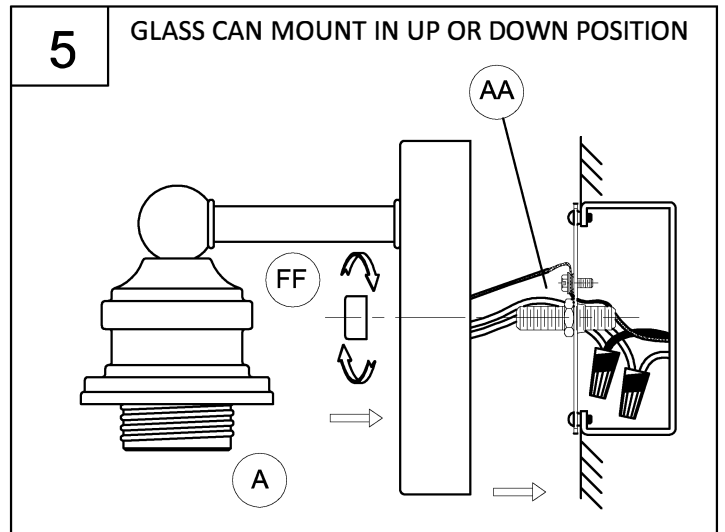

6. Attach the glass shade (B) to fixture (A) using the socket ring (C) to secure tightly.

Thread lamps (not included) into the fixture sockets. Use 60-watt MAX incandescent medium base lamps, SBCFL or SBLED.

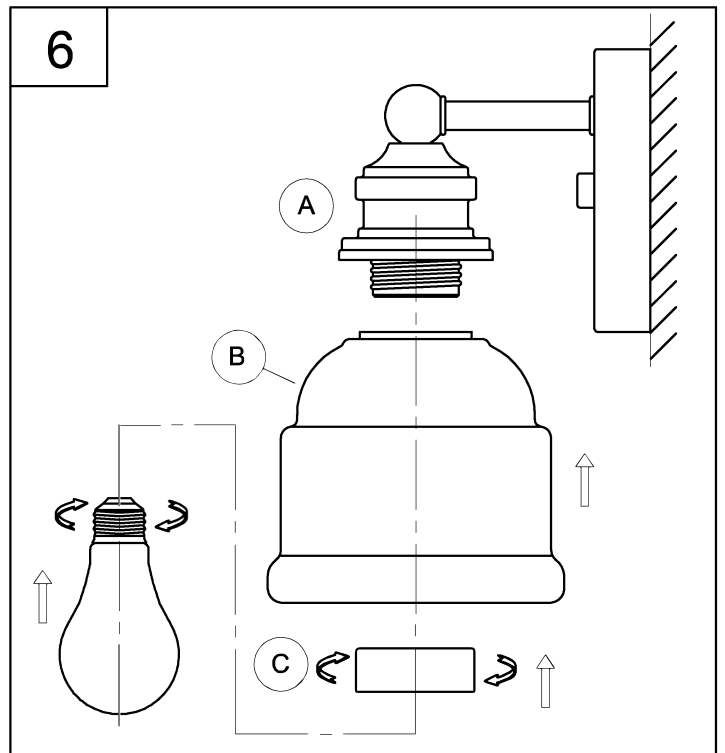

Questions?

Call our Customer Care Team at 1-855-303-4229

urban ambiance

www.urbanambiance.com