

urban ambiance

Installation Instructions: **UHP4281**

PART	DESCRIPTION	QUANTITY		
		3- LIGHT	4- LIGHT	8- LIGHT
A	Fixture	1	1	1
B	Square Tube	4	4	4
C	Top Frame	1	1	1
D	Bottom Frame	1	1	1
E	Body With Square Arm	1	1	1
F	Stem	1	1	1
G	Finial	8	8	8
H	Candle Cover	3	4	8

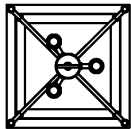
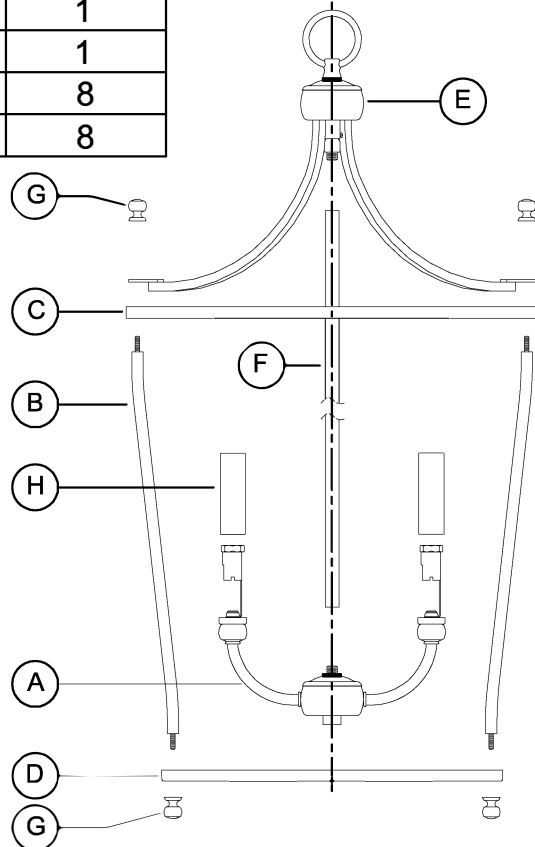
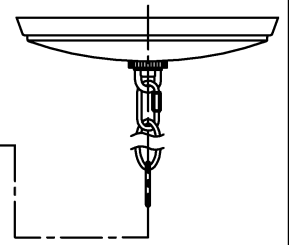

UHP4257
UHP4268
UHP4279

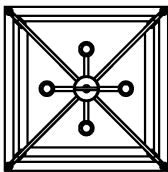

UHP4258
UHP4269
UHP4280

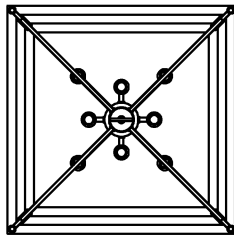

UHP4259
UHP4270
UHP4281

HARDWARE CONTENTS (not actual size)

AA	BB	CC	DD	EE	FF	GG	HH	JJ	KK
Hex Nut	Wire Nut	1/8IP Mounting Plate	Screw Collar	Chain Holder	Nipple	Chain Loop (1/8IP)	Chain	Canopy	Quick link
Qty:2	Qty:3	Qty:1	Qty:1	Qty:1	Qty:1	Qty:1	Qty:1	Qty:1	Qty:1



Questions?

Call our Customer Care Team at 1-855-303-4229

urban ambiance

www.urbanambiance.com



Safety Information

Please read and understand this entire manual before attempting to assemble, operate or install the product.

CAUTION: Read instructions carefully and turn electricity off at main circuit breaker panel before beginning installation.

CAUTION: Risk of fire. Min. 90°C supply conductors. Consult a qualified electrician to ensure correct branch circuit conductor.

WARNING: If any Special Control Devices are used with this fixture, follow instructions carefully to assure full compliance with N.E.C. requirements. If there are any questions, contact a qualified electrical contractor.

CAUTION: All glass is fragile. Use care when handling glass shades and bulbs.

Preparation

1. Before beginning installation, make sure all parts are included using the contents diagrams from page 1. If any part is missing or damaged, do not attempt to assemble, install or operate the product.
2. Estimated assembly time: 30 minutes.
3. Tools required for assembly (not included): Phillips screwdriver, pliers, wire stripper, safety glasses, electrical tape, ladder.

Care and Maintenance

Shut off main power supply before cleaning product or changing light bulbs. To clean, wipe with damp cloth. Do not use abrasive cleaners or cleaners that contain alcohol.

Assembly Instructions

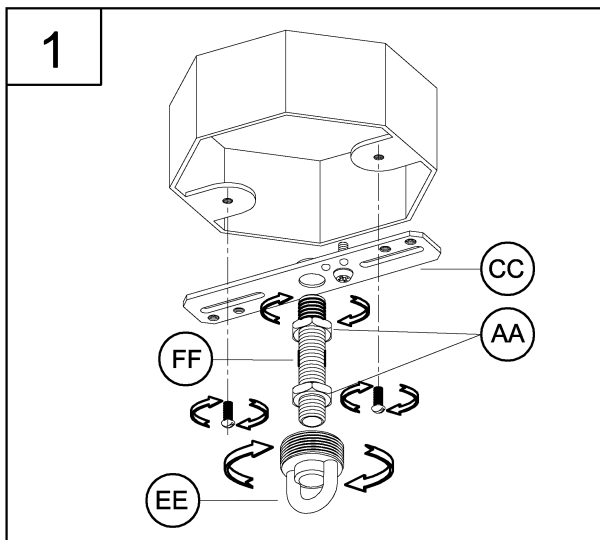

1. Install the chain holder (EE) onto the nipple (FF). Next, loosely thread the hex nuts (AA) onto the nipple (FF) and then thread this assembly onto the mounting plate (CC). Install this assembly to the outlet box using the mounting screws supplied with the outlet box (not included).

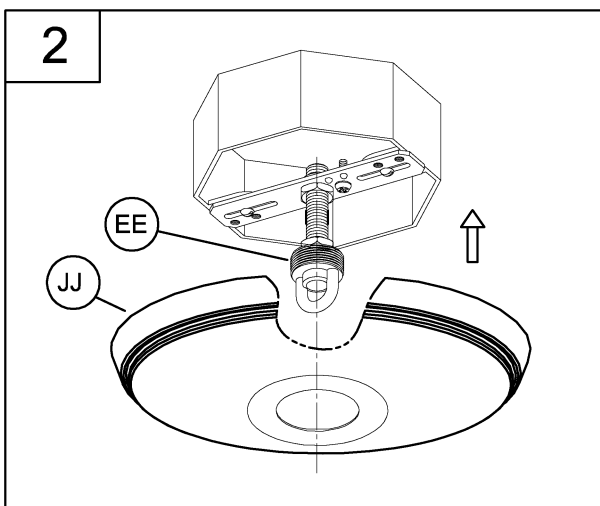

2. In this step, you will adjust the depth of the chain holder in relation to the canopy depth.

Take the canopy (JJ) and slip it over the chain holder (EE). You will need to adjust the chain holder so at least 1/4" of the threaded portion is exposed through the canopy hole. This is done by adjusting the depth of the nipple (FF) on the mounting plate (CC). When the chain holder (EE) is correctly adjusted, remove the canopy (JJ) and tighten the top hex nut (AA) against the mounting plate (CC) and the bottom hex nut (AA) against the chain holder (EE).

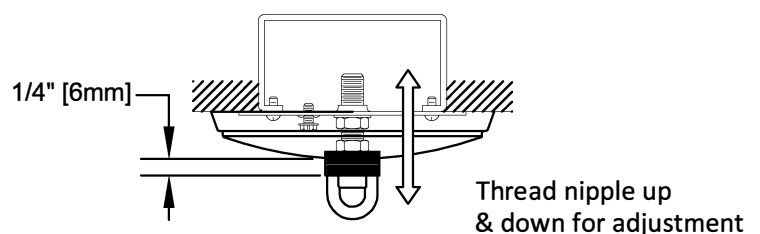

Assembly Instructions

3

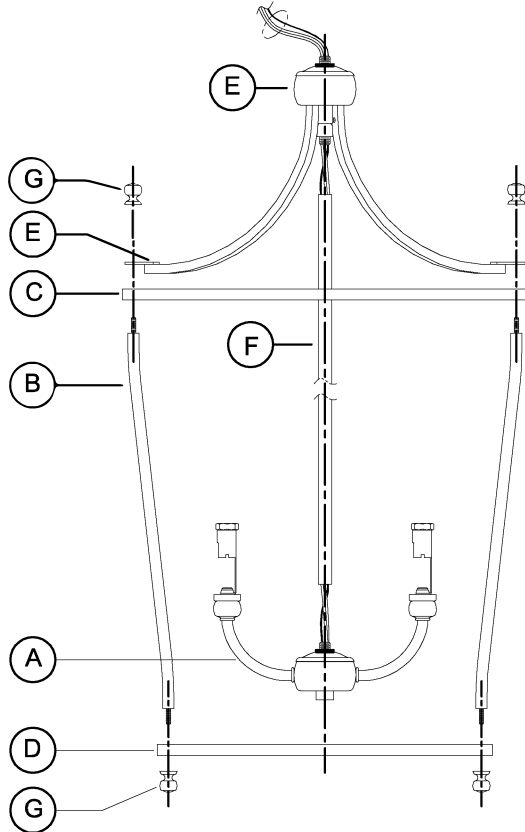

3. Pass the wires from fixture (A) through the stem (F) and body (E). Thread the stem (F) onto the fixture (A). Thread the body (E) onto the stem (F). Secure all parts tightly together.

Attach the top frame (C) and the square tubes (B) to the square arm (E) as shown on the diagram using four finials (G) to secure the parts tightly together. Then, attach the bottom frame (D) to the square tubes (B) using the last four finials (G) to secure the parts tightly together.

4

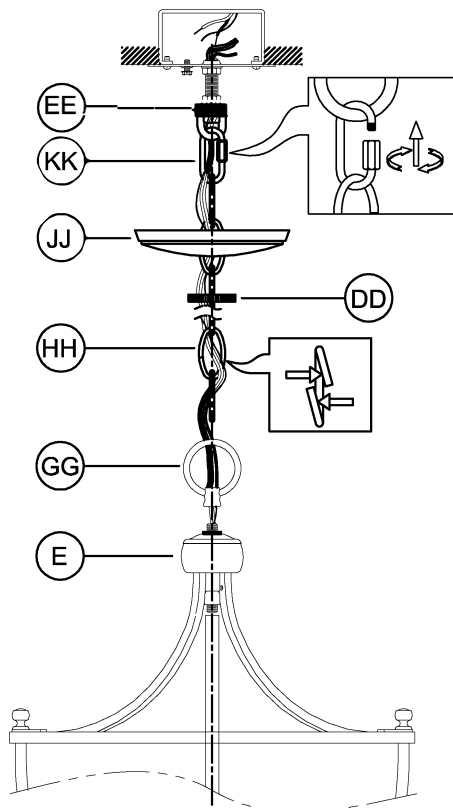

NOTE: During this step, determine the hanging length of your fixture by removing chain links (HH) and optionally cutting the electrical and ground wire to length.

Do NOT cut electrical or ground wires until this overall length is determined. Leave AT LEAST 6 inches MINIMUM of wire past the chain holder (EE) to allow for easy connections in step 5.

(Chain links can be spread open with 2 pairs of pliers. Twist the split link ends in opposite directions and close by squeezing them back together.)

4. Pass the wires from the body (E) through the chain loop. Thread the chain loop (GG) onto the body (E).

Once hanging length is determined, open chain link at one end of chain (HH). Hook the open chain link (HH) onto the chain loop (GG). Close the chain links back together with the pliers. Pass the screw collar (DD) and canopy (JJ) onto the chain (HH). Open the quick link (KK), attach the quick link to the other end of chain (HH) and to the chain holder (EE). Close the quick link (KK).

You can now weave the wires through every third chain link (HH). Continue to pass the wires and chain through the screw collar (DD) and canopy (JJ). Pass the wires through the chain holder (EE) and up into the junction box.

Assembly Instructions

5

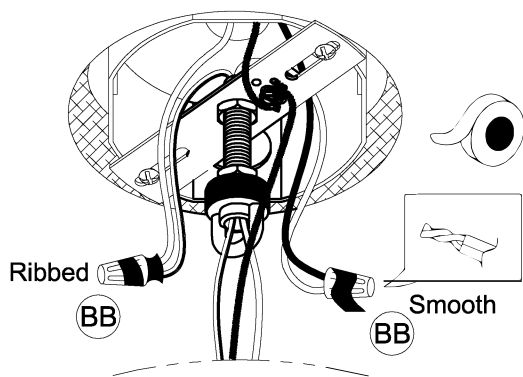

5. Strip 3/8" of insulation from the electrical wire ends. Using wire nuts (BB), connect the RIBBED fixture wire to the WHITE supply wire from the outlet box; connect the SMOOTH fixture wire to the BLACK supply wire.

Connect the fixture ground wire and supply ground wire using a wire nut or by fastening to the ground screw on the mounting strap. Push all wire connections into the outlet box.

6

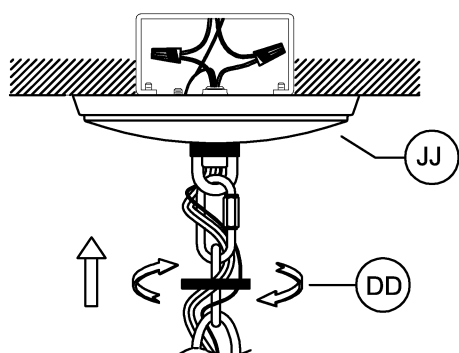

6. Tuck the wires into the junction box and slip the canopy (JJ) over the chain holder. Thread the screw collar (DD) onto the chain holder to secure the canopy tightly to the ceiling.

7

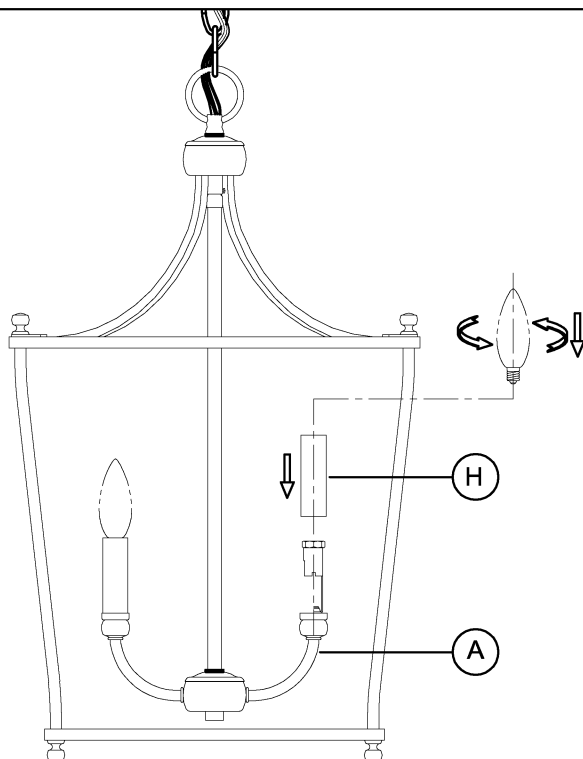

7. Attach candle covers (H) to fixture (A).

Thread the lamps (not included) into the fixture sockets. Use 60-watt MAX incandescent candelabra base, SBCFL or SBLED.



Questions?

Call our Customer Care Team at 1-855-303-4229

urban ambiance

www.urbanambiance.com