

urban ambiance

Installation Instructions: **UHP4234**

PART	DESCRIPTION	QUANTITY	
		UHP4232/4/6	UHP4233/5/7
A	Fixture	1	1
B	Tube assembly	1	2
C	Small cup	1	2
D	Fabric shade - (sold separately) P860059-000		
E	Fabric shade - (sold separately) P860060-000		
F	Glass shade - (sold separately) P860061-068		

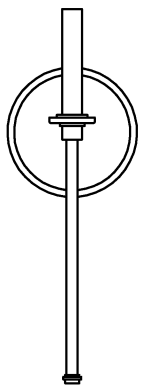
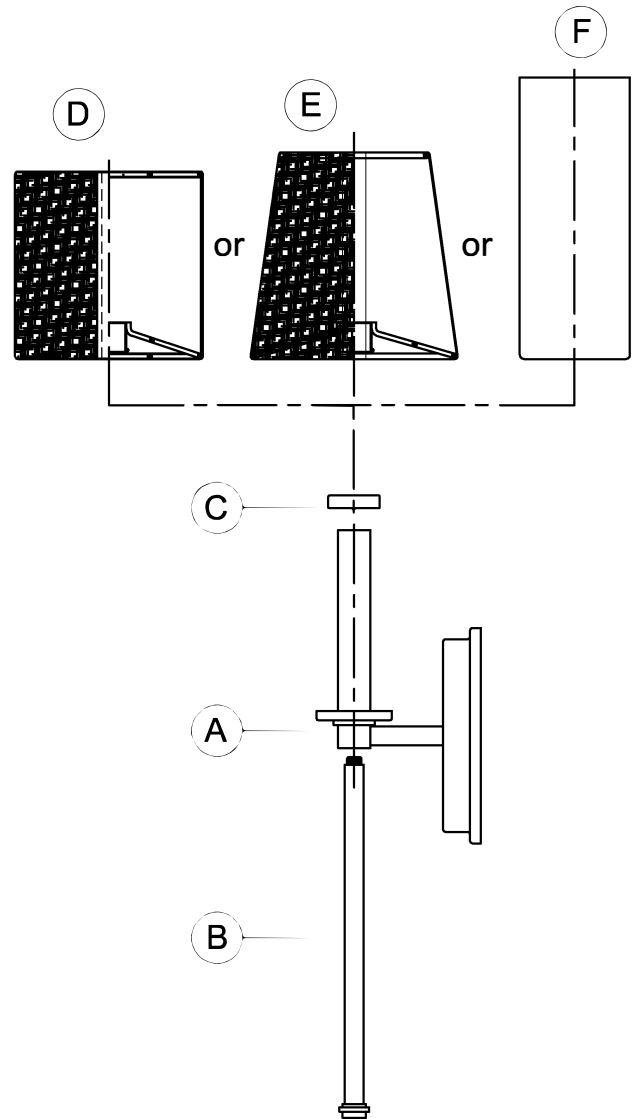

UHP4232/4/6

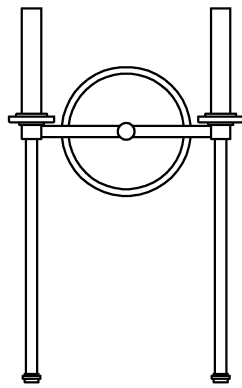

UHP4233/5/7

HARDWARE CONTENTS (not actual size)

AA



Screw
(#8-32)
Qty:1

BB

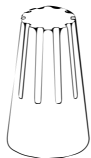

Wire Nut
Qty:3

CC

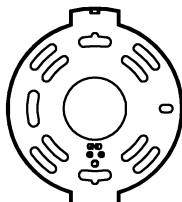

Back Plate
Qty:1



Questions?

Call our Customer Care Team at 1-855-303-4229

urban ambiance

www.urbanambiance.com



Safety Information

Please read and understand this entire manual before attempting to assemble, operate or install the product.

CAUTION: Read instructions carefully and turn electricity off at main circuit breaker panel before beginning installation.

CAUTION: Risk of fire. Min. 90°C supply conductors. Consult a qualified electrician to ensure correct branch circuit conductor.

WARNING: If any Special Control Devices are used with this fixture, follow instructions carefully to assure full compliance with N.E.C. requirements. If there are any questions, contact a qualified electrical contractor.

CAUTION: All glass is fragile. Use care when handling glass shades and bulbs.

Preparation

1. Before beginning installation, make sure all parts are included using the contents diagrams from page 1. If any part is missing or damaged, do not attempt to assemble, install or operate the product.
2. Estimated assembly time: 30 minutes.
3. Tools required for assembly (not included): Phillips screwdriver, pliers, wire stripper, safety glasses, electrical tape, ladder.

Care and Maintenance

Shut off main power supply before cleaning product or changing light bulbs. To clean, wipe with damp cloth. Do not use abrasive cleaners or cleaners that contain alcohol.

Assembly Instructions

1

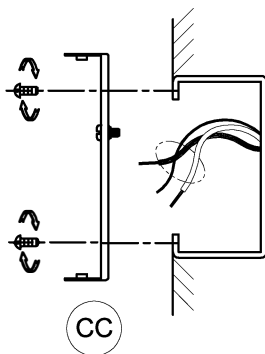

1. Attach the back plate (CC) to the outlet box using the mounting screws supplied with the outlet box (not provided). Tighten securely.

2

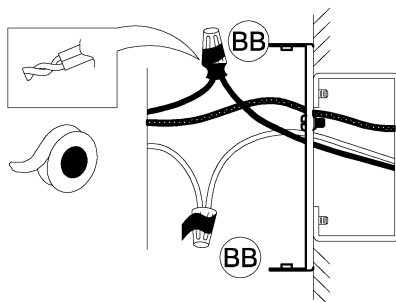

2. Strip 3/8" of insulation from the electrical wire ends. Using wire nuts (BB), connect the WHITE fixture wire to the WHITE supply wire from the outlet box; connect the BLACK fixture wire to the BLACK supply wire from the outlet box.

Connect the fixture ground wire and supply ground wire using a wire nut or by fastening to the ground screw on the round mounting plate. Push all of the wire connections carefully into the outlet box.

Assembly Instructions

3

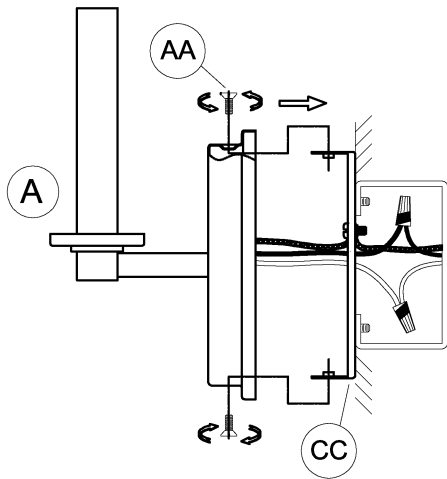

3. Attach the fixture (A) to back plate (CC) of outlet box, using the screw (AA), tighten the fixture against the mounting surface.

4

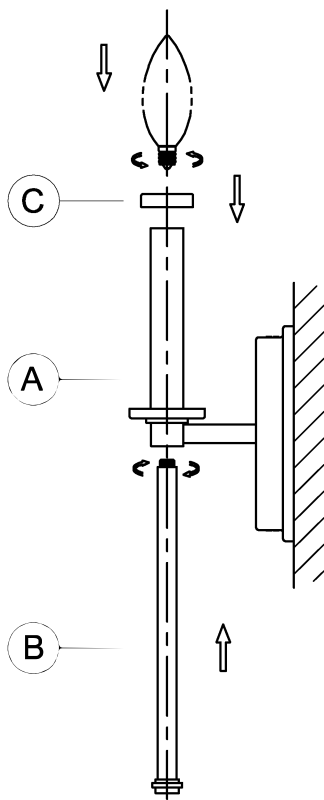

4. Thread the tube assembly (B) to the fixture (A), tighten securely.

Attach the small cup (C) to the glass holder of fixture (A).

OPTIONAL ACCESSORY: Attach the fabric shade (D or (E) - sold separately - to the candle tube.

Thread the lamps (not included) into the fixture sockets. Use 60-watt MAX incandescent candelabra base lamp, SBCFL or SBLED.

OPTIONAL ACCESSORY: Attach the glass shade (F) - sold separately - to the glass holder on the fixture (A).

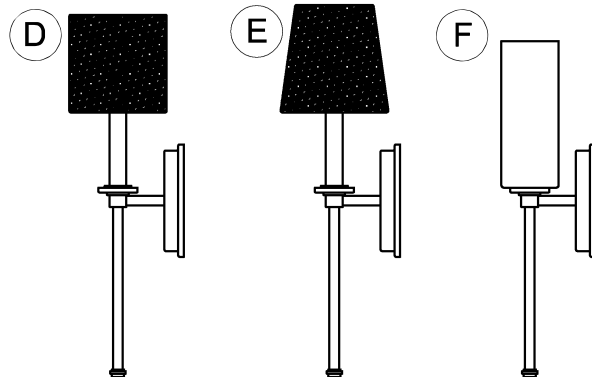

Questions?

Call our Customer Care Team at 1-855-303-4229

urban ambiance

www.urbanambiance.com