

PART	DESCRIPTION	QUANTITY	
		UHP4192	UHP4193
A	Fixture	1	1
B	Glass shade	3	4

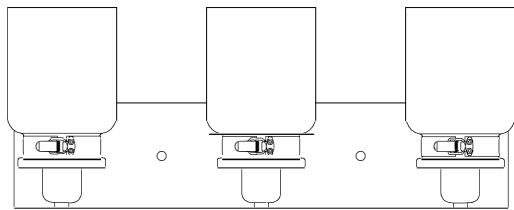

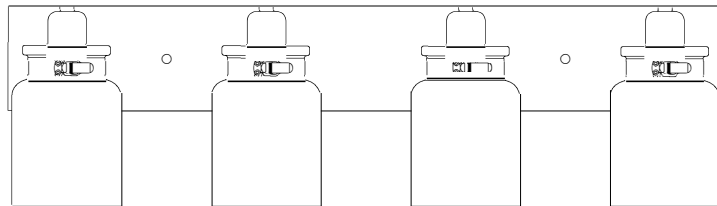

UHP4192

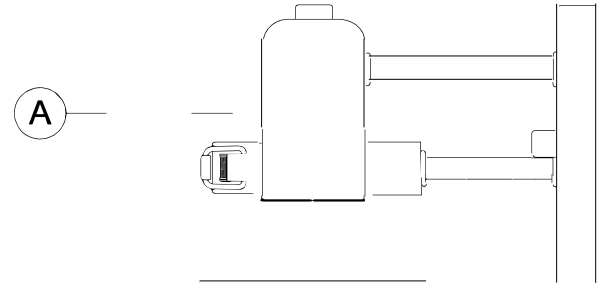

UHP4193

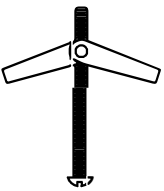
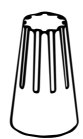
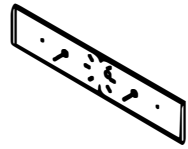
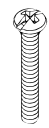
HARDWARE CONTENTS (not actual size)

<p style="text-align: center;">AA</p>  <p>Toggle bolt (#10-24) Qty:2</p>	<p style="text-align: center;">BB</p>  <p>Wire nut Qty:3</p>	<p style="text-align: center;">CC</p>  <p>Back plate (showing screw (DD) and hex nut (EE)) Qty:1</p>	<p style="text-align: center;">DD</p>  <p>Screw (pre-assembled to back plate) (#8-32) Qty:2</p>	<p style="text-align: center;">EE</p>  <p>Hex nut (pre-assembled to back plate) (#8-32) Qty:2</p>	<p style="text-align: center;">FF</p>  <p>Cylinder nut (#8-32) Qty:2</p>	
--	---	---	--	--	---	--



Questions?

Call our Customer Care Team at 1-855-303-4229



Safety Information

Please read and understand this entire manual before attempting to assemble, operate or install the product.

CAUTION: Read instructions carefully and turn electricity off at main circuit breaker panel before beginning installation.

CAUTION: Risk of fire. Min. 90°C supply conductors. Consult a qualified electrician to ensure correct branch circuit conductor.

WARNING: If any Special Control Devices are used with this fixture, follow instructions carefully to assure full compliance with N.E.C. requirements. If there are any questions, contact a qualified electrical contractor.

CAUTION: All glass is fragile. Use care when handling glass shades and bulbs.

Preparation

1. Before beginning installation, make sure all parts are included using the contents diagrams from page 1. If any part is missing or damaged, do not attempt to assemble, install or operate the product.
2. Estimated assembly time: 30 minutes.
3. Tools required for assembly (not included): Phillips screwdriver, pliers, wire stripper, safety glasses, electrical tape, ladder and drill.

Care and Maintenance

Shut off main power supply before cleaning product or changing light bulbs. To clean, wipe with damp cloth. Do not use abrasive cleaners or cleaners that contain alcohol.

Assembly Instructions

1

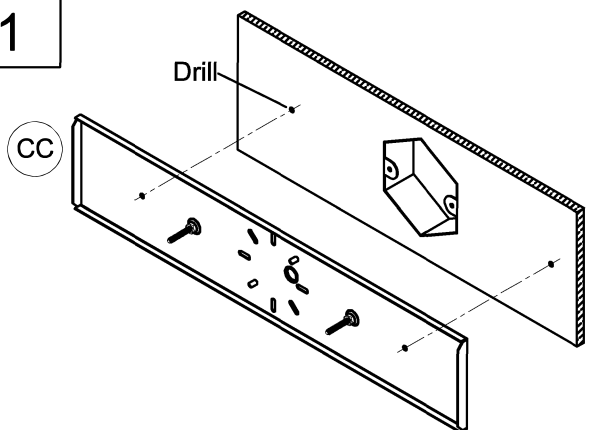

1. Place back plate (CC) on wall and use a pencil to mark the locations of the 2 mounting holes. Remove the fixture from the wall. Drill (2) $\text{\O}1/2''$ ($\text{\O}12.5\text{mm}$) holes for mounting with toggle.

Ensure that screws (DD) and hex nuts (EE) are securely tightened to back plate (CC).

Hardware Used



Back plate

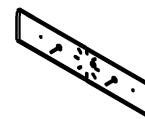

X1

2

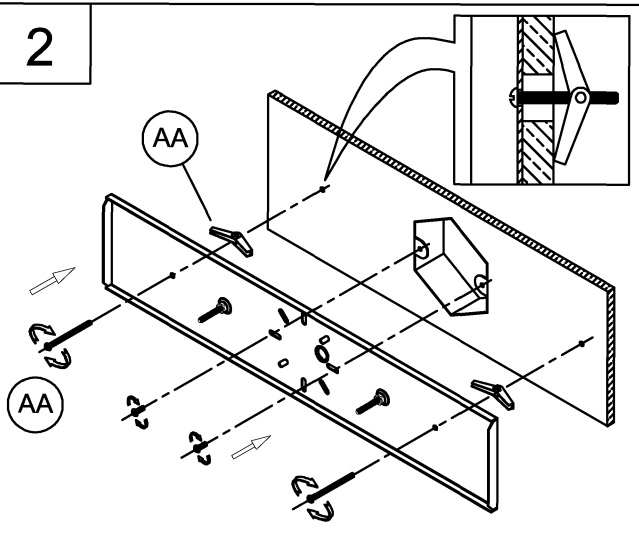

2. Attach back plate (CC) to the wall, using the toggle bolt (AA) and the mounting screws supplied with the outlet box to secure tightly (not included).



Toggle bolt

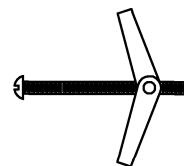

X2

Assembly Instructions

3

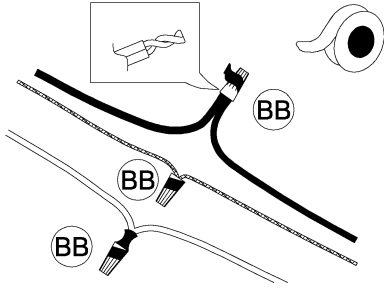

3. Strip 3/8" of insulation from the electrical wire ends. Using wire nuts (BB), connect white fixture wire to the white supply wire from the outlet box; connect the black fixture wire to the black supply wire.

Connect the fixture ground wire and supply ground wire using a wire nut or by fastening to the ground screw on the mounting plate. Push all wire connections into the outlet box.

BB Wire nut

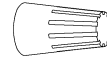

X3

4. Attach fixture (A) to screws (DD) use cylinder nuts (FF) to Secure tightly.

NOTE: Can be mounted UP or DOWN.

FF Cylinder nut



X2

4

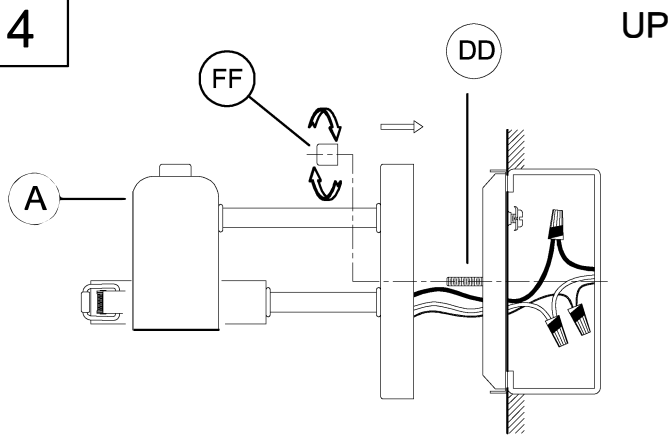

UP

DOWN

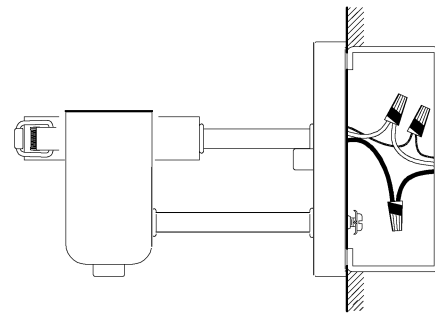

5

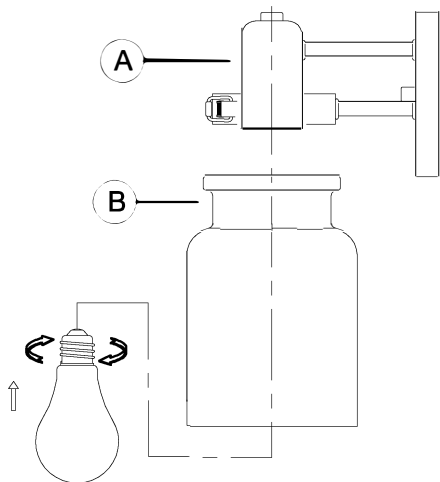

5. Attach glass shade (B) to fixture (A) use spring latch to hold on the glass.

Screw lamp (not included) into fixture socket. Use 100-watt MAX incandescent medium base lamp, SBCFL or SBLED.

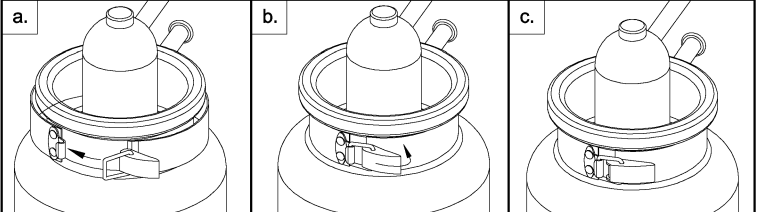

Questions?

Call our Customer Care Team at 1-855-303-4229

urban ambiance

www.urbanambiance.com