

urban ambiance

Installation Instructions: **UHP4184**

PART	DESCRIPTION	QUANTITY			
		UHP4180/4	UHP4181/5	UHP4182/6	UHP4183/7
A	Fixture	1	1	1	1
B	Glass Shade	1	2	3	4
C	Socket Ring	1	2	3	4

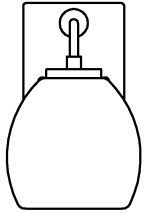

UHP4180/UHP4184

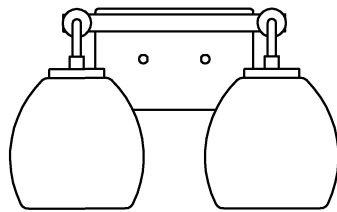

UHP4181/UHP4185

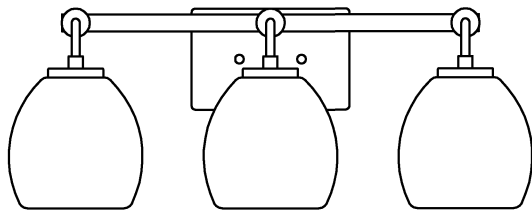

UHP4182/UHP4186

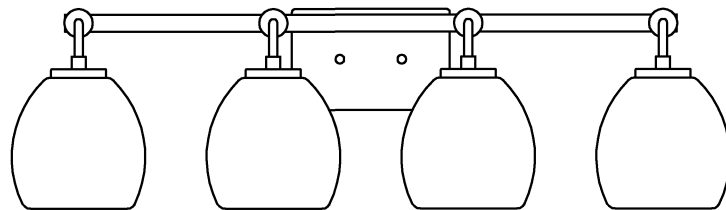

UHP4183/UHP4187

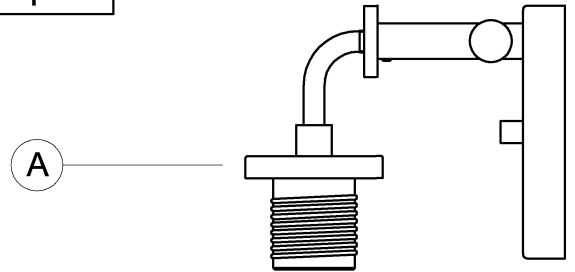

A

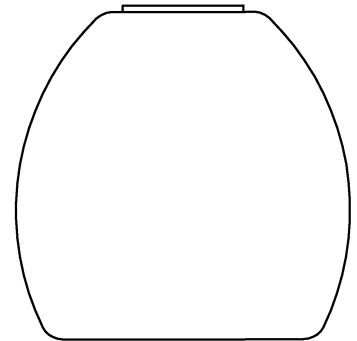

B



C

HARDWARE CONTENTS (not actual size)

AA

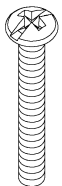

Screw
(#8-32)
Qty:2

BB

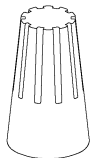

Wire nut
Qty:3

CC

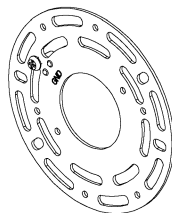

Round Mounting Plate
Qty:1

DD



Hex nut
(#8-32)
Qty:2

EE



Cylinder nut
(#8-32)
Qty:2



Questions?

Call our Customer Care Team at 1-855-303-4229

urban ambiance

www.urbanambiance.com



Safety Information

Please read and understand this entire manual before attempting to assemble, operate or install the product.

CAUTION: Read instructions carefully and turn electricity off at main circuit breaker panel before beginning installation.

CAUTION: Risk of fire. Min. 90°C supply conductors. Consult a qualified electrician to ensure correct branch circuit conductor.

WARNING: If any Special Control Devices are used with this fixture, follow instructions carefully to assure full compliance with N.E.C. requirements. If there are any questions, contact a qualified electrical contractor.

CAUTION: All glass is fragile. Use care when handling glass shades and bulbs.

Preparation

1. Before beginning installation, make sure all parts are included using the contents diagrams from page 1. If any part is missing or damaged, do not attempt to assemble, install or operate the product.
2. Estimated assembly time: 30 minutes.
3. Tools required for assembly (not included): Phillips screwdriver, pliers, wire stripper, safety glasses, electrical tape, ladder.

Care and Maintenance

Shut off main power supply before cleaning product or changing light bulbs. To clean, wipe with damp cloth. Do not use abrasive cleaners or cleaners that contain alcohol.

Assembly Instructions

1

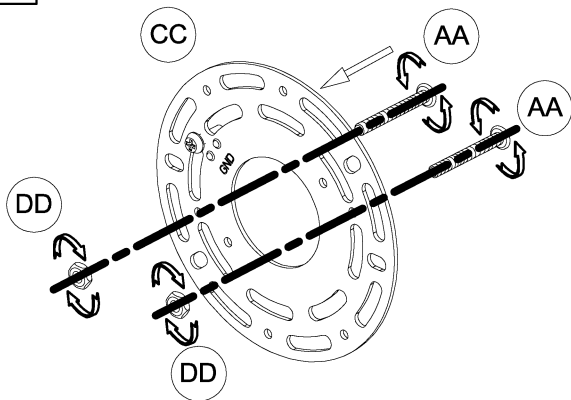

1. Screw screw (AA) onto round mounting plate (CC) and use hex nut (DD) to secure it tight.

Hardware Used

AA	Screw		X2
CC	Round Mounting Plate		X1
DD	Hex nut		X2

2

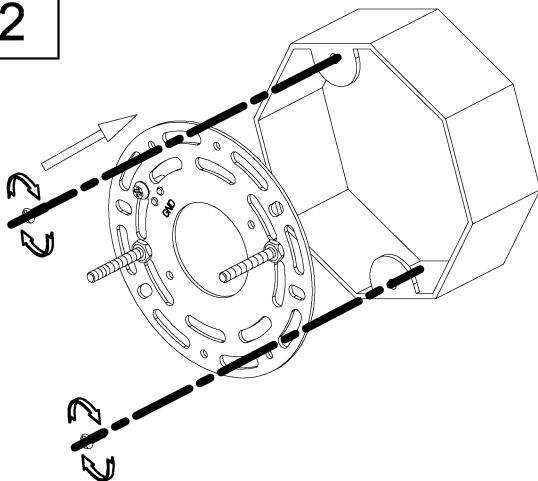

2. Attach assembled parts from Step 1 onto outlet box using the mounting screws supplied with the outlet box (not included).

Assembly Instructions

3

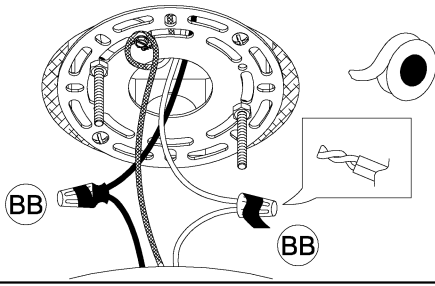

3. Strip 3/8" of insulation from the electrical wire ends. Using wire nuts (BB), connect white fixture wire to the white supply wire from the outlet box; connect the black fixture wire to the black supply wire. Connect the fixture ground wire and supply ground wire using a wire nut or by fastening to the ground screw on the round mounting plate. Push all wire connections into the outlet box.

BB

Wire nut



X3

4

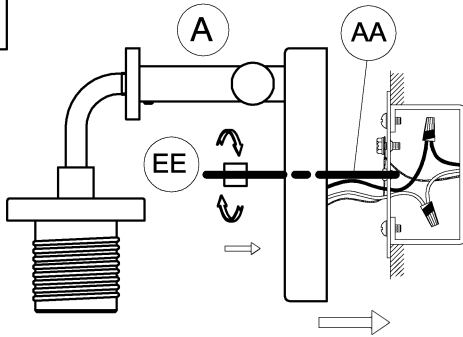

4. Attach fixture (A) to screws (AA) using cylinder nut (EE) secure tightly.

EE

Cylinder nut



X2

a

UP or DOWN
MOUNTING

b

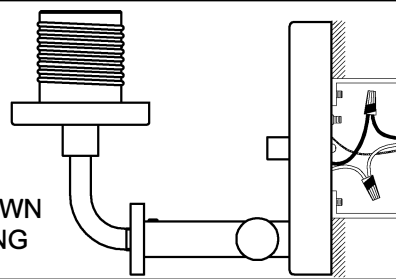

5

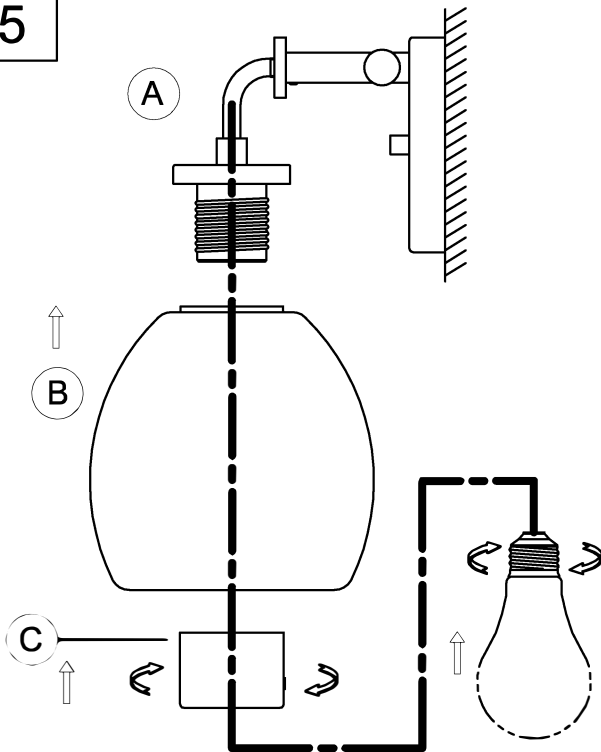

5. Attach glass (B) to fixture (A) and use socket ring (C) to secure tightly.

Screw lamp (not included) into fixture socket. Use 60-watt MAX incandescent medium base lamp, SBCFL or SBLED.



Questions?

Call our Customer Care Team at 1-855-303-4229

urban ambiance

www.urbanambiance.com