

urban ambiance

Installation Instructions: **UHP4173**

PART	DESCRIPTION	QUANTITY			
		UHP4170	UHP4171	UHP4172	UHP4173
A	Fixture	1	1	1	1
B	Glass shade	1	2	3	4
C	Socket ring	1	2	3	4

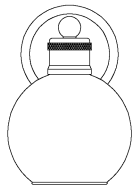

UHP4170

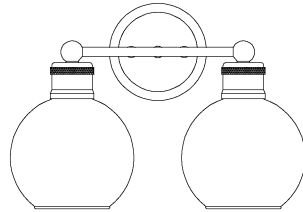

UHP4171

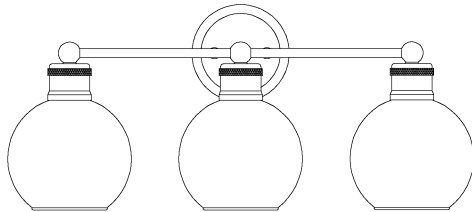



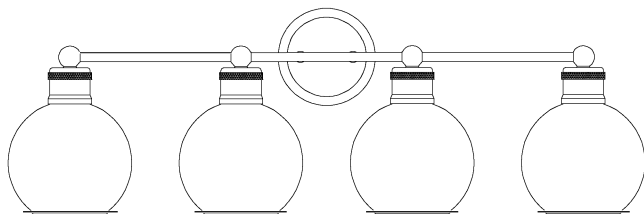

UHP4172

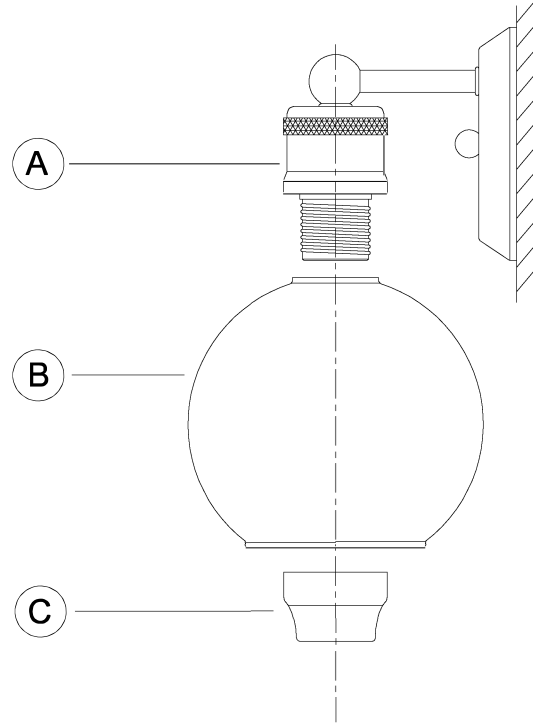

UHP4173

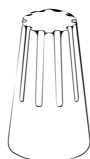

HARDWARE CONTENTS (not actual size)

AA	BB	CC	DD	EE	
					
Hex nut	Wire nut	Mounting strap (1/8IP)	Ball nut (1/8IP)	Nipple	
Qty:2	Qty:3	Qty:1	Qty:1	Qty:1	



Questions?

Call our Customer Care Team at 1-855-303-4229

urban ambiance

www.urbanambiance.com



Safety Information

Please read and understand this entire manual before attempting to assemble, operate or install the product.

CAUTION: Read instructions carefully and turn electricity off at main circuit breaker panel before beginning installation.

CAUTION: Risk of fire. Min. 90°C supply conductors. Consult a qualified electrician to ensure correct branch circuit conductor.

WARNING: If any Special Control Devices are used with this fixture, follow instructions carefully to assure full compliance with N.E.C. requirements. If there are any questions, contact a qualified electrical contractor.

CAUTION: All glass is fragile. Use care when handling glass shades and bulbs.

Preparation

1. Before beginning installation, make sure all parts are included using the contents diagrams from page 1. If any part is missing or damaged, do not attempt to assemble, install or operate the product.
2. Estimated assembly time: 30 minutes.
3. Tools required for assembly (not included): Phillips screwdriver, pliers, wire stripper, safety glasses, electrical tape, ladder.

Care and Maintenance

Shut off main power supply before cleaning product or changing light bulbs. To clean, wipe with damp cloth. Do not use abrasive cleaners or cleaners that contain alcohol.

Assembly Instructions

1

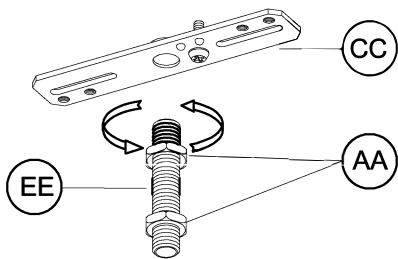

1. Screw threaded nipple (FF) into mounting strap (CC) several turns. Use one hex nut (AA) to secure parts tightly. Screw one hex nut (AA) onto threaded nipple (FF). Tighten the hex nut against the top of the chain holder.

Hardware Used

	Hex nut		X2
	Mounting strap		X1
	Nipple		X1

2

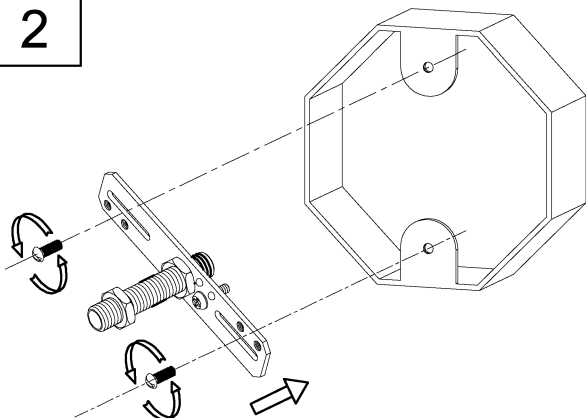

2. Attach assembled parts from step 1 onto junction box, using the mounting screws supplied with the junction box (not included).

Assembly Instructions

3. Strip 3/8" of insulation from the electrical wire ends. Using wire nuts (BB), connect white fixture wire to the white supply wire from the junction box; connect the black fixture wire to the black supply wire.

Connect the fixture ground wire and supply ground wire using a wire nut or by fastening to the ground screw on the round mounting plate. Push all wire connections into the outlet box.

BB Wire nut X3

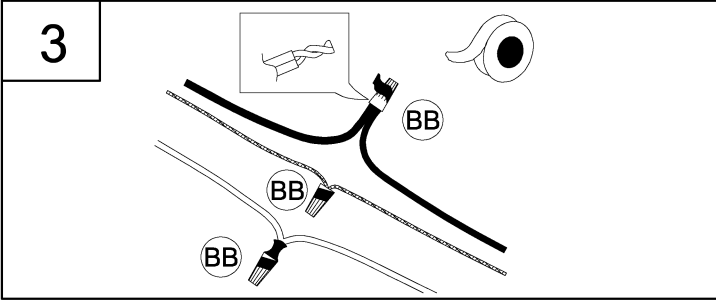

4. Attach fixture (A) to screws (AA) using cylinder nuts (EE). Secure tightly.

EE Ball nut X2 Can be mounted UP or DOWN

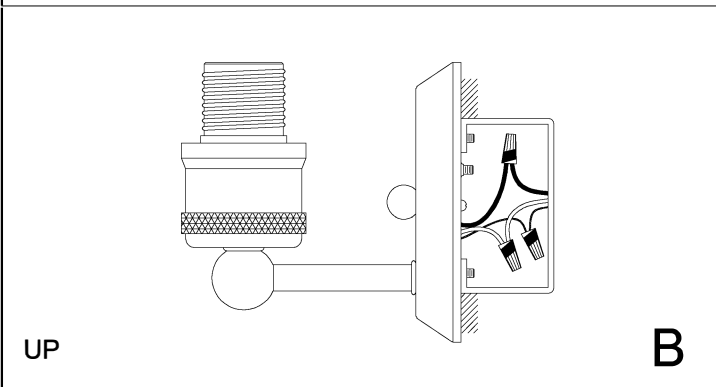
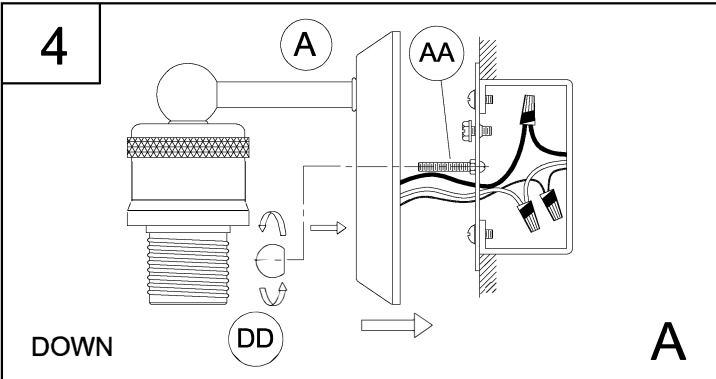

5. Attach glass (B) to fixture (A) using socket ring (C) to secure tight.

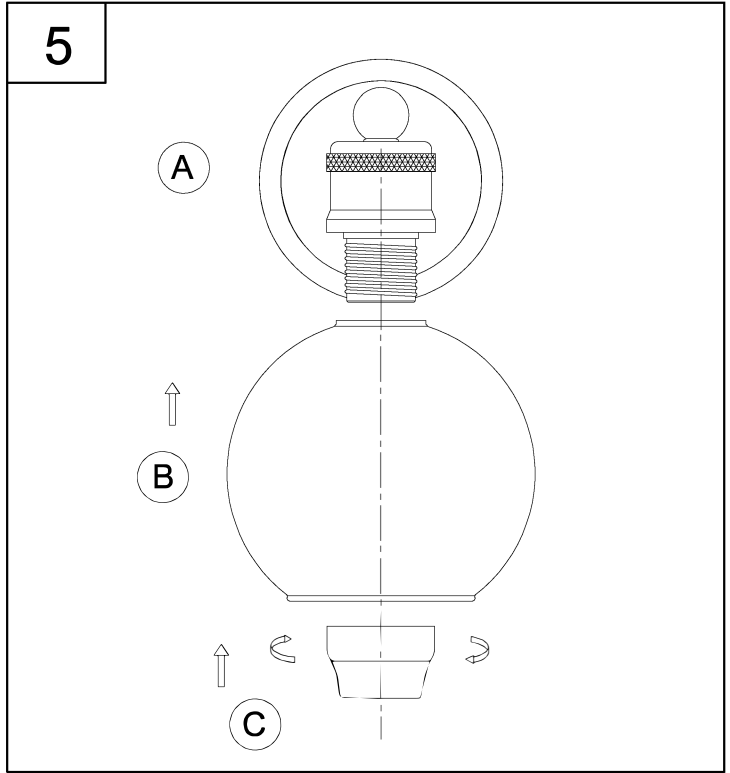

6. Screw lamp (not included) into fixture socket. Use 100-watt MAX incandescent medium base lamp, SBCFL or SBLED.

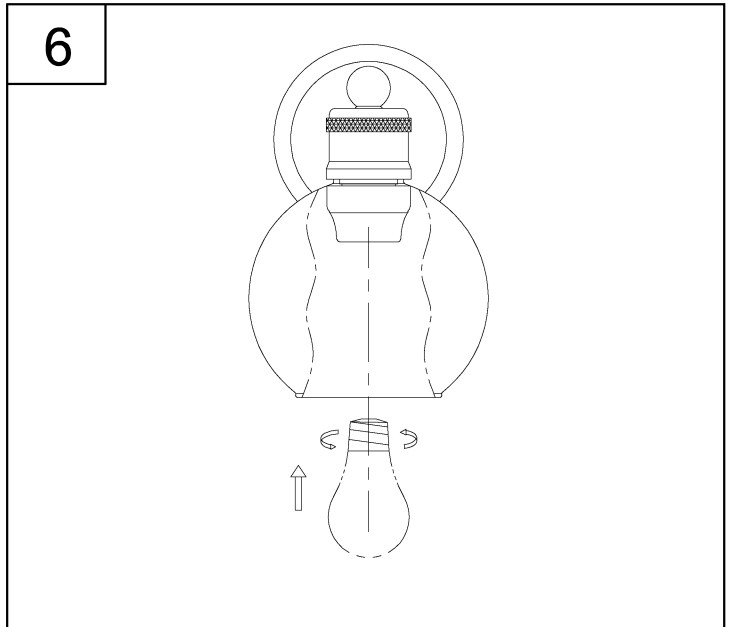

Questions?

Call our Customer Care Team at 1-855-303-4229

urban ambiance

www.urbanambiance.com