

# urban ambiance

Installation Instructions: **UHP4121**

PART	DESCRIPTION	QUANTITY	
		UHP4120/2	UHP4121/3
A	Fixture	1	1

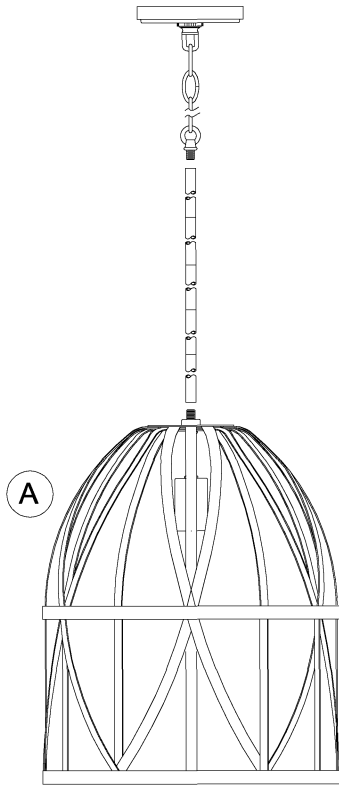

UHP4120/2

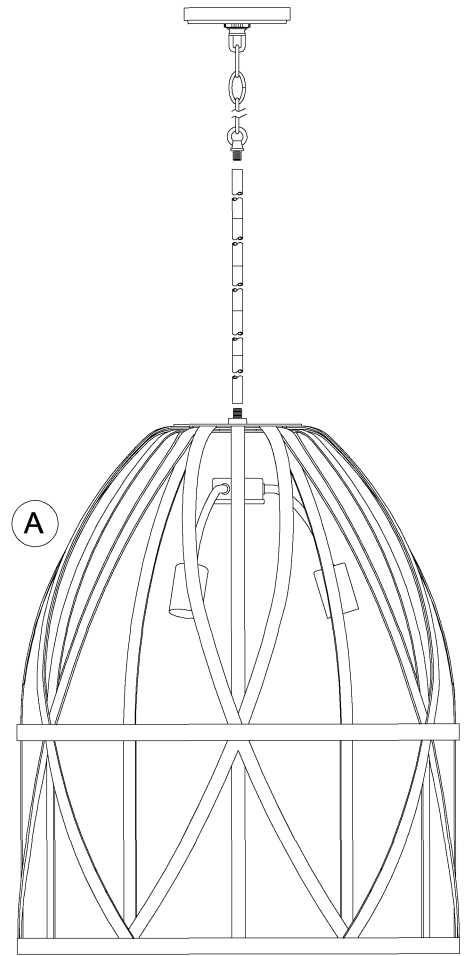

UHP4121/3

## HARDWARE CONTENTS (not actual size)

AA	BB	CC	DD	EE	FF	GG	HH	JJ	KK	LL	MM
Nipple (1/8IP) Qty:1	Wire nut Qty:3	1/8IP Mounting strap Qty:1	Hex nut (1/8IP) Qty:2	Chain holder (1/8IP) Qty:1	Screw collar Qty:1	Chain (6 links) Qty:1	Canopy Qty:1	12" Pipe (1/8IP) Qty:4	6" Pipe (1/8IP) Qty:1	Nipple (1/8IP) Qty:4	Chain loop (1/8IP) Qty:1



### Questions?

Call our Customer Care Team at 1-855-303-4229

urban ambiance

[www.urbanambiance.com](http://www.urbanambiance.com)



## Safety Information

Please read and understand this entire manual before attempting to assemble, operate or install the product.

**CAUTION:** Read instructions carefully and turn electricity off at main circuit breaker panel before beginning installation.

**CAUTION:** Risk of fire. Min. 90°C supply conductors. Consult a qualified electrician to ensure correct branch circuit conductor.

**WARNING:** If any Special Control Devices are used with this fixture, follow instructions carefully to assure full compliance with N.E.C. requirements. If there are any questions, contact a qualified electrical contractor.

**CAUTION:** All glass is fragile. Use care when handling glass shades and bulbs.

## Preparation

1. Before beginning installation, make sure all parts are included using the contents diagrams from page 1. If any part is missing or damaged, do not attempt to assemble, install or operate the product.
2. Estimated assembly time: 30 minutes.
3. Tools required for assembly (not included): Phillips screwdriver, pliers, wire stripper, safety glasses, electrical tape, ladder.

## Care and Maintenance

Shut off main power supply before cleaning product or changing light bulbs. To clean, wipe with damp cloth. Do not use abrasive cleaners or cleaners that contain alcohol.



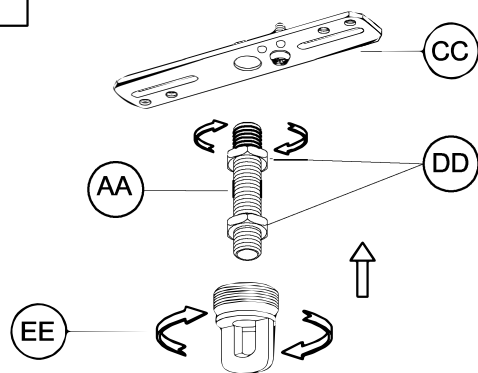

## Assembly Instructions

1



1. Screw threaded nipple (AA) into mounting strap (CC) several turns. Use one hex nut (DD) to secure parts tightly. Screw one hex nut (DD) and chain holder (EE) onto threaded nipple (AA). Tighten the hex nut against the top of the chain holder.

### Hardware Used

(DD)	Hex nut		X2
(AA)	Nipple		X1
(CC)	Mounting strap		X1
(EE)	Chain holder		X1

2

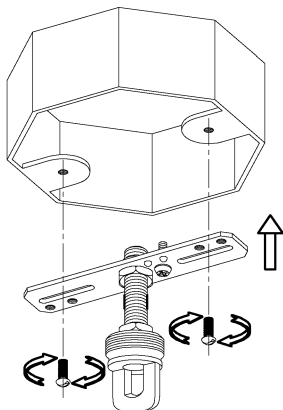















2. Attach assembled parts from Step 1 onto outlet box using the mounting screws supplied with the outlet box (not included).

# Assembly Instructions

3. Pass the wires through the one pipe (KK)/nipple (LL)/ four pipe (JJ) to achieve overall desired length. Next attach pipe (KK) onto fixture. Secure tightly. Weave electric cord and ground wire through chain (FF) and chain loop (MM). Open two links of chain and attach both ends to the chain loop (MM) and chain holder (EE). Close the chain links.

NOTE: During this step, you may choose to shorten the chain and electrical/ground wires.

-  Chain  X1
-  Screw collar  X1
-  Canopy  X1
-  12" Pipe  X4
-  6" Pipe  X1
-  Nipple  X4
-  Chain loop  X1

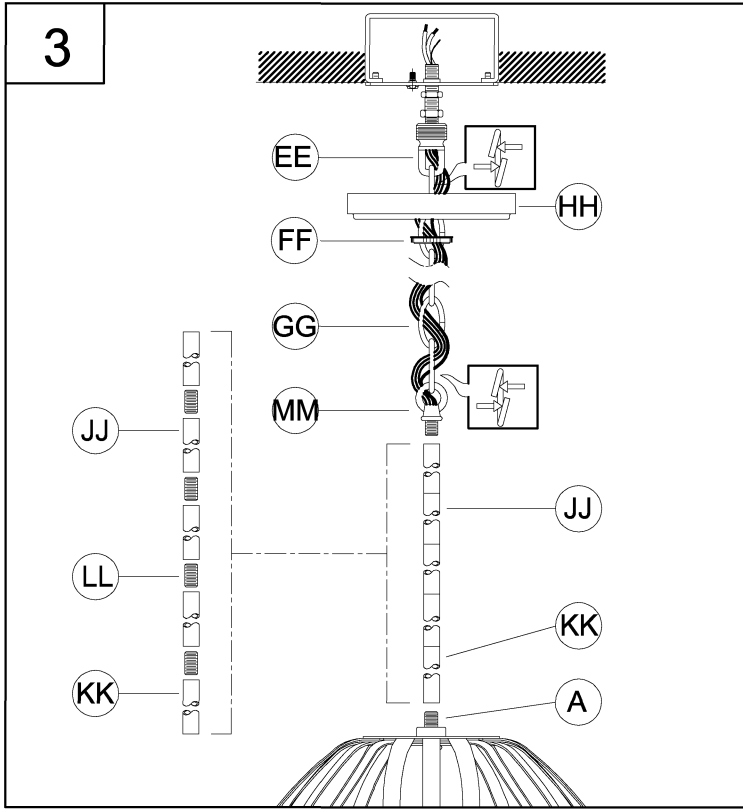

4. Strip 3/8" of insulation from the electrical wire ends. Using wire nuts (BB), connect RIBBED fixture wire to the WHITE supply wire from the outlet box; connect the SMOOTH fixture wire to the BLACK supply wire. Connect the fixture ground wire and supply ground wire using a wire nut or by fastening to the ground screw on the round mounting plate. Push all wire connections into the outlet box.

-  Wire nut  X3

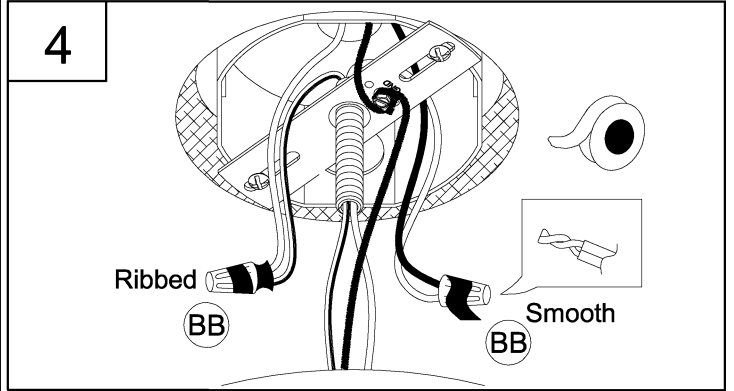

5. Tuck the wires into the outlet box and slip the canopy (HH) over the chain holder. Thread the screw collar (FF) onto the chain holder to secure the canopy tightly to the ceiling.

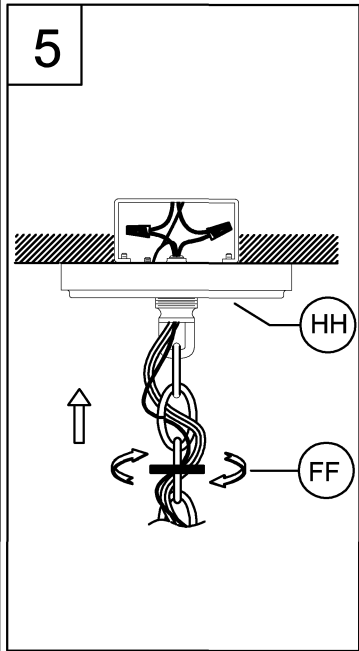

6. Screw lamp (not included) into fixture socket. Use 60-watt MAX incandescent medium base lamp, SBCFL or SBLED.

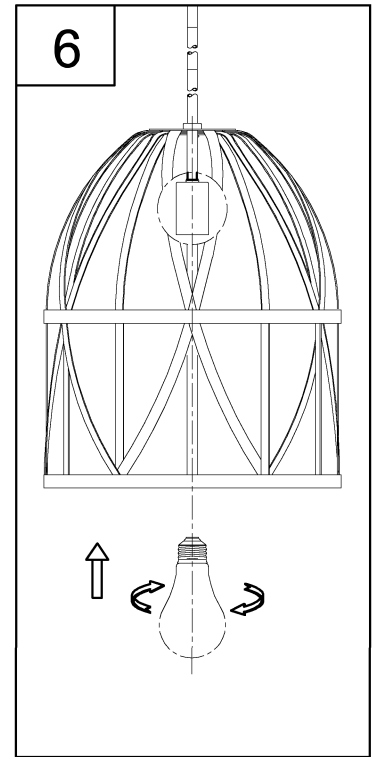

## Questions?

Call our Customer Care Team at 1-855-303-4229

urban ambiance

[www.urbanambiance.com](http://www.urbanambiance.com)