

urban ambiance

Installation Instructions: **UHP4017**

PART	DESCRIPTION	QUANTITY		
		UHP4010,11,12	UHP4013,14,15	UHP4016,17,18
A	Fixture	1	1	1
B	Glass globe	1	1	1
C	Glass cover	1	1	1
D	Knurled nut	1	1	1
E	Slip finial	1	1	1

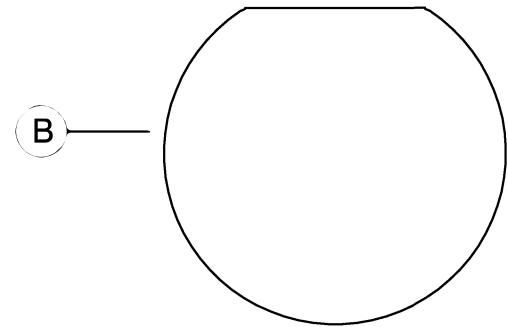
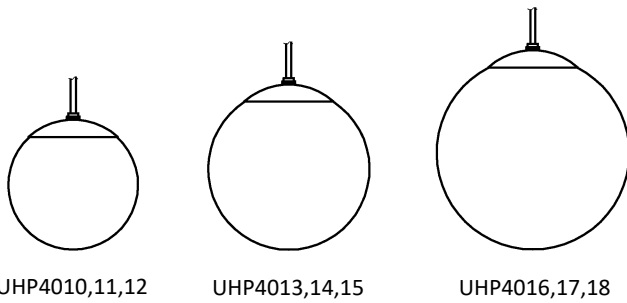
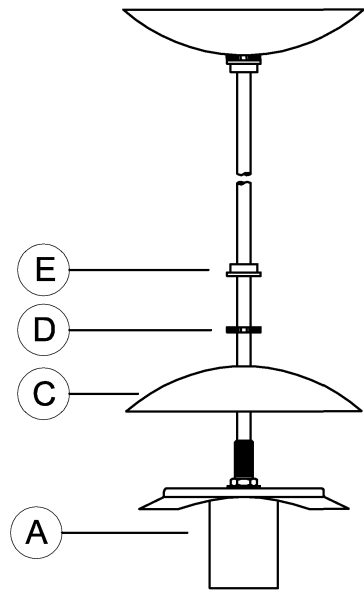

HARDWARE CONTENTS (not actual size)

AA	BB	CC	DD	EE	FF	GG	HH
Hex nut	Wire nut	Mounting strap	Knurled nut	Slip finial	Nipple	Canopy	Strain relief
Qty:2	Qty:3	Qty:1	Qty:1	Qty:1	Qty:1	Qty:1	Qty:1



Questions?

Call our Customer Care Team at 1-855-303-4229

urban ambiance

www.urbanambiance.com



Safety Information

Please read and understand this entire manual before attempting to assemble, operate or install the product.

CAUTION: Read instructions carefully and turn electricity off at main circuit breaker panel before beginning installation.

CAUTION: Risk of fire. Min. 90°C supply conductors. Consult a qualified electrician to ensure correct branch circuit conductor.

WARNING: If any Special Control Devices are used with this fixture, follow instructions carefully to assure full compliance with N.E.C. requirements. If there are any questions, contact a qualified electrical contractor.

CAUTION: All glass is fragile. Use care when handling glass shades and bulbs.

Preparation

1. Before beginning installation, make sure all parts are included using the contents diagrams from page 1. If any part is missing or damaged, do not attempt to assemble, install or operate the product.
2. Estimated assembly time: 30 minutes.
3. Tools required for assembly (not included): Phillips screwdriver, pliers, wire stripper, safety glasses, electrical tape, ladder.

Care and Maintenance

Shut off main power supply before cleaning product or changing light bulbs. To clean, wipe with damp cloth. Do not use abrasive cleaners or cleaners that contain alcohol.

Assembly Instructions

1

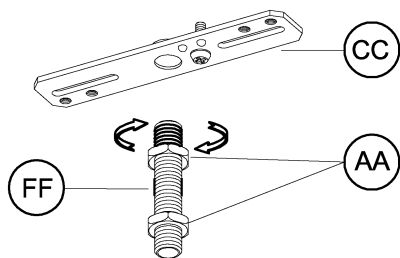

1. Screw threaded nipple (FF) into mounting strap (CC) several turns. Use one hex nut (AA) to secure parts tightly. Screw one hex nut (AA) onto threaded nipple (FF).

Hardware Used

	Hex nut		X2
	Nipple		X1
	Mounting strap		X1

2

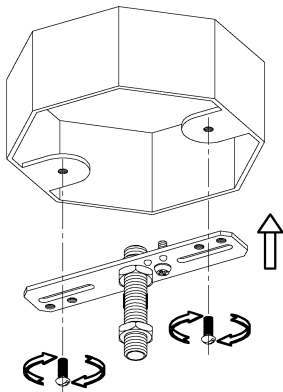

2. Attach assembled parts from Step 1 onto outlet box using the mounting screws supplied with the outlet box (not included).

ASSEMBLY INSTRUCTIONS



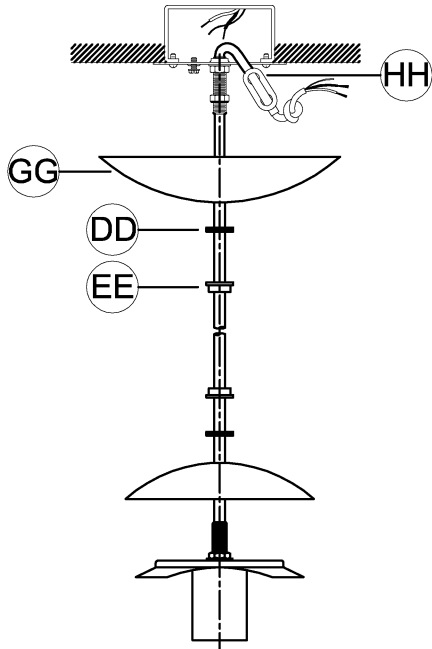

3



3. Pass the wires through the slip finial (EE)/ knurled nut (DD)/ canopy (GG)/ nipple and strain relief (HH). Tie a knot at the end of the fixture wire.

NOTE: During this step, you may choose to shorten the electrical/ ground wires.

Hardware Used

(DD) Knurled nut		X1
(EE) Slip finial		X1
(GG) Canopy		X1
(HH) Strain relief		X1

4

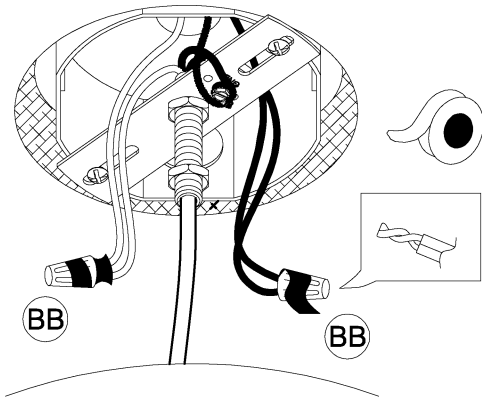

4. Strip 3/8" of insulation from the electrical wire ends. Using wire nuts (BB), connect white fixture wire to the white supply wire from the outlet box; connect the black fixture wire to the black supply wire.

Connect the fixture ground wire and supply ground wire using a wire nut or by fastening to the ground screw on the mounting strap. Push all wire connections into the outlet box.

(BB) Wire nut		X3
---------------	---	----

5

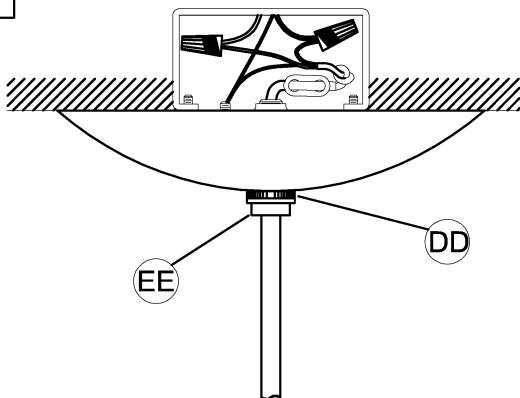

5. Tuck the wires into the outlet box and slip the canopy over the nipple. Thread the slip finial (EE) and knurled nut (DD) on the nipple to secure the canopy tightly to the ceiling.

ASSEMBLY INSTRUCTIONS

6

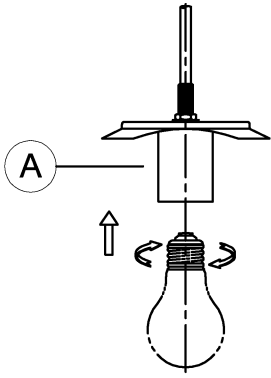

6. Screw lamp (not included) into fixture socket (A). Use 60-watt MAX incandescent medium base lamp, SBCFL or SBLED.

7

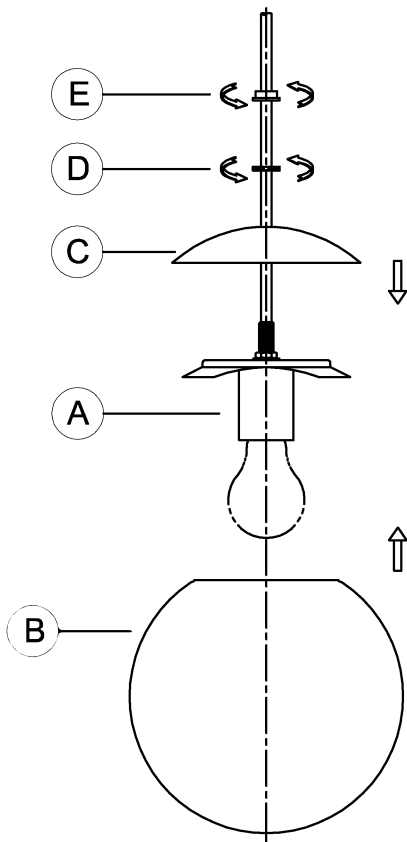

7. Attach glass globe (B) to fixture. Place glass cover (C) to fixture using knurled nut (D) and slip finial (E) to secure tightly.

a

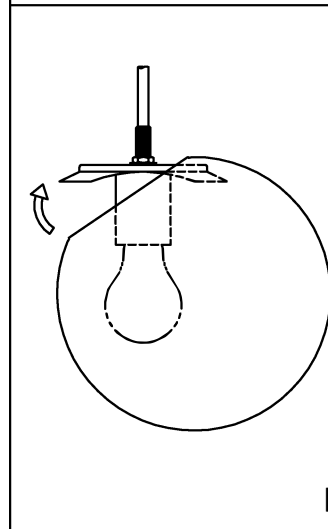

b

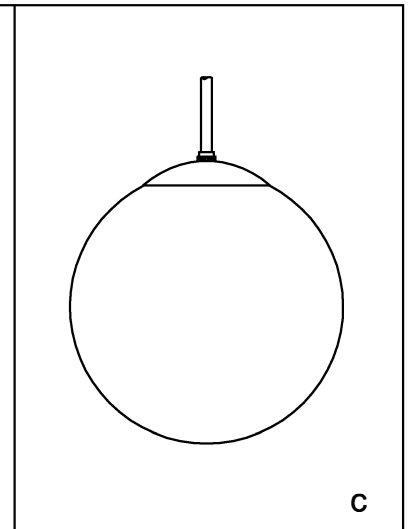

c



Questions?

Call our Customer Care Team at 1-855-303-4229

urban ambiance

www.urbanambiance.com