

# urban ambiance

Installation Instructions: **UHP4003**

PART	DESCRIPTION	QUANTITY	
A	Fixture	1	1
B	Knurl knob	3	3
C	Glass Shade	1	N/A
D	Metal shade	N/A	1
E	Canopy	1	1

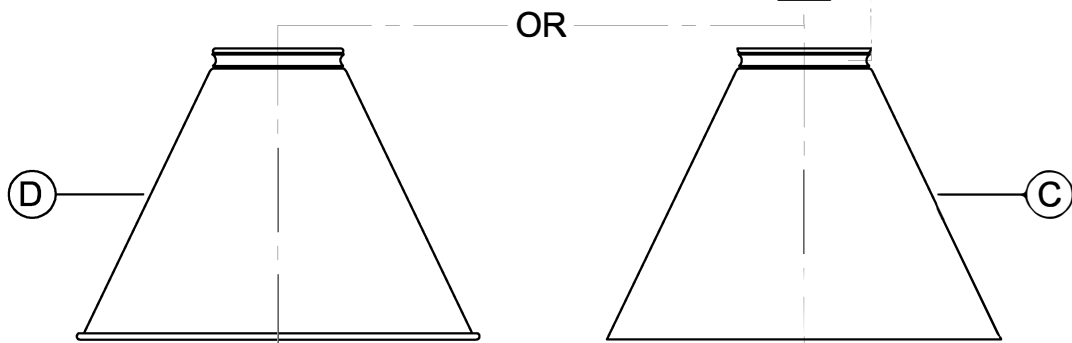
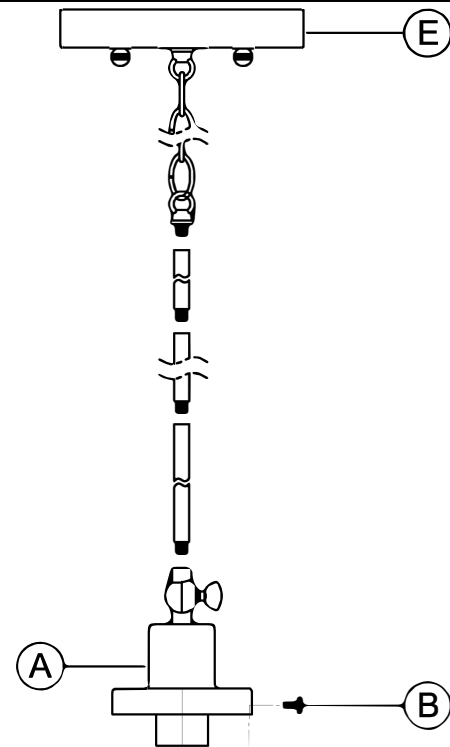

UHP4003/4/5/6 (Metal Shade) UHP3999/4000/1/2 (Glass Shade)

## HARDWARE CONTENTS (not actual size)

AA	BB	CC	DD	EE	FF	GG	HH	JJ	KK
Screw (#8-32) Qty:2	Wire nut Qty:3	Round mounting plate Qty:1	Hex nut (#8-32) Qty:2	Ball nut (#8-32) Qty:2	Chain (6 links) Qty:1	Chain loop (1/8IP) Qty:1	12" Pipe (1/8IP) Qty:4	6" Pipe (1/8IP) Qty:1	Nipple (1/8IP) Qty:6



### Questions?

Call our Customer Care Team at 1-855-303-4229

urban ambiance

[www.urbanambiance.com](http://www.urbanambiance.com)



## Safety Information

Please read and understand this entire manual before attempting to assemble, operate or install the product.

**CAUTION:** Read instructions carefully and turn electricity off at main circuit breaker panel before beginning installation.

**CAUTION:** Risk of fire. Min. 90°C supply conductors. Consult a qualified electrician to ensure correct branch circuit conductor.

**WARNING:** If any Special Control Devices are used with this fixture, follow instructions carefully to assure full compliance with N.E.C. requirements. If there are any questions, contact a qualified electrical contractor.

**CAUTION:** All glass is fragile. Use care when handling glass shades and bulbs.

## Preparation

1. Before beginning installation, make sure all parts are included using the contents diagrams from page 1. If any part is missing or damaged, do not attempt to assemble, install or operate the product.
2. Estimated assembly time: 30 minutes.
3. Tools required for assembly (not included): Phillips screwdriver, pliers, wire stripper, safety glasses, electrical tape, ladder.

## Care and Maintenance

Shut off main power supply before cleaning product or changing light bulbs. To clean, wipe with damp cloth. Do not use abrasive cleaners or cleaners that contain alcohol.

## Assembly Instructions

1

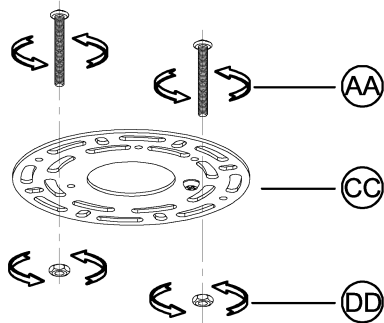

1. Screw screw (AA) onto round mounting plate (CC) and use hex nut (DD) to secure it tightly.

### Hardware Used

(AA)	Screw		X2
(CC)	Round mounting plate		X1
(DD)	Hex nut		X2

2

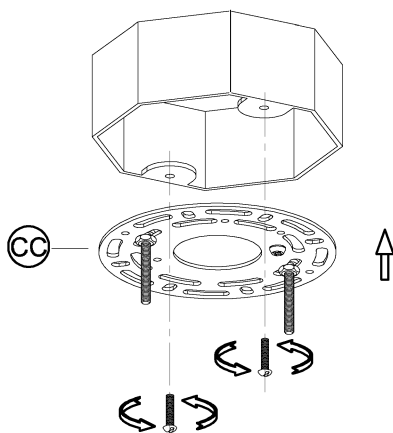

2. Attach assembled parts from step 1 onto outlet box using the mounting screws supplied with the outlet box (not included).



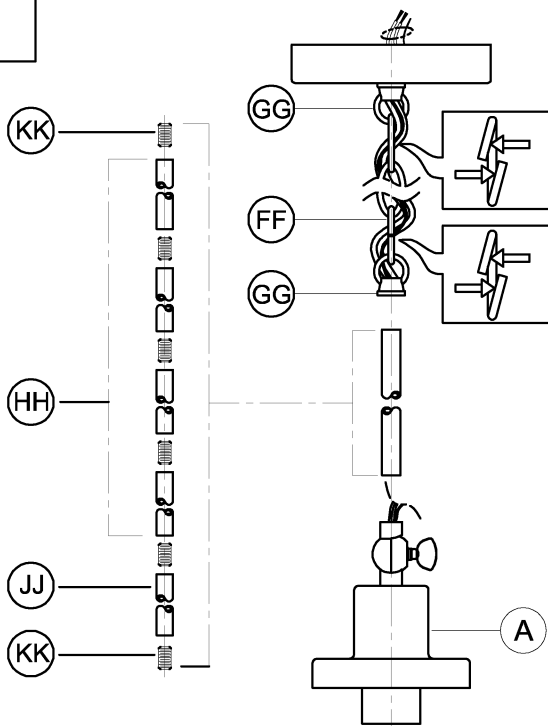

# Assembly Instructions

3

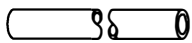
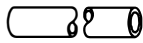

3. Pass the wires through the one pipe (JJ)/nipple (KK)/four pipes (HH) and chain loop (GG) to achieve overall desired length. Next attach pipes onto fixture (A) to secure tightly. Weave electric cord and ground wire through chain (FF) and canopy (D). Open two links of chain and attach both ends to chain loops (GG). Close the chain links.

NOTE: During this step, you may choose to shorten the chain and electrical/ground wires.

(FF) Chain		X1
(GG) Chain loop		X1
(HH) 12" Pipe		X4
(JJ) 6" Pipe		X1
(KK) Nipple		X6

4

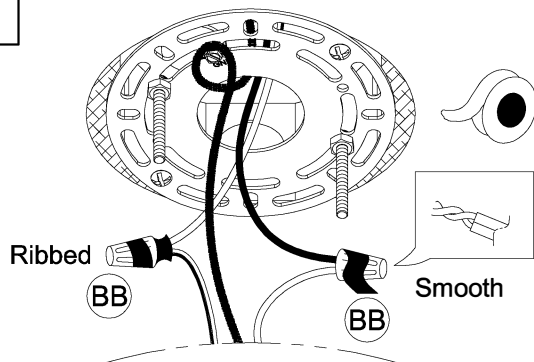

4. Strip 3/8" of insulation from the electrical wire ends. Using wire nuts (BB), connect RIBBED fixture wire to the WHITE supply wire from the outlet box; connect the SMOOTH fixture wire to the BLACK supply wire. Connect the fixture ground wire and supply ground wire using a wire nut or by fastening to the ground screw on the round mounting plate. Push all wire connections into the outlet box.

(BB) Wire nut		X3
---------------	---	----

5

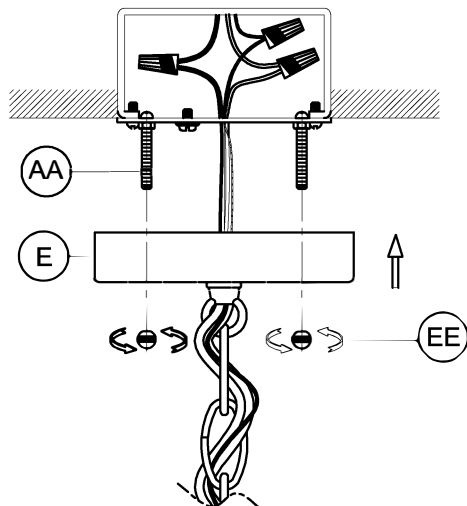

5. Secure the canopy (E) to screws (AA) use the ball nut (EE) to secure tightly.

(EE) Ball nut		X2
---------------	---	----

# Assembly Instructions

6

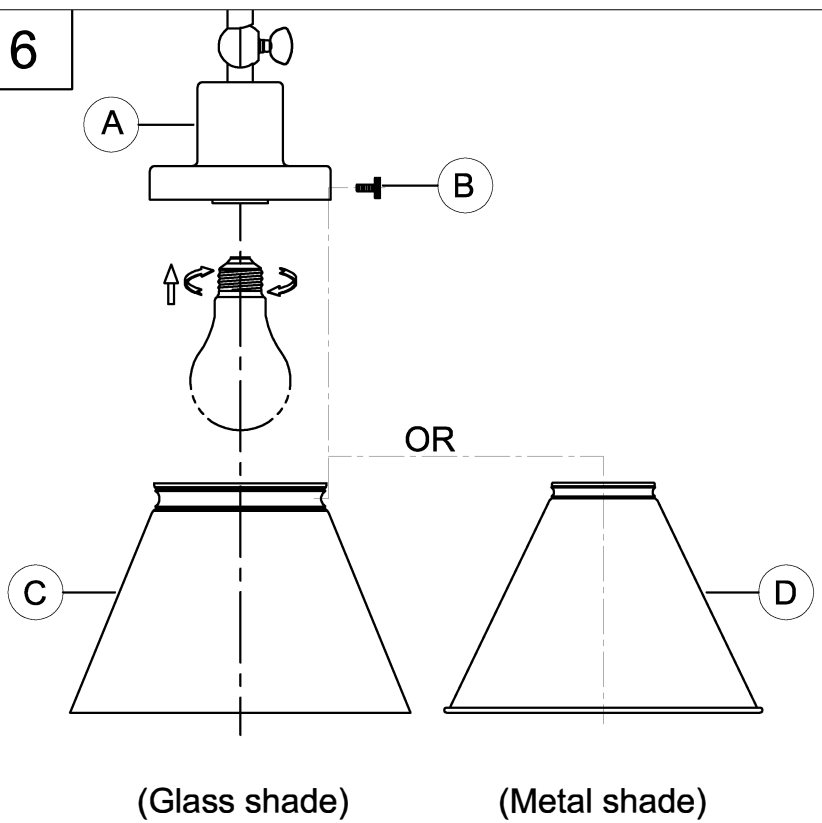

6. Screw lamp (not included) into the fixture socket. Use 100-watt MAX medium base lamp, SBCFL or SBLED.

Attach glass shade (C)/metal shade(D) to fixture (A) and use knurl knob (B) to secure tightly.



**Questions?**

Call our Customer Care Team at 1-855-303-4229

urban ambiance

[www.urbanambiance.com](http://www.urbanambiance.com)