

urban ambiance

Installation Instructions: **UHP3987**

PART	DESCRIPTION	QUANTITY
A	Fixture	1
B	Glass shade	1
C	Stem	1
D	Seat ring	1
E	Round tube	1
F	Hex nut	1
G	Seat ring	1
H	Coupling	1
J	Canopy	1

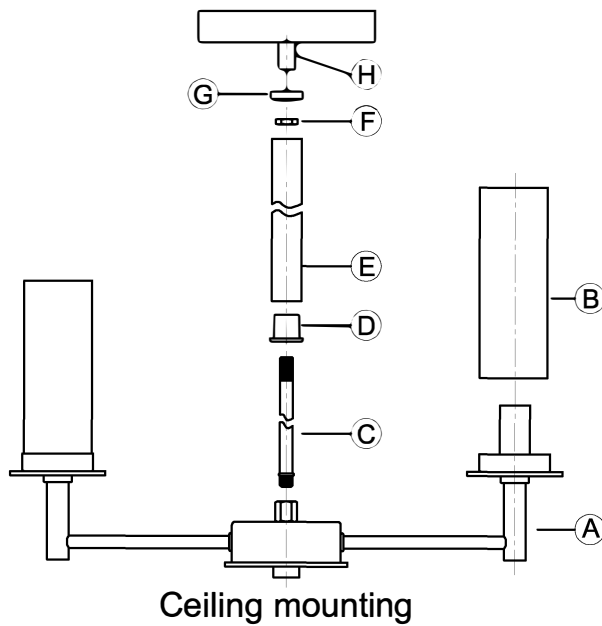
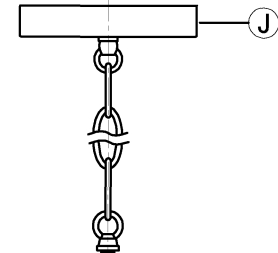
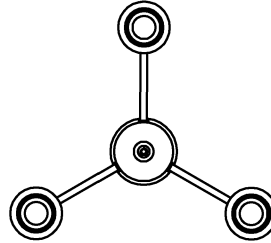

-OR-

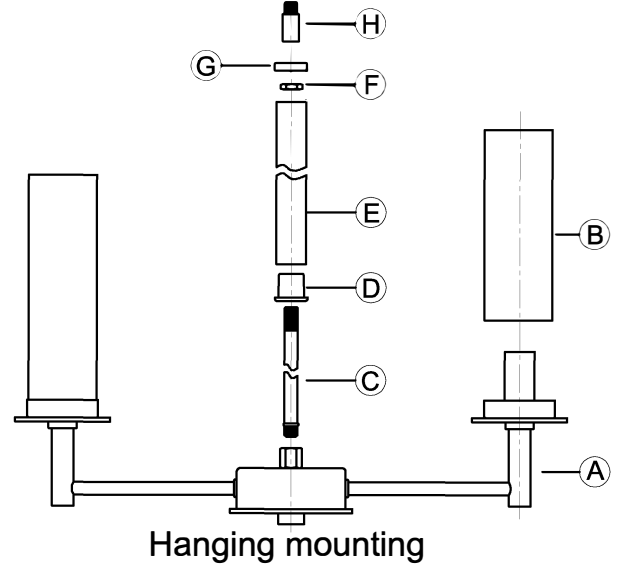

HARDWARE CONTENTS (not actual size)

AA	BB	CC	DD	EE	FF	GG	HH
Screw (#8-32) Qty:2	Wire nut Qty:3	Mounting plate Qty:1	Hex nut (#8-32) Qty:2	Cylinder nut (#8-32) Qty:2	Chain (48") Qty:1	Chain loop (1/8IP) Qty:2	Pipe (1/8IP) Qty:1



Questions?

Call our Customer Care Team at 1-855-303-4229

urban ambiance

www.urbanambiance.com



Safety Information

Please read and understand this entire manual before attempting to assemble, operate or install the product.

CAUTION: Read instructions carefully and turn electricity off at main circuit breaker panel before beginning installation.

CAUTION: Risk of fire. Min. 90°C supply conductors. Consult a qualified electrician to ensure correct branch circuit conductor.

WARNING: If any Special Control Devices are used with this fixture, follow instructions carefully to assure full compliance with N.E.C. requirements. If there are any questions, contact a qualified electrical contractor.

CAUTION: All glass is fragile. Use care when handling glass shades and bulbs.

Preparation

1. Before beginning installation, make sure all parts are included using the contents diagrams from page 1. If any part is missing or damaged, do not attempt to assemble, install or operate the product.
2. Estimated assembly time: 30 minutes.
3. Tools required for assembly (not included): Phillips screwdriver, pliers, wire stripper, safety glasses, electrical tape, ladder.

Care and Maintenance

Shut off main power supply before cleaning product or changing light bulbs. To clean, wipe with damp cloth. Do not use abrasive cleaners or cleaners that contain alcohol.





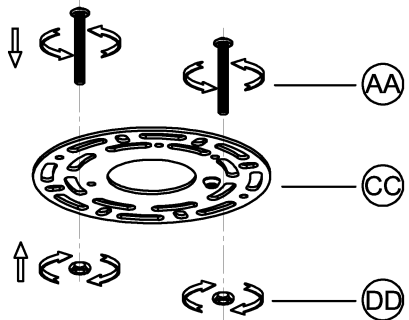

Assembly Instructions

1



1. Screw screw (AA) onto round mounting plate (CC) and use hex nut (DD) to secure it tightly.

Hardware Used

	Screw		X2
	Round mounting plate		X1
	Hex nut		X2

2

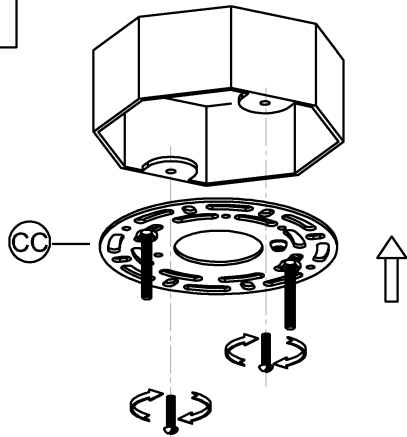

2. Attach assembled parts from Step 1 onto outlet box, using the mounting screws supplied with the outlet box (not included).

Ceiling Assembly Instructions

3

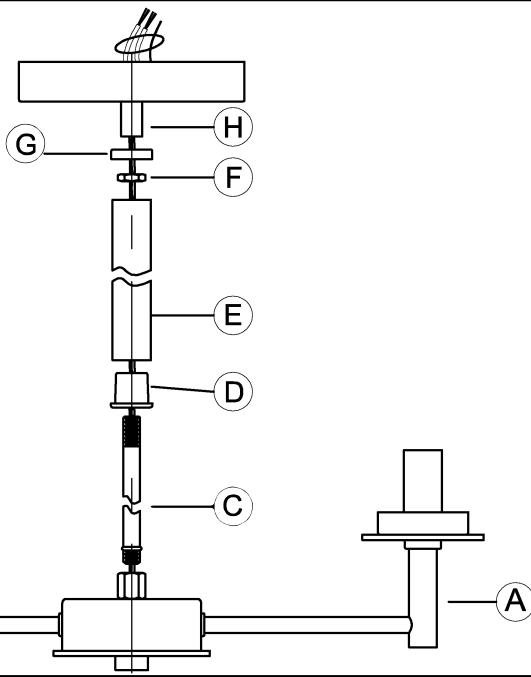

3. Pass the wires through the stem (C)/ seat ring (D) and round tube (E). Screw stem (C) into fixture (A). Attach seat ring (D) and round tube (E) onto stem (C). Pass the wires through the hex nut (F)/seat ring (G)/ coupling (H). Screw hex nut (F) onto stem (C), attach seat ring (G)/ coupling (H) onto stem (C) secure them tightly.

4

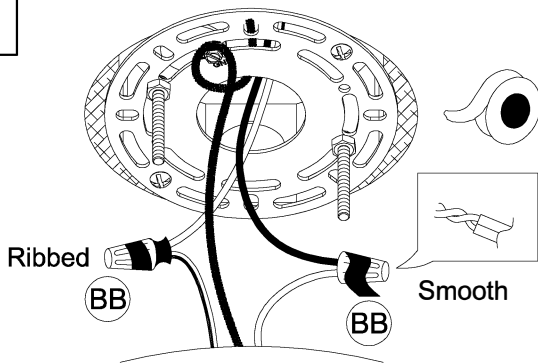

4. Strip 3/8" of insulation from the electrical wire ends. Using wire nuts (BB), connect RIBBED fixture wire to the WHITE supply wire from the outlet box; connect the SMOOTH fixture wire to the BLACK supply wire. Connect the fixture ground wire and supply ground wire using a wire nut or by fastening to the ground screw on the mounting plate. Push all wire connections into the outlet box.

(BB) Wire nut



X3

5

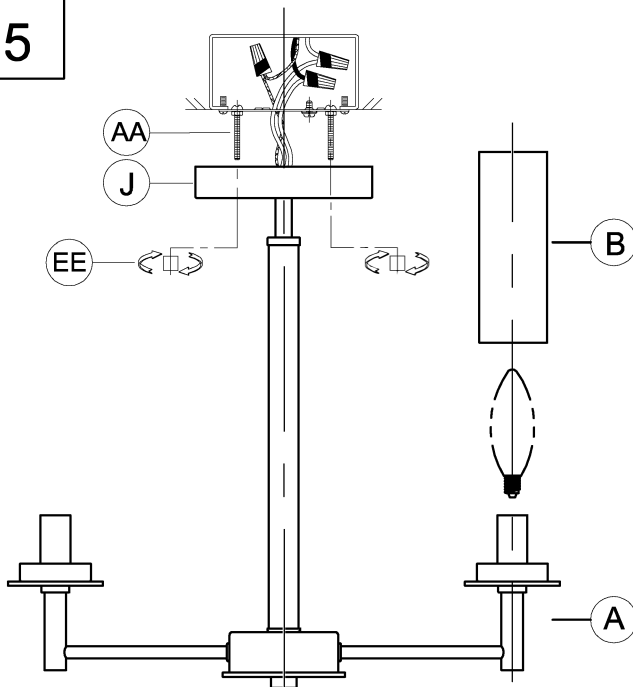

5. Attach fixture (A) to screws (AA) use cylinder nuts (EE) to Secure tightly.

(EE) Cylinder nuts



X2

Screw lamp (not included) into fixture socket (A). Use 60-watt MAX incandescent candelabra base lamp, SBCFL or SBLED.

Attach candle tube (B) to fixture (A).

Hanging Assembly Instructions

4

canopy parts

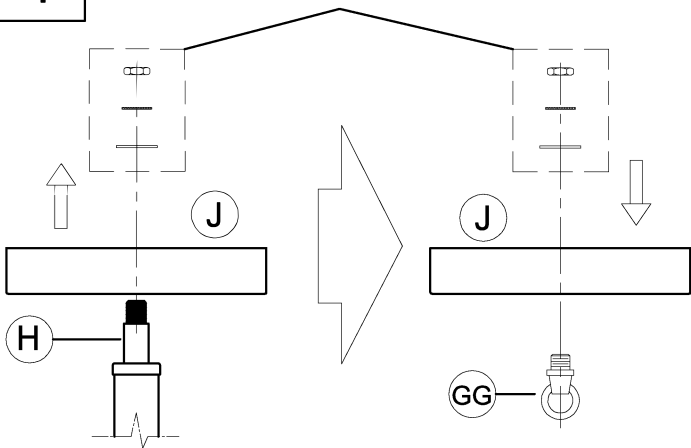

4. Remove existing canopy parts and canopy (J) from coupling (H).

Install canopy parts and chain loop (GG) into canopy (J). Secure tightly.

Ⓞ(GG) Chain loop



X1

5

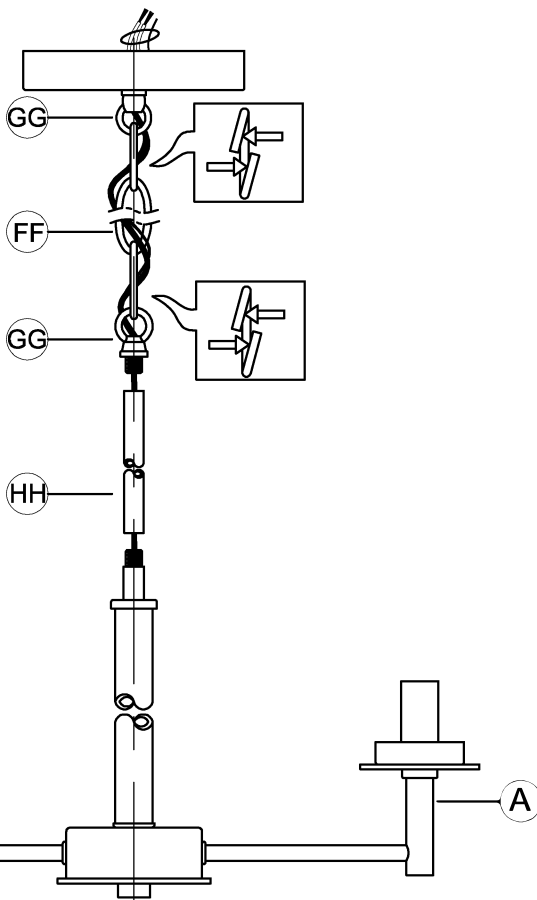

5. Pass the wires through pipe (HH) / chain loop (GG). attach chain loop (GG) to fixture (A) use pipe (HH) to secure tightly.

Weave wires through chain (FF) and chain loop (GG). Open two links of chain and attach both ends to chain loops. Close the chain links.

Pass the wires through the chain loop, canopy, mounting plate.

NOTE: During this step, you may choose to shorten the chain and electrical/ground wires.

Hardware Used

Ⓞ(FF) Chain



X1

Ⓞ(GG) Chain loop



X1

Ⓞ(HH) Pipe

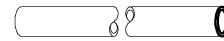

X1

Hanging Assembly Instructions

6

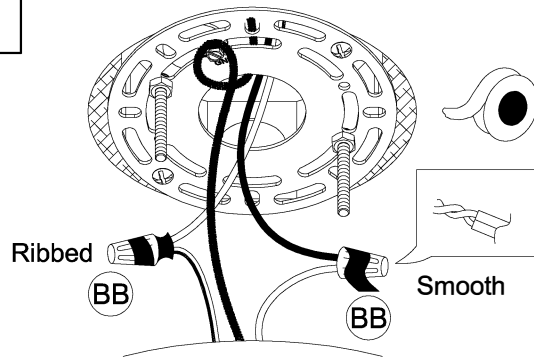

6. Strip 3/8" of insulation from the electrical wire ends. Using wire nuts (BB), connect RIBBED fixture wire to the WHITE supply wire from the outlet box; connect the SMOOTH fixture wire to the BLACK supply wire.

Connect the fixture ground wire and supply ground wire using a wire nut or by fastening to the ground screw on the round mounting plate. Push all wire connections into the outlet box.



Wire nut



X3

7

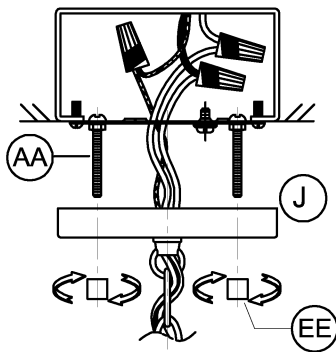

7. Secure the canopy (J) to screws (AA) use the two cylinder nuts (EE). Tighten securely.



Cylinder nut



X2

8

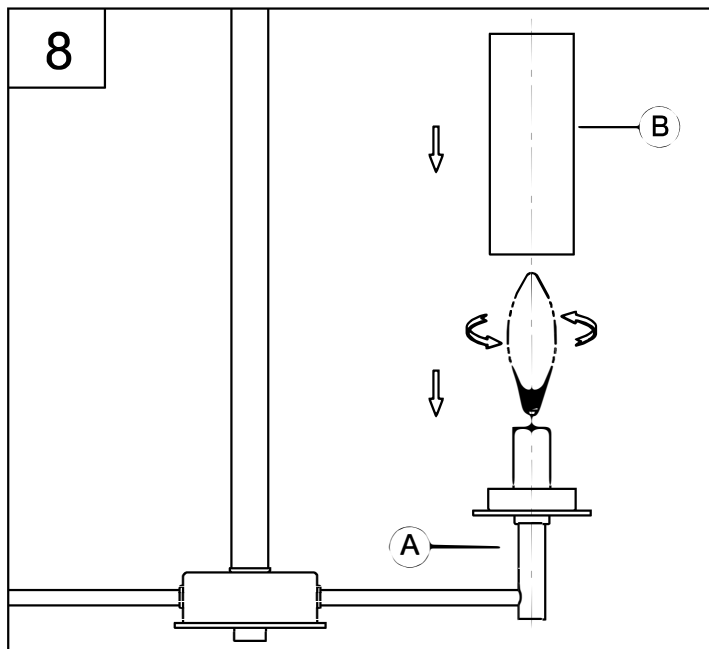

8. Screw lamp (not included) into fixture socket (A). Use 60-watt MAX incandescent candelabra base, SBCFL or SBLED.

Place glass shades (B) onto fixture (A).



Questions?

Call our Customer Care Team at 1-855-303-4229

urban ambiance

www.urbanambiance.com