

urban ambiance

Installation Instructions: **UHP3983**

PART	DESCRIPTION	QUANTITY
A	Fixture	1
B	Glass shade	1
C	Socket ring	1

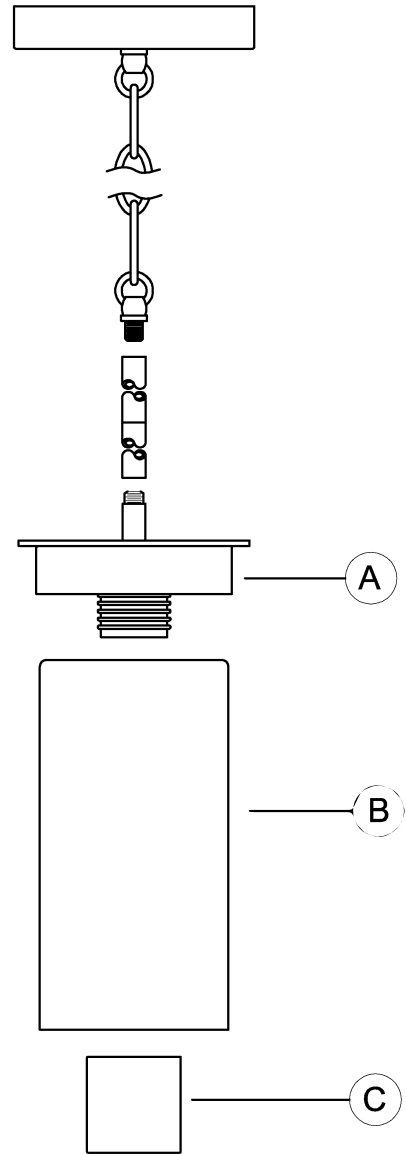

HARDWARE CONTENTS (not actual size)

AA	BB	CC	DD	EE	FF	GG	HH	JJ	KK
Screw (#8-32)	Wire nut	Mounting plate	Hex nut (#8-32)	Cylinder nut (#8-32)	Chain (6 LINKS)	Chain loop (1/8IP)	12" Pipe (1/8IP)	6" Pipe (1/8IP)	Nipple (1/8IP)
Qty:2	Qty:3	Qty:1	Qty:2	Qty:2	Qty:1	Qty:1	Qty:4	Qty:1	Qty:4



Questions?

Call our Customer Care Team at 1-855-303-4229

urban ambiance

www.urbanambiance.com



Safety Information

Please read and understand this entire manual before attempting to assemble, operate or install the product.

CAUTION: Read instructions carefully and turn electricity off at main circuit breaker panel before beginning installation.

CAUTION: Risk of fire. Min. 90°C supply conductors. Consult a qualified electrician to ensure correct branch circuit conductor.

WARNING: If any Special Control Devices are used with this fixture, follow instructions carefully to assure full compliance with N.E.C. requirements. If there are any questions, contact a qualified electrical contractor.

CAUTION: All glass is fragile. Use care when handling glass shades and bulbs.

Preparation

1. Before beginning installation, make sure all parts are included using the contents diagrams from page 1. If any part is missing or damaged, do not attempt to assemble, install or operate the product.
2. Estimated assembly time: 30 minutes.
3. Tools required for assembly (not included): Phillips screwdriver, pliers, wire stripper, safety glasses, electrical tape, ladder.

Care and Maintenance

Shut off main power supply before cleaning product or changing light bulbs. To clean, wipe with damp cloth. Do not use abrasive cleaners or cleaners that contain alcohol.

Assembly Instructions

1

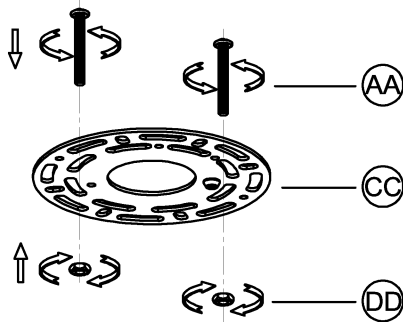

1. Screw screw (AA) onto round mounting plate (CC) and use hex nut (DD) to secure it tightly.

Hardware Used

(AA)	Screw		X2
(CC)	Round mounting plate		X1
(DD)	Hex nut		X2

2

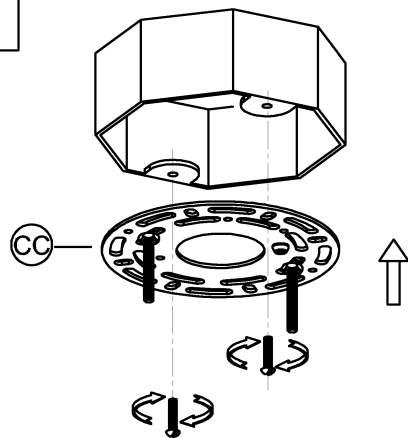

2. Attach assembled parts from step 1 onto outlet box, using the mounting screws supplied with the outlet box (not included).

ASSEMBLY INSTRUCTIONS

3

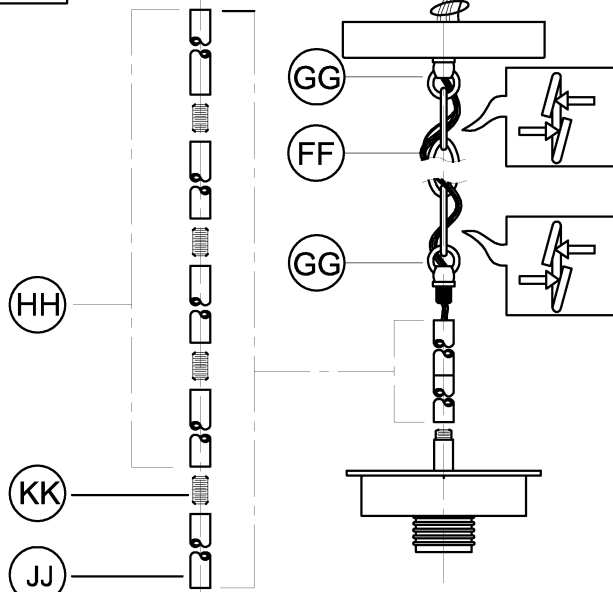





3. Pass the wires through the nipple (KK)/one pipe (JJ)/ four pipe (HH) to achieve overall desired length. Next attach pipe onto fixture using nipple (KK). Secure tightly.

Weave electric cord and ground wire through chain (FF) and chain loop (GG). Open two links of chain and attach both ends to chain loops (GG). Close the chain links. Pass the wires through the chain loop, canopy, mounting plate.

NOTE: During this step, you may choose to shorten the chain and electrical/ground wires.

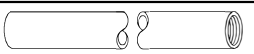
Hardware Used

(FF)	Chain		X1
(GG)	Chain loop		X1
(HH)	12" Pipe		X4
(JJ)	6" Pipe		X1
(KK)	Nipple		X4

4

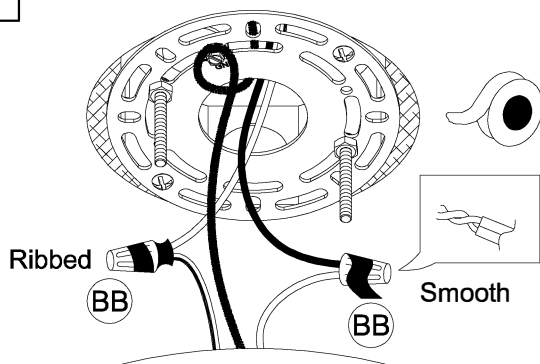

4. Strip 3/8" of insulation from the electrical wire ends. Using wire nuts (BB), connect RIBBED fixture wire to the WHITE supply wire from the outlet box; connect the SMOOTH fixture wire to the BLACK supply wire.

Connect the fixture ground wire and supply ground wire using a wire nut or by fastening to the ground screw on the round mounting plate. Push all wire connections into the outlet box.

(BB)	Wire nut		X3
------	----------	---	----

5

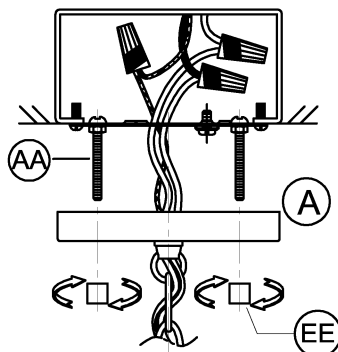

5. Secure the canopy to screws (AA) using the two cylinder nuts (EE). Tighten securely.

(EE)	Cylinder nut		X2
------	--------------	---	----

ASSEMBLY INSTRUCTIONS

6

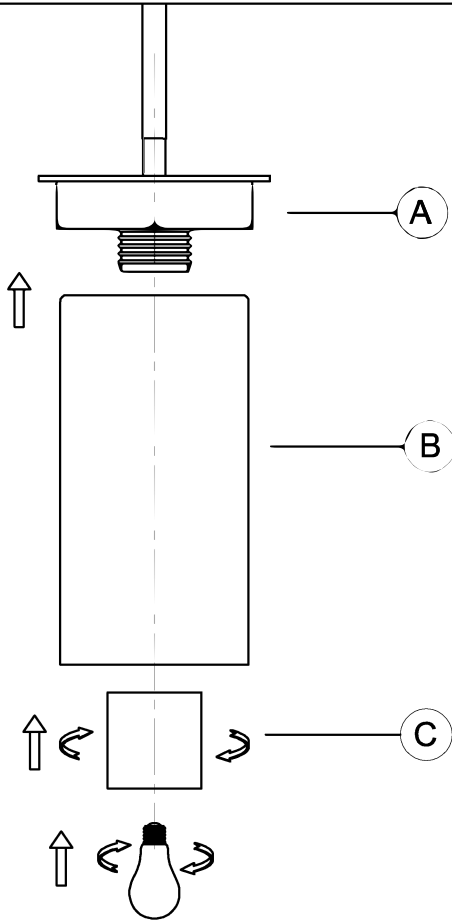

6. Place glass shade (B) into fixture (A) using socket ring (C) to secure it tightly. Screw lamp (not included) into fixture socket. Use 60-watt MAX incandescent medium base lamp, SBCFL or SBLED.



Questions?

Call our Customer Care Team at 1-855-303-4229

urban ambiance

www.urbanambiance.com