

urban ambiance

Installation Instructions: **UHP3979**

PART	DESCRIPTION	QUANTITY
A	Fixture	1
B	Chain loop	1
C	Candle cover	8
D	Flat tube ring	1
E	Finial	4

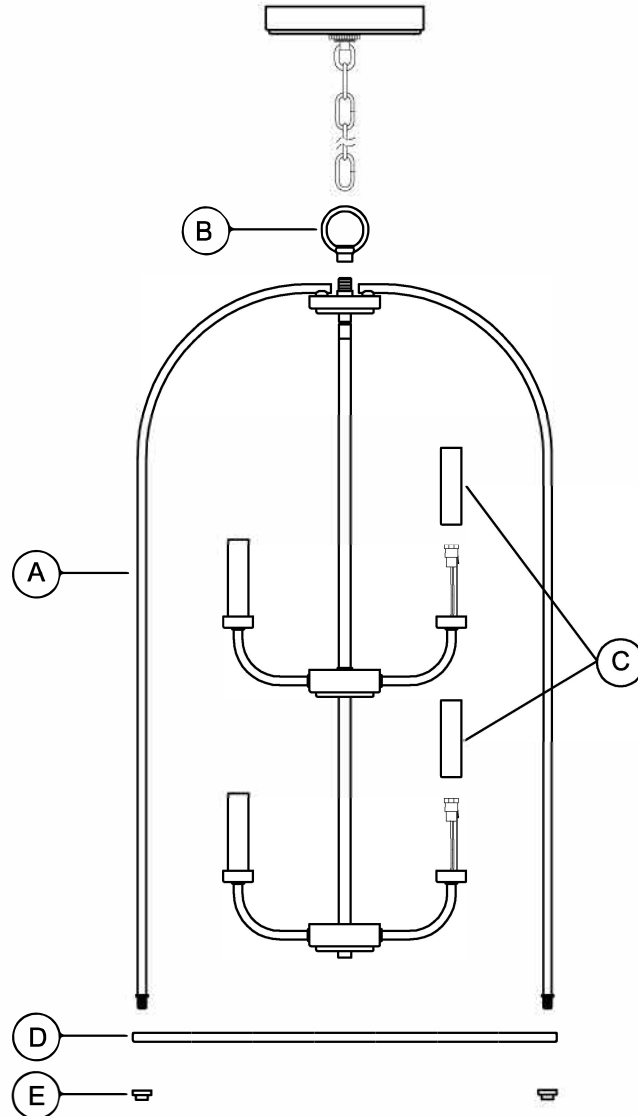

HARDWARE CONTENTS (not actual size)

AA	BB	CC	DD	EE	FF	GG	HH
Wire nut	Mounting strap (1/8IP)	Nipple (1/8IP)	Hex nut (1/8IP)	Screw collar	Chain holder (1/8IP)	Canopy	72" Chain
Qty:3	Qty:1	Qty:1	Qty:2	Qty:1	Qty:1	Qty:1	Qty:1



Questions?

Call our Customer Care Team at 1-855-303-4229

urban ambiance

www.urbanambiance.com



Safety Information

Please read and understand this entire manual before attempting to assemble, operate or install the product.

CAUTION: Read instructions carefully and turn electricity off at main circuit breaker panel before beginning installation.

CAUTION: Risk of fire. Min. 90°C supply conductors. Consult a qualified electrician to ensure correct branch circuit conductor.

WARNING: If any Special Control Devices are used with this fixture, follow instructions carefully to assure full compliance with N.E.C. requirements. If there are any questions, contact a qualified electrical contractor.

CAUTION: All glass is fragile. Use care when handling glass shades and bulbs.

Preparation

1. Before beginning installation, make sure all parts are included using the contents diagrams from page 1. If any part is missing or damaged, do not attempt to assemble, install or operate the product.
2. Estimated assembly time: 30 minutes.
3. Tools required for assembly (not included): Phillips screwdriver, pliers, wire stripper, safety glasses, electrical tape, ladder.

Care and Maintenance

Shut off main power supply before cleaning product or changing light bulbs. To clean, wipe with damp cloth. Do not use abrasive cleaners or cleaners that contain alcohol.

Assembly Instructions

1

The diagram shows the assembly of the mounting hardware. Part BB is a long metal mounting strap with two screw holes. Part CC is a threaded nipple. Part DD is a hex nut. Part FF is a chain holder. Arrows indicate the assembly sequence: first, the nipple (CC) is inserted into the mounting strap (BB). Then, the hex nut (DD) is threaded onto the nipple. Finally, the chain holder (FF) is attached to the end of the nipple.

1. Screw threaded nipple (CC) into mounting strap (BB) several turns. Use one hex nut (DD) to secure parts tightly. Thread one hex nut (DD) and chain holder (FF) onto threaded nipple (CC). Tighten the hex nut against the top of the screw collar loop.

Hardware Used

(BB)	1/8IP Mounting strap		X1
(CC)	Nipple		X1
(DD)	Hex nut		X2
(FF)	Chain holder		X1

2

The diagram shows the assembled hardware from step 1 being attached to the bottom of a hexagonal outlet box. An upward-pointing arrow indicates the direction of assembly. Screws are shown being inserted through the mounting holes in the outlet box into the mounting strap (BB).

2. Attach assembled parts from step 1 onto outlet box using the mounting screws supplied with the outlet box (not included).

Assembly Instructions

3

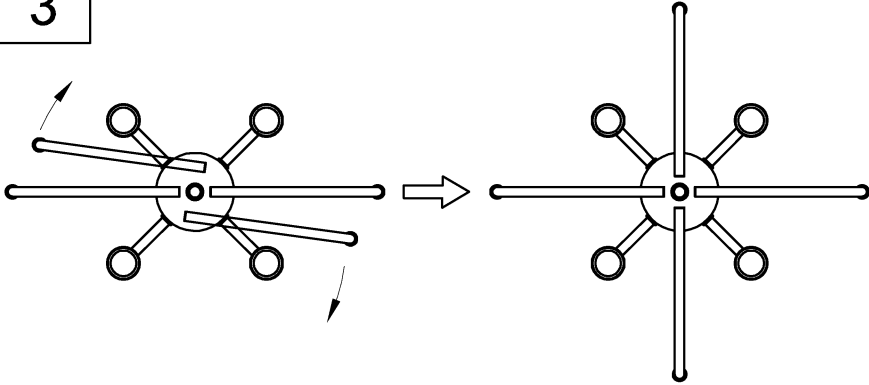

3. Adjust the round arms.

4

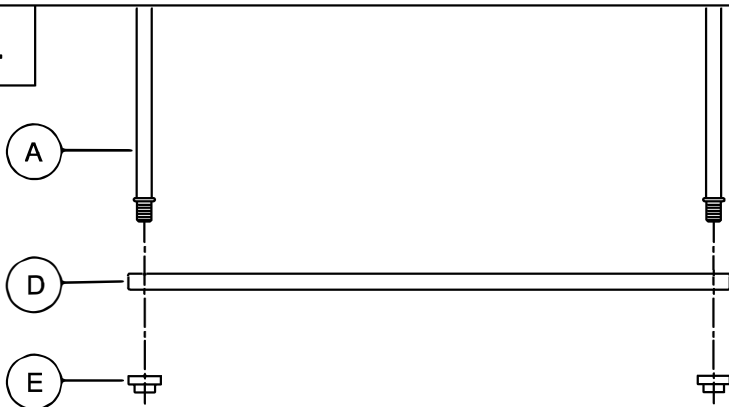

4. Attach flat tube ring (D) to fixture (A), using finial (E) to secure tightly.

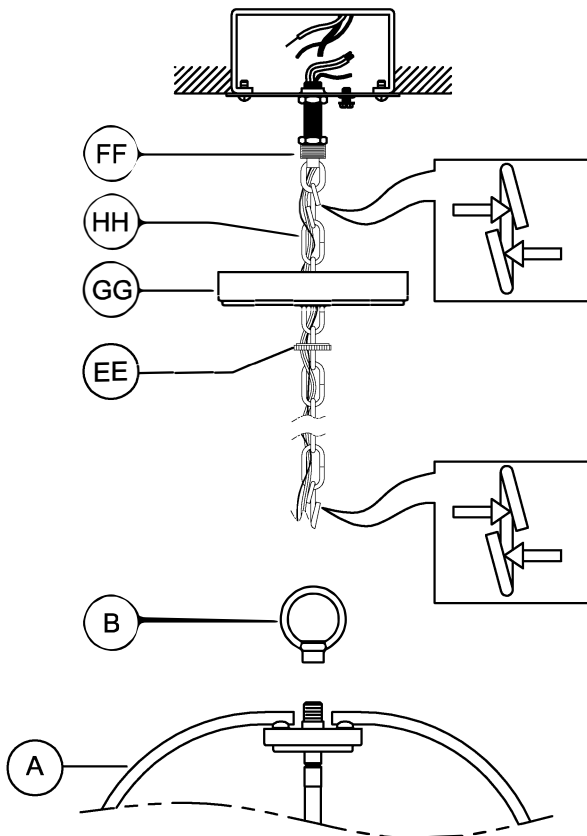

5



5. Pass the wires through the chain loop (B) and secure tightly onto fixture (A). Weave wires through chain (HH). Pass wires through screw collar (EE) and canopy (GG). Open two links of chain and attach one end to chain loop (B) and the other end to the chain holder (FF). Close the chain links. Pass the wires through the chain holder/ threaded nipple/crossbar.

NOTE: During this step, you may choose to shorten the chain and electrical/ground wires.

Hardware Used

EE	Screw collar		X1
GG	Canopy		X1
HH	72" Chain		X1

Assembly Instructions

6

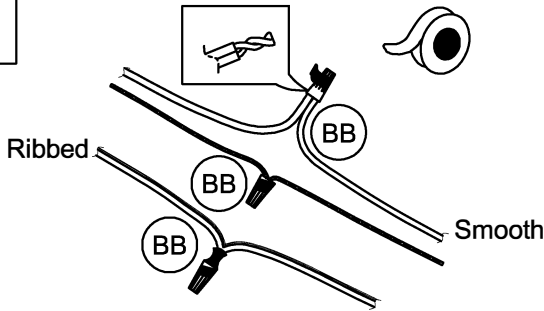

6. Strip 3/8" of insulation from the electrical wire ends. Using wire nuts (BB), connect RIBBED fixture wire to the WHITE supply wire from the outlet box; connect the SMOOTH fixture wire to the BLACK supply wire.

Connect the fixture ground wire and supply ground wire using a wire nut or by fastening to the ground screw on the mounting strap. Push all wire connections into the outlet box.

(BB) Wire nut  X3

7

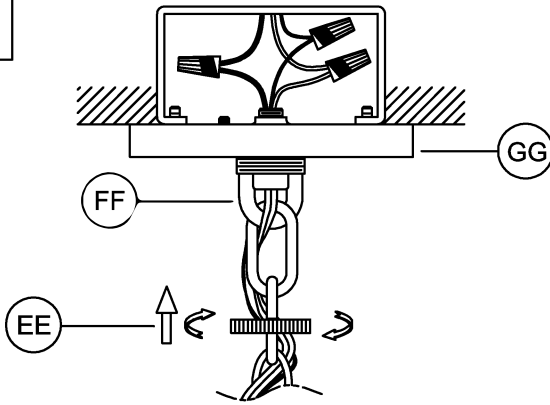

7. Slip the canopy (GG) over the chain holder (FF) Thread the screw collar (EE) onto the chain holder to secure the canopy tightly to the ceiling.

8

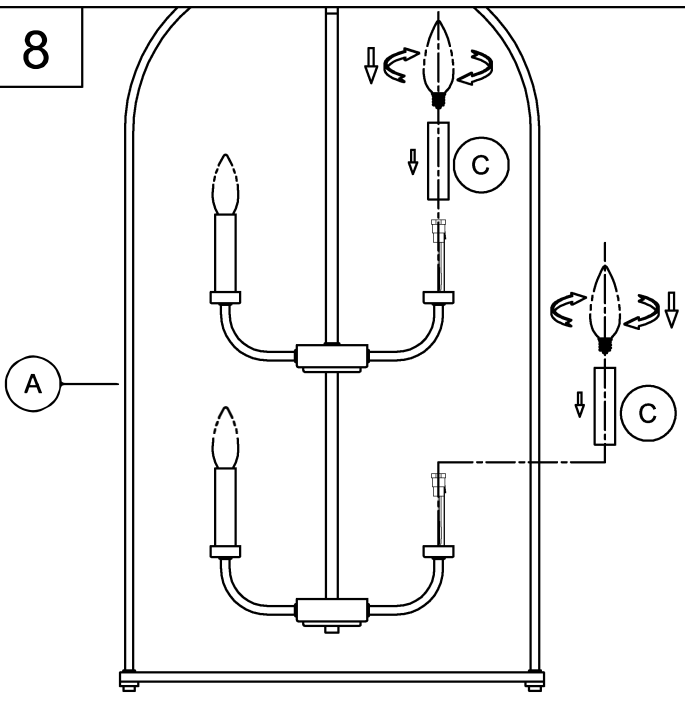

8. Attach candle cover (C) to fixture (A) .

Screw lamp (not included) into fixture socket. Use 60-watt MAX incandescent candelabra base lamp, SBCFL or SBLED.



Questions?

Call our Customer Care Team at 1-855-303-4229

urban ambiance

www.urbanambiance.com