

urban ambiance

Installation Instructions: UHP3951

PART	DESCRIPTION	QUANTITY
A	Fixture	1
B	Candle tube	5
C	Pipe	2
D	Chain loop	2
E	Canopy	1

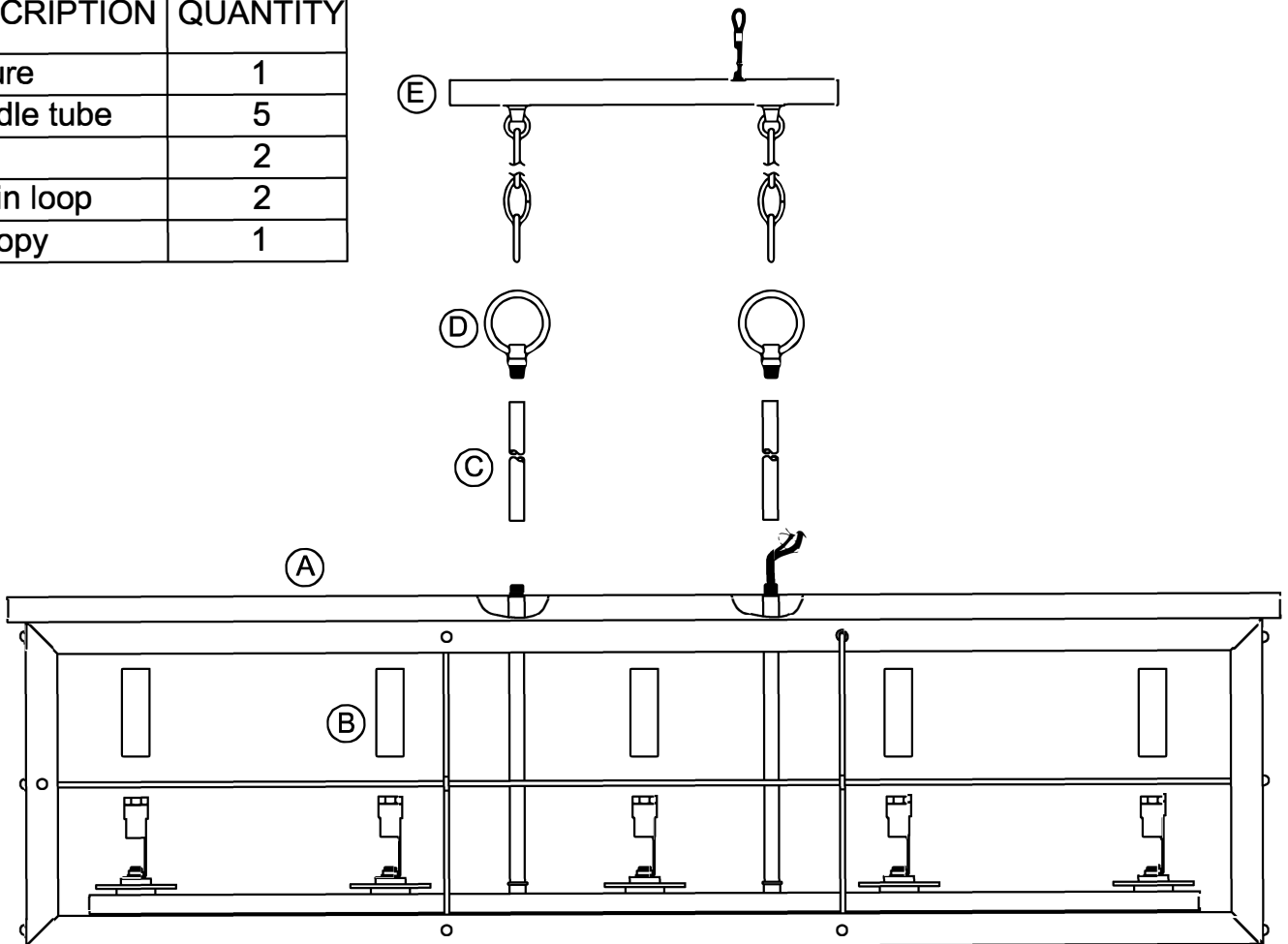

HARDWARE CONTENTS (not actual size)

AA	BB	CC	DD	EE	FF	GG	HH	JJ
Nipple (1/8IP)	Wire connector	Mounting strap (1/8IP)	Hex nut (1/8IP)	Screw (#8)	Flat washer	Finial (1/8IP)	Chain (72")	Quick link
Qty:1	Qty:3	Qty:1	Qty:1	Qty:1	Qty:1	Qty:1	Qty:2	Qty:2



Questions?

Call our Customer Care Team at 1-855-303-4229

urban ambiance

www.urbanambiance.com



SAFETY INFORMATION

Please read and understand this entire manual before attempting to assemble, operate or install the product.
CAUTION: Read instructions carefully and turn electricity off at main circuit breaker panel before beginning installation.

CAUTION: Risk of fire. Min. 90°C supply conductors. Consult a qualified electrician to ensure correct branch circuit conductor

WARNING: If any Special Control Devices are used with this Fixture, follow instructions carefully to assure full compliance with N.E.C. requirements. If there are any questions, contact a qualified electrical contractor.

CAUTION: All glass is fragile, use care when handling glass shades and bulbs.

PREPARATION

1. Before beginning installation, make sure all parts are included using the contents diagrams from page 1. If any part is missing or damage, do not attempt to assemble, install or operate the product.
2. Estimated assembly time: 30 minutes.
3. Tools required for assembly (not included): Phillips screwdriver, pliers, wire stripper, safety glasses, electrical tape, ladder, drill.

CARE AND MAINTENANCE

Shut off main power supply before cleaning product or changing light bulbs. To clean, wipe with damp cloth. Do not use abrasive cleaners or cleaners that contain alcohol.

ASSEMBLY INSTRUCTIONS

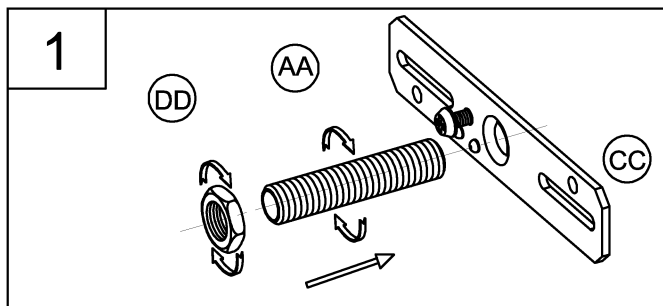

1. Screw nipple (AA) and hex nut (DD) onto mounting strap (CC)

(AA)	Nipple		X1
(DD)	Hex nut		X1
(CC)	Mounting strap		X1

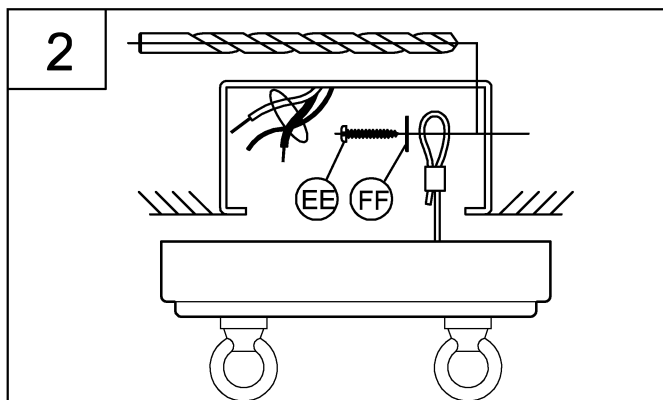

2. Use a drill with a #29 (Ø.136) (3.5mm) bit to create mounting holes in the outlet box. Next Attach flat washer (FF) and support cable onto outlet box using screw (EE) to secure tightly.

Hardware Used

(EE)	Screw		X1
(FF)	Flat washer		X1

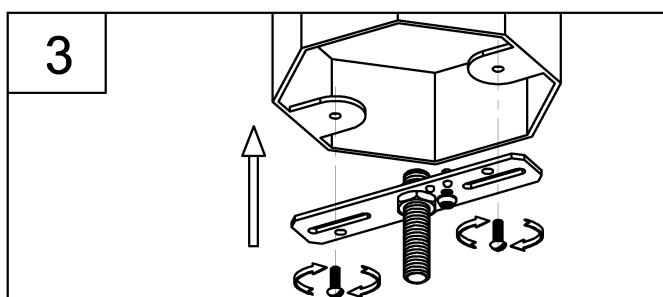

3. Attach assembled parts from Step 1 onto junction box using the mounting screws supplied with the outlet box (not included).

ASSEMBLY INSTRUCTIONS

4. Pass the wires through pipe(C) and chain loop(D), attach pipe(C) onto fixture(A). Secure tightly. Weave wires through chain (HH) and canopy (E). Open one link of chain and attach to chain loop(D). Close the chain link. Attach the other end to the canopy(E) using the quick link (JJ).

Repeat this step for the second chain set without the wires.

NOTE: During this step, you may choose to shorten the chain and electrical/ground wires.

- (HH) Chain X2
- (JJ) Quick link X2

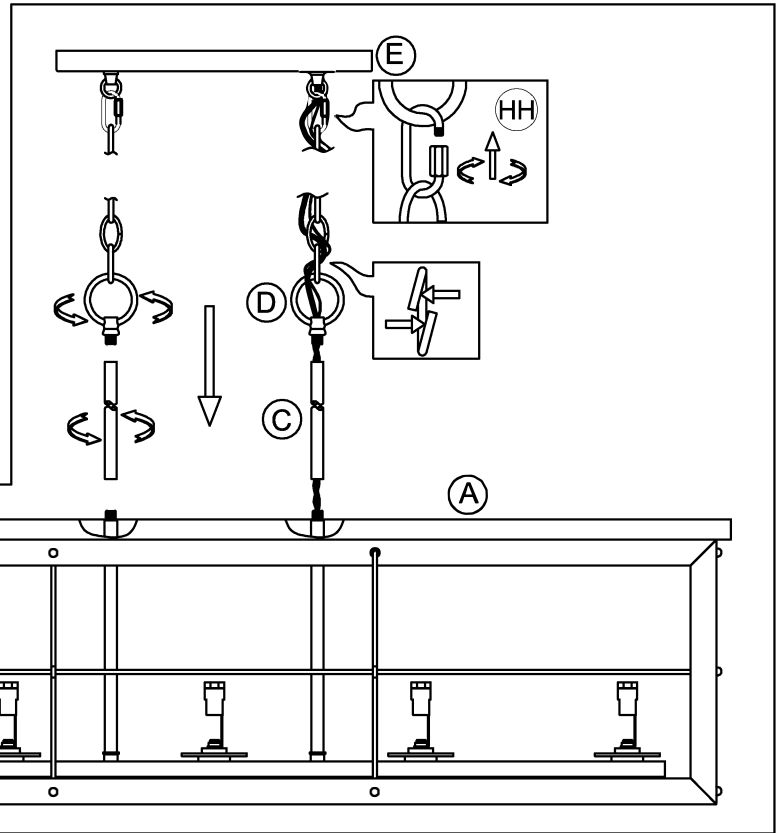

4

5. Strip $\frac{3}{8}$ " of insulation from the electrical wire ends. Using wire connector (BB), connect RIBBED fixture wire to the WHITE supply wire from the outlet box; connect the SMOOTH fixture wire to the BLACK supply wire.

Connect the fixture ground wire and supply ground wire using a wire nut or by fastening to the ground screw on the mounting strap. Push all wire connections into the outlet box.

- (BB) Wire connector X3

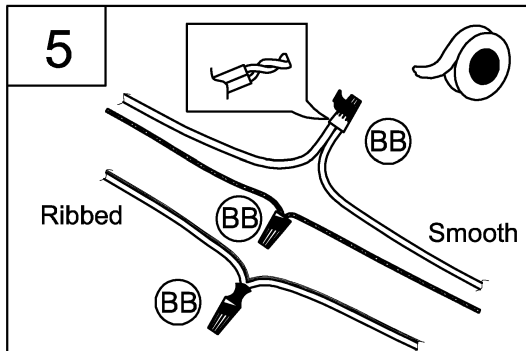

5

6. Attach canopy (E) onto nipple (AA) and use finial (GG) to secure the canopy tightly to the ceiling.

- (GG) Finial X1

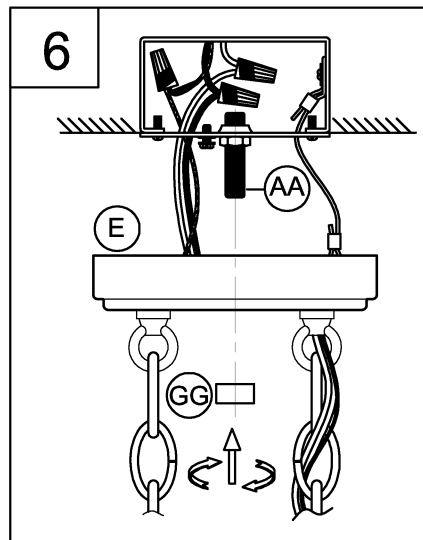

6

7. Attach candle tube(B) into fixture socket(A). Screw lamp (not included) into fixture socket. Use 60-watt MAX incandescent candelabra base lamp, SBCFL or SBLED.

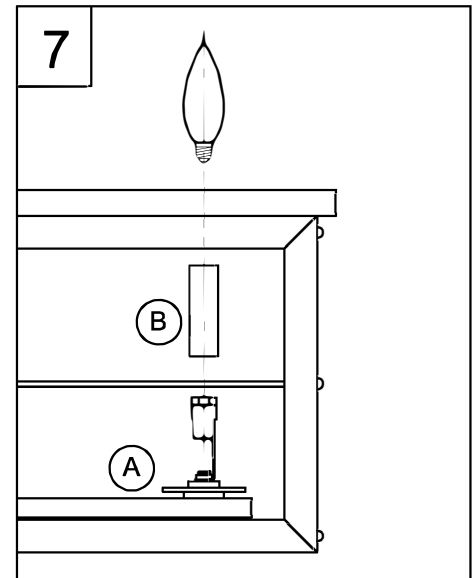

7



Questions?

Call our Customer Care Team at 1-855-303-4229

urban ambiance

www.urbanambiance.com