

# urban ambiance

Installation Instructions: **UHP3931**

PART	DESCRIPTION	QUANTITY	
		UHP3930	UHP3931
A	Fixture	1	1
B	Frame	1	1
C	Rectangle ring	1	1
D	Screw	5	6
E	Finial	5	6
F	Candle tube	4	5

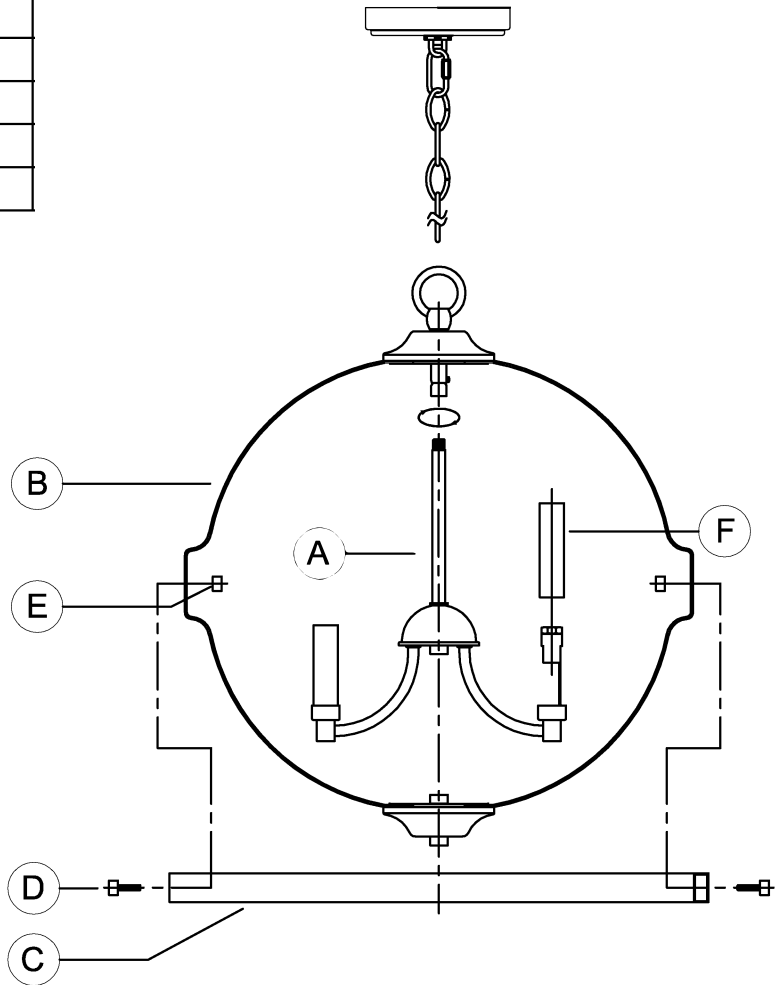
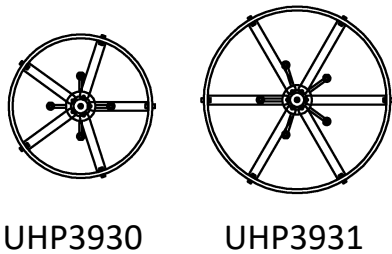

## HARDWARE CONTENTS (not actual size)

AA	BB	CC	DD	EE	FF	GG	HH	JJ	KK
Hex nut	Wire nut	1/8IP Mounting strap	Screw collar	Chain holder	Nipple	Chain	Quick-link	Chain loop	Canopy
Qty:2	Qty:3	Qty:1	Qty:1	Qty:1	Qty:1	Qty:1	Qty:1	Qty:1	Qty:1



### Questions?

Call our Customer Care Team at 1-855-303-4229

urban ambiance

[www.urbanambiance.com](http://www.urbanambiance.com)



## Safety Information

Please read and understand this entire manual before attempting to assemble, operate or install the product.

**CAUTION:** Read instructions carefully and turn electricity off at main circuit breaker panel before beginning installation.

**CAUTION:** Risk of fire. Min. 90°C supply conductors. Consult a qualified electrician to ensure correct branch circuit conductor.

**WARNING:** If any Special Control Devices are used with this fixture, follow instructions carefully to assure full compliance with N.E.C. requirements. If there are any questions, contact a qualified electrical contractor.

**CAUTION:** All glass is fragile. Use care when handling glass shades and bulbs.

## Preparation

1. Before beginning installation, make sure all parts are included using the contents diagrams from page 1. If any part is missing or damaged, do not attempt to assemble, install or operate the product.
2. Estimated assembly time: 30 minutes.
3. Tools required for assembly (not included): Phillips screwdriver, pliers, wire stripper, safety glasses, electrical tape, ladder.

## Care and Maintenance

Shut off main power supply before cleaning product or changing light bulbs. To clean, wipe with damp cloth. Do not use abrasive cleaners or cleaners that contain alcohol.

## Assembly Instructions

1

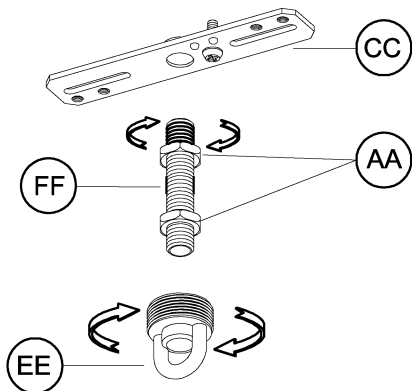

1. Screw threaded nipple (FF) into mounting strap (CC) several turns. Use one hex nut (AA) to secure parts tightly. Screw one hex nut (AA) and chain holder (EE) onto threaded nipple (FF). Tighten the hex nut against the top of the chain holder.

### Hardware Used

	Hex nut		X2
	Nipple		X1
	1/8IP Mounting strap		X1
	Chain holder		X1

2

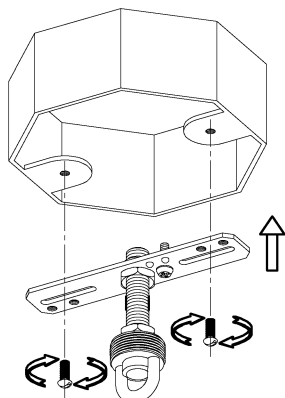

2. Attach assembled parts from Step 1 onto outlet box using the mounting screws supplied with the outlet box (not included).

# ASSEMBLY INSTRUCTIONS

3

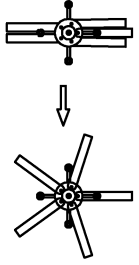

UHP3930

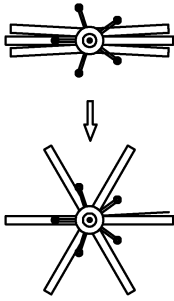

UHP3931

3. Equally adjust the frame by carefully turning them out from the center.

4

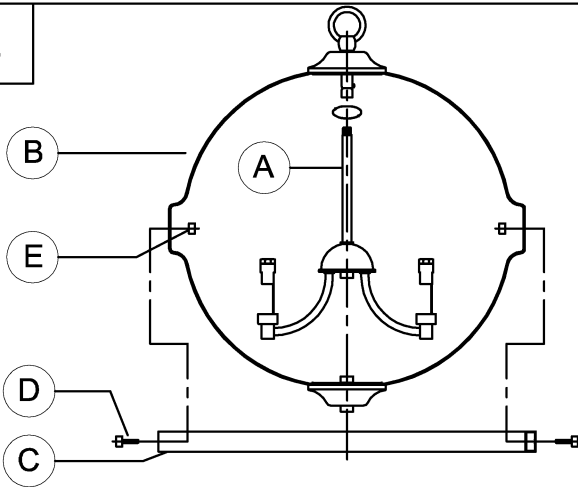

4. Attach fixture (A) onto the frame (B) secure tightly. As you do this, you will need to pull up the slack on the cord.  
Attach rectangle ring (C) onto frame (B) use screw (D) and finial (E) to secure tightly.

5

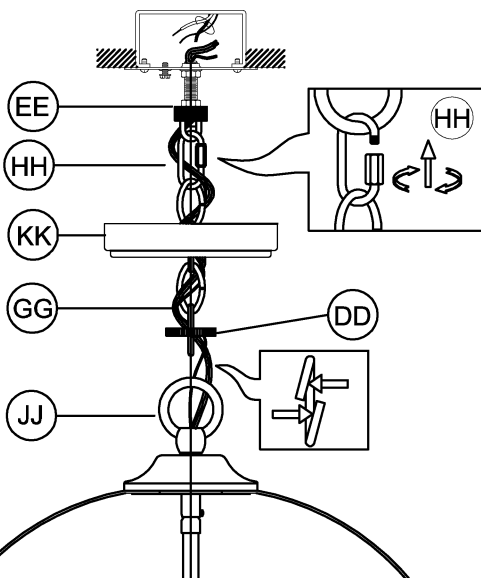





5. Pass the wires through the Chain loop (JJ). Weave wires through chain (GG). Pass wires and chain through screw collar (DD) and canopy (KK). Open one links of chain and attach to chain loop (JJ), Close the chain links. Attach the other end to the chain holder (EE) using quick-link (HH).

Pass the wires through the chain holder/ threaded nipple/ mounting plate.

NOTE: During this step, you may choose to shorten the chain and electrical/ ground wires.

## Hardware Used

(DD)	Screw collar		X1
(GG)	Chain		X1
(HH)	Quick-link		X1
(JJ)	Chain loop		X1
(KK)	Canopy		X1

# ASSEMBLY INSTRUCTIONS

6

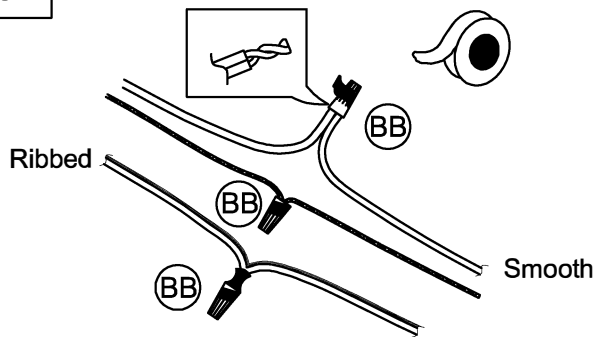

6. Strip 3/8" of insulation from the electrical wire ends. Using wire nuts (BB), connect RIBBED fixture wire to the WHITE supply wire from the outlet box; connect the SMOOTH fixture wire to the BLACK supply wire.

Connect the fixture ground wire and supply ground wire using a wire nut or by fastening to the ground screw on the mounting strap. Push all wire connections into the outlet box.

BB Wire nut

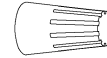

X3

7

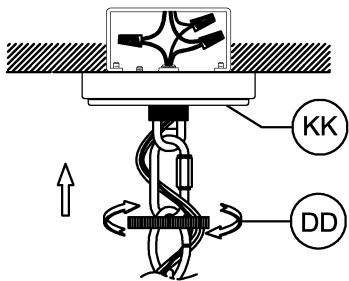

7. Tuck the wires into the outlet box and slip the canopy over the chain holder. Thread the screw collar (DD) onto the chain holder to secure the canopy tightly to the ceiling.

8

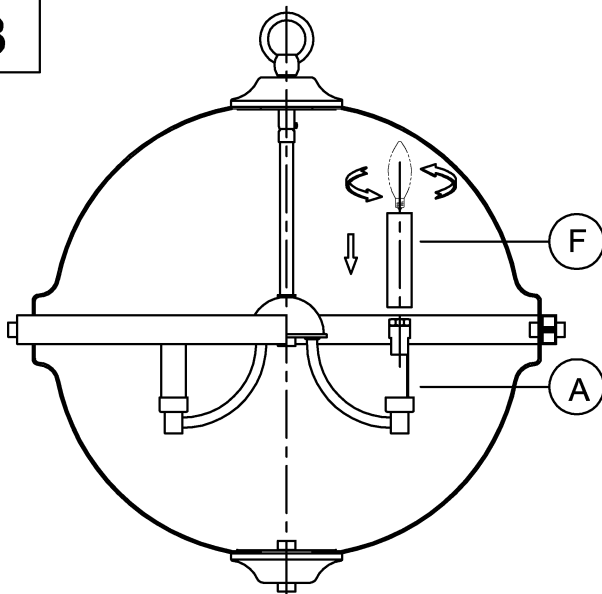

8. Place candle tube (F) onto fixture socket. Screw lamp (not included) into fixture socket. Use 60-watt MAX incandescent candelabra base, SBCFL or SBLED.



**Questions?**

Call our Customer Care Team at 1-855-303-4229

urban ambiance

[www.urbanambiance.com](http://www.urbanambiance.com)