

urban ambiance

Installation Instructions: **UHP3904**

PART	DESCRIPTION	QUANTITY		
		UHP3900/3	UHP3901/4	UHP3902/5
A	Fixture	1	1	1
B	Glass Shade	2	3	4
C	Socket Ring	2	3	4

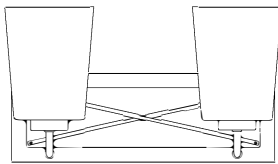

UHP3900/UHP3903

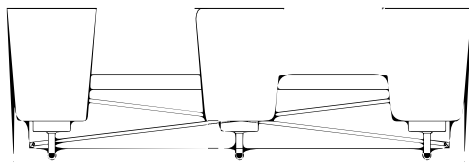

UHP3901/UHP3904

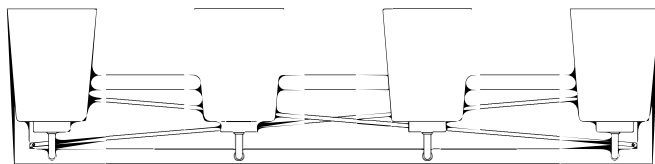

UHP3902/UHP3905

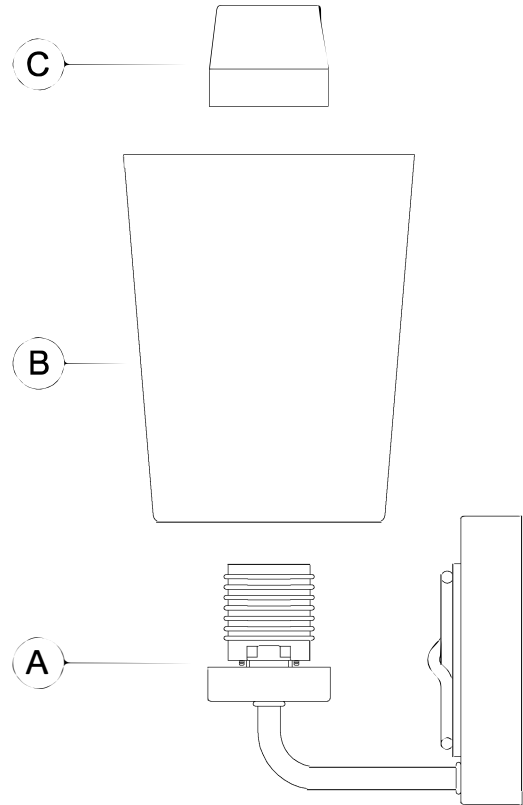

HARDWARE CONTENTS (not actual size)

AA	BB	CC	DD	EE
Screw (#8-32) Qty:2	Wire Nut Qty:3	Mounting Plate Qty:1	Anchor Screw Qty:4	Wall Anchor Qty:4



Questions?

Call our Customer Care Team at 1-855-303-4229

urban ambiance

www.urbanambiance.com



Safety Information

Please read and understand this entire manual before attempting to assemble, operate or install the product.

CAUTION: Read instructions carefully and turn electricity off at main circuit breaker panel before beginning installation.

CAUTION: Risk of fire. Min. 90°C supply conductors. Consult a qualified electrician to ensure correct branch circuit conductor.

WARNING: If any Special Control Devices are used with this fixture, follow instructions carefully to assure full compliance with N.E.C. requirements. If there are any questions, contact a qualified electrical contractor.

CAUTION: All glass is fragile. Use care when handling glass shades and bulbs.

Preparation

1. Before beginning installation, make sure all parts are included using the contents diagrams from page 1. If any part is missing or damaged, do not attempt to assemble, install or operate the product.
2. Estimated assembly time: 30 minutes.
3. Tools required for assembly (not included): Phillips screwdriver, pliers, wire stripper, safety glasses, electrical tape, ladder.

Care and Maintenance

Shut off main power supply before cleaning product or changing light bulbs. To clean, wipe with damp cloth. Do not use abrasive cleaners or cleaners that contain alcohol.

Assembly Instructions

1. Line up mounting holes on the Mounting Plate (CC) with screw holes on the outlet box.
Using the Mounting Plate (CC) as a template, locate the mounting slots on the outer edges of the Mounting Plate (CC).
Drill pilot holes for the Wall Anchors (EE). Remove mounting plate from the outlet box.

Press the Wall Anchors (EE) into the pilot holes. Install the Mounting Plate (CC) to the outlet box using the mounting screws (not provided).

Once Mounting Plate (CC) is installed, drive the provided Anchor screws (DD) into the installed Wall Anchors (EE).

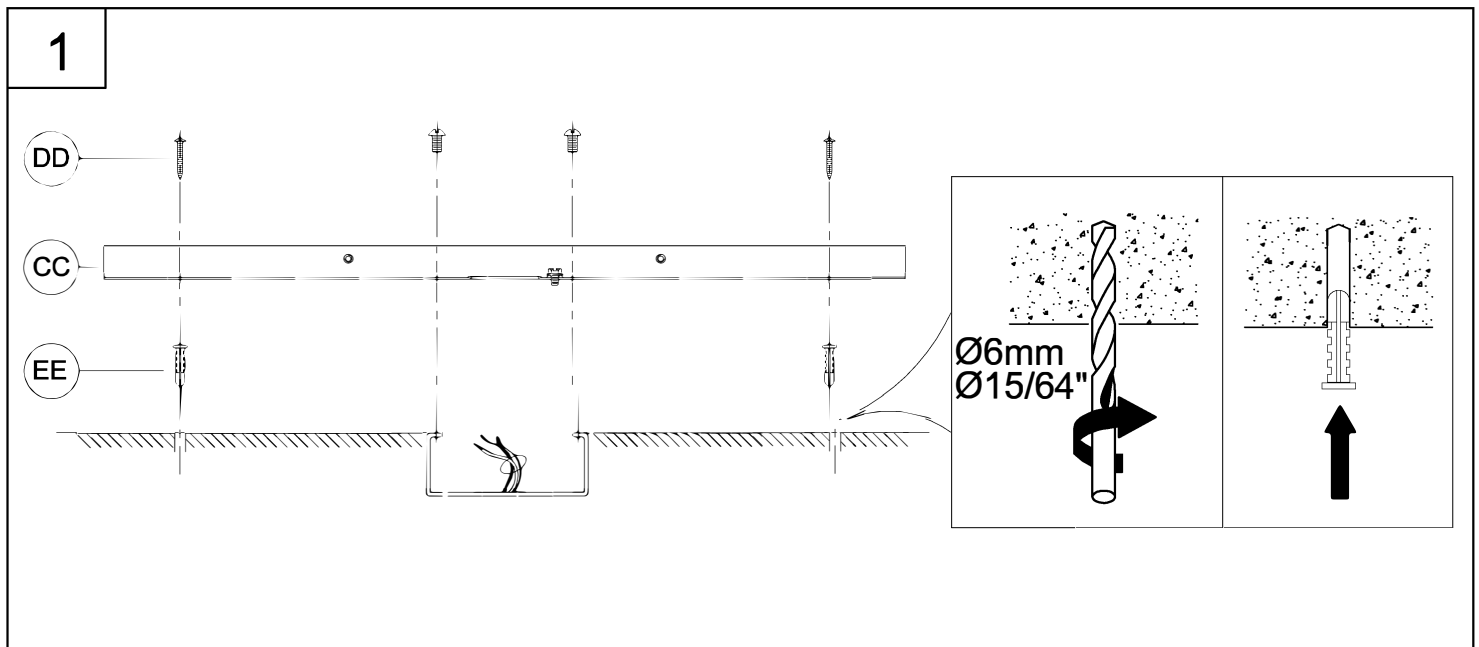

Assembly Instructions

2. Strip 3/8" of insulation from the electrical wire ends. Using wire nuts (BB), connect the WHITE fixture wire to the WHITE supply wire from the outlet box; connect the BLACK fixture wire to the BLACK supply wire from the outlet box.

Connect the fixture ground wire and supply ground wire using a wire nut or by fastening to the ground screw on the round mounting plate. Push all of the wire connections carefully into the outlet box.

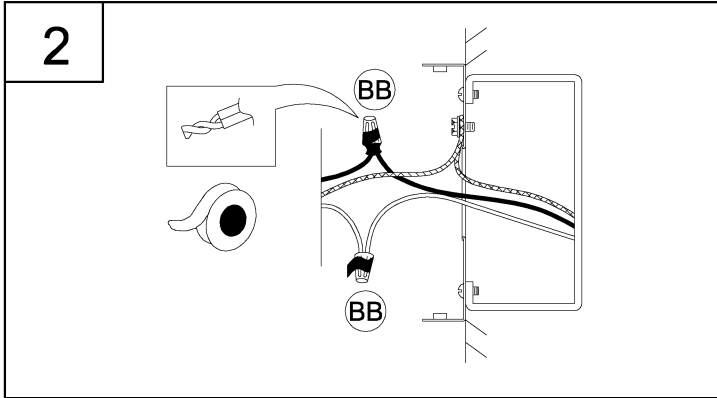

3. Attach the fixture (A) to the Mounting Plate (CC) and using the screws (AA), tighten the fixture against the mounting surface.

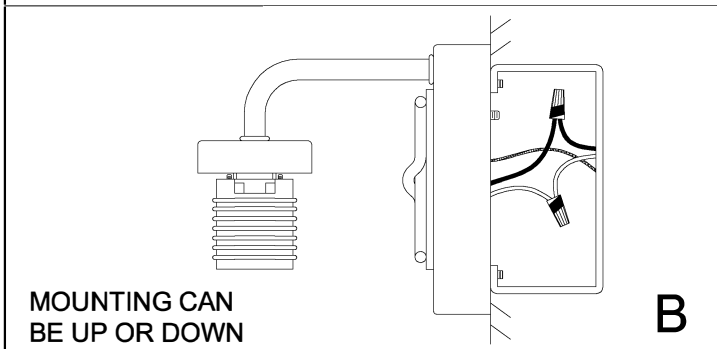
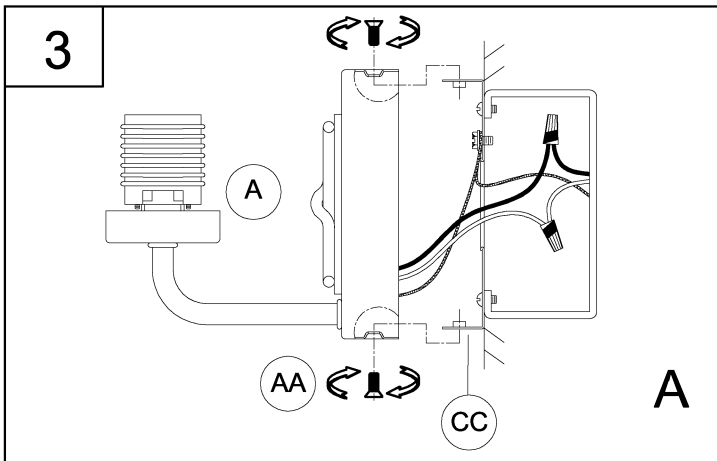

4. Place the glass shades (B) onto the fixture (A) and using the socket rings (C), secure them modestly tight.

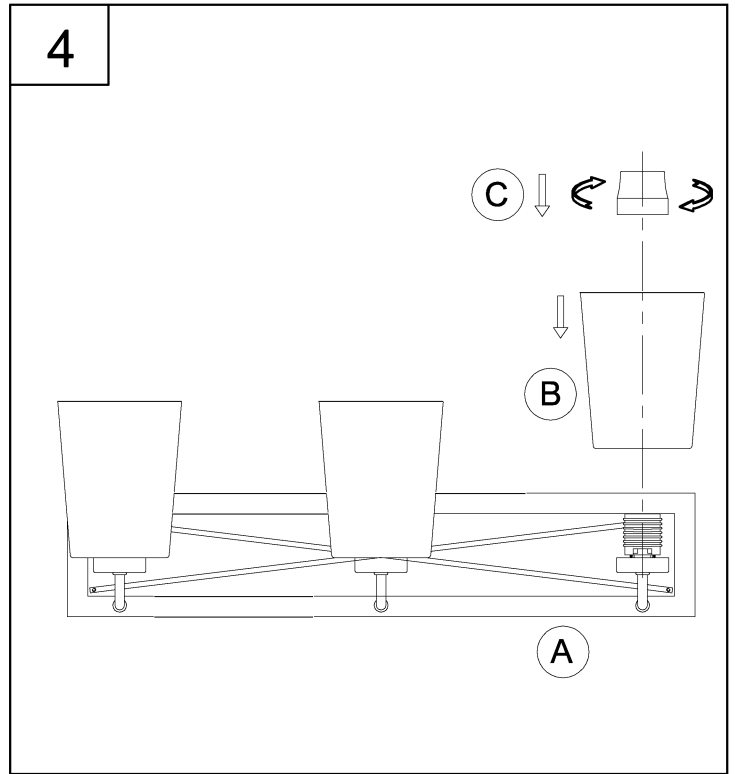

5. Thread the lamps (not included) into the fixture sockets. Use 60-watt MAX incandescent medium base lamp, SBCFL or SBLED.

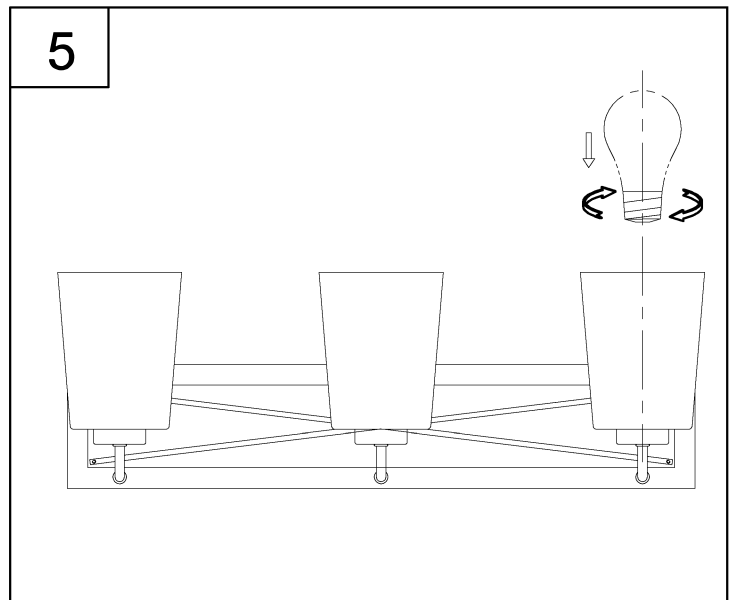

Questions?

Call our Customer Care Team at 1-855-303-4229

urban ambiance

www.urbanambiance.com