

**WARNING** - If any Special Control Devices are used with this Fixture, Follow the Instructions Carefully to assure full compliance with N.E.C. requirements. If there are any questions, contact a Qualified Electrical Contractor.

**WARNING** - This product contains chemicals known to the State of California to cause cancer, birth defects and /or other reproductive harm. Thoroughly wash hands after installing, handling, cleaning, or otherwise touching this product.

**CAUTION** - All glass is fragile, use care when handling Glass component(s) and or Lamp(s).

**ASSEMBLY STEPS:**  
**PASOS PARA ENSAMBLAR:**  
**MODE D'ASSEMBLAGE:**

1. D,E → A
2. B,A → C
3. F → G
4. H,J → D
5. L,M → K
6. N → K

**B, C, G & N  
 (NOT FURNISHED)  
 (NO INCLUIDA)  
 (NON FOURNIE)**

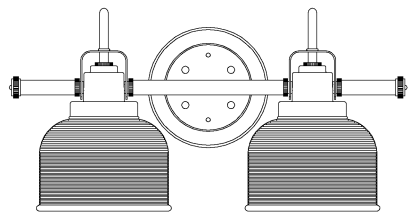
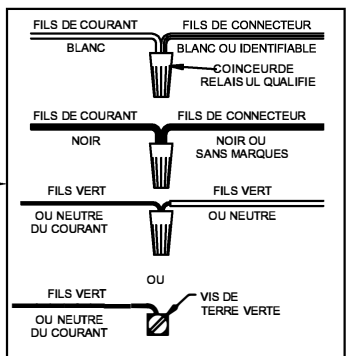
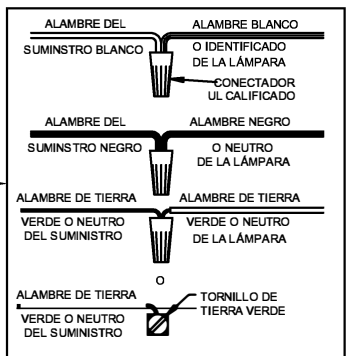
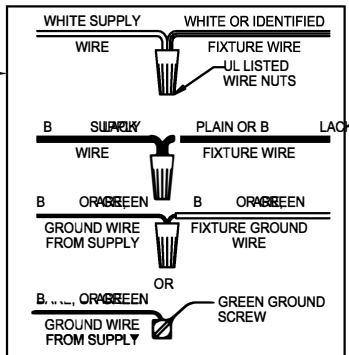
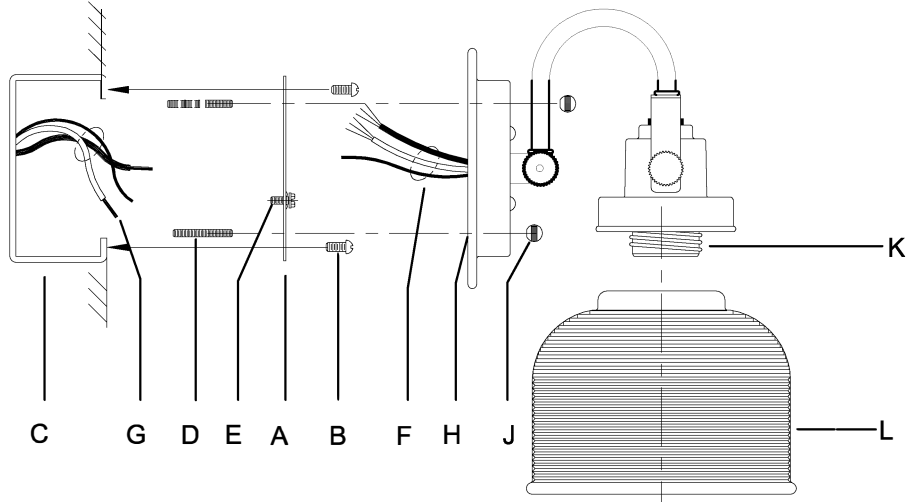
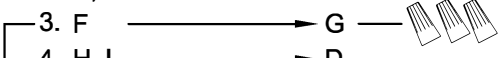

UHP2040, UHP2041, UHP2042

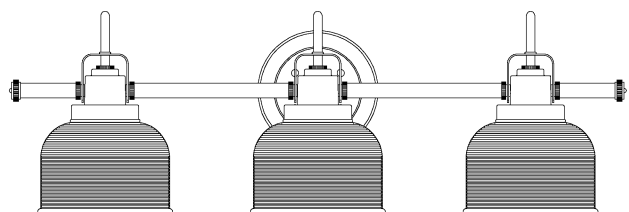

UHP2043, UHP2044, UHP2045

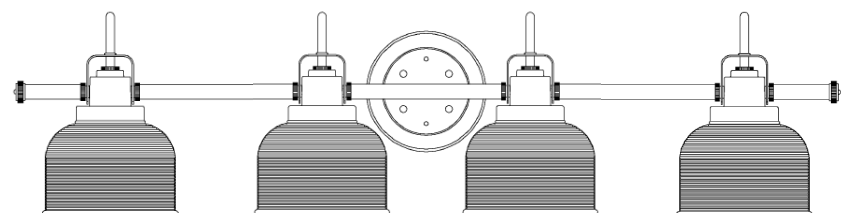

UHP2046, UHP2047, UHP2048

