

urban ambiance

Installation Instructions: **UHP1390**

PART	DESCRIPTION	QUANTITY		
		UHP1390	UHP1391	UHP1392
A	Fixture	1	1	1
B	Glass Shade	1	1	1
C	Socket cover	1	1	1
D	Socket Ring	1	1	1

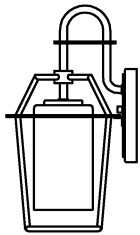
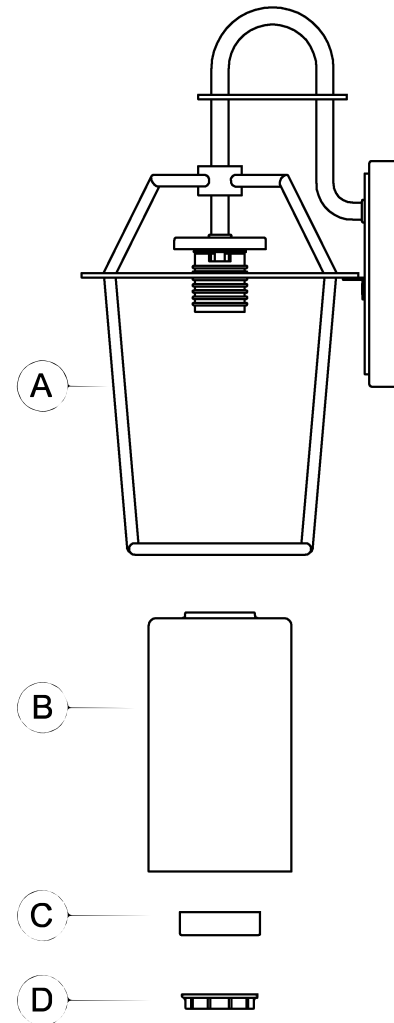

UHP1390

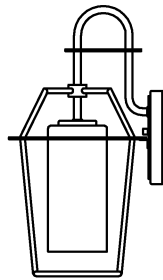



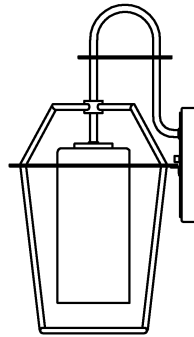

UHP1391

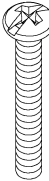
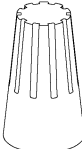
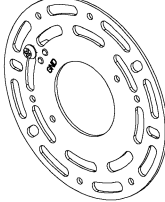

UHP1392

HARDWARE CONTENTS (not actual size)

<p>AA</p>  <p>Screw (#8-32) Qty:2</p>	<p>BB</p>  <p>Wire Nut Qty:3</p>	<p>CC</p>  <p>Round Mounting Plate Qty:1</p>	<p>DD</p>  <p>Hex Nut (#8-32) Qty:2</p>	<p>EE</p>  <p>Black rubber washer Qty:2</p>	<p>FF</p>  <p>Cylinder Nut (#8-32) Qty:2</p>
--	---	---	--	--	---



Questions?

Call our Customer Care Team at 1-855-303-4229

urban ambiance

www.urbanambiance.com



Safety Information

Please read and understand this entire manual before attempting to assemble, operate or install the product.

CAUTION: Read instructions carefully and turn electricity off at main circuit breaker panel before beginning installation.

CAUTION: Risk of fire. Min. 90°C supply conductors. Consult a qualified electrician to ensure correct branch circuit conductor.

WARNING: If any Special Control Devices are used with this fixture, follow instructions carefully to assure full compliance with N.E.C. requirements. If there are any questions, contact a qualified electrical contractor.

CAUTION: All glass is fragile. Use care when handling glass shades and bulbs.

WARNING - To comply with the National Electrical Code and Underwriters Laboratories requirements, when installed outdoors, or in wet locations, the edge of the wall plate coming in contact with the mounting surface, must be sealed with a latex waterproof caulking to prevent water from entering the outlet box.

Preparation

1. Before beginning installation, make sure all parts are included using the contents diagrams from page 1. If any part is missing or damaged, do not attempt to assemble, install or operate the product.
2. Estimated assembly time: 30 minutes.
3. Tools required for assembly (not included): Phillips screwdriver, pliers, wire stripper, safety glasses, electrical tape, ladder.

Care and Maintenance

Shut off main power supply before cleaning product or changing light bulbs. To clean, wipe with damp cloth. Do not use abrasive cleaners or cleaners that contain alcohol.

Assembly Instructions

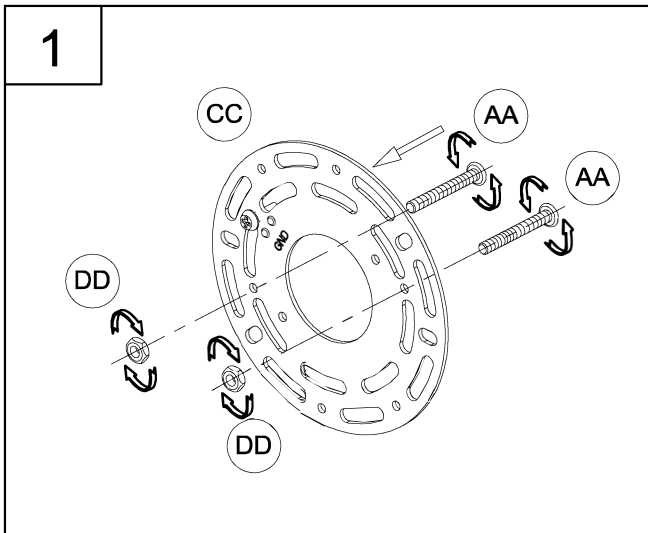

1. Loosely thread the screws (AA) and the hex nuts (DD) onto the round mounting plate (CC). You now need to adjust the screw length according to the fixture canopy depth.

2. Attach this assembly to the outlet box using the mounting screws supplied with the outlet box (not provided). Tighten securely.

Lift up the fixture to the mounting surface and pass the screws (AA) through the two mounting holes in the fixture canopy. While holding the fixture with one hand, thread the screws (AA) in or out of the round mounting plate (CC) until 3/16" of threads are showing. That should be enough to mount the fixture as instructed in step 4.

Next, take the fixture down and go back and tighten the hex nuts (DD) up against the round mounting plate (CC). You now should have the correct length of threads for mounting the fixture.

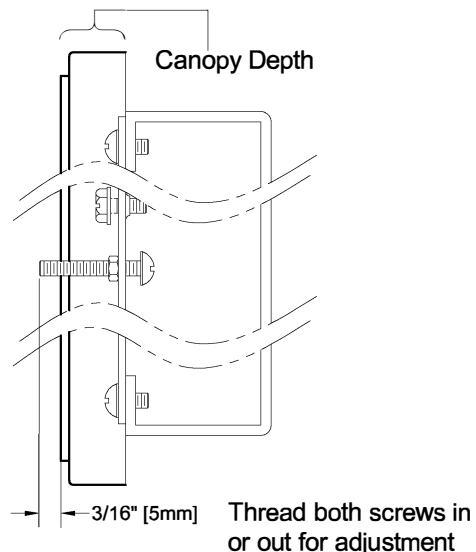
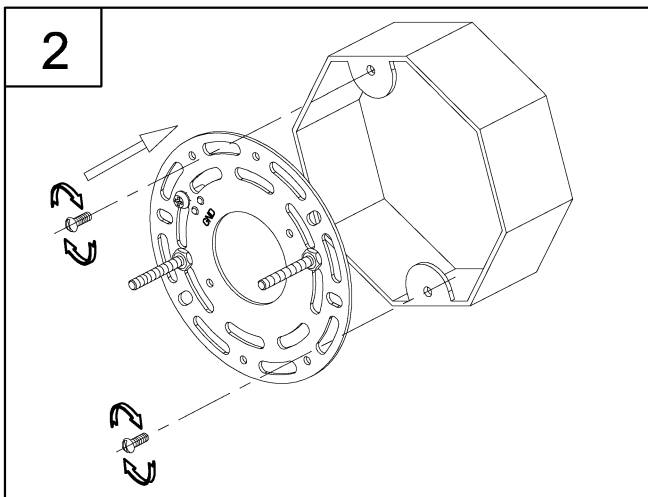

Assembly Instructions

3. Strip 3/8" of insulation from the electrical wire ends. Using wire nuts (BB), connect the WHITE fixture wire to the WHITE supply wire from the outlet box; connect the BLACK fixture wire to the BLACK supply wire from the outlet box..

Connect the fixture ground wire and supply ground wire using a wire nut or by fastening to the ground screw on the round mounting plate. Push all of the wire connections carefully into the outlet box.

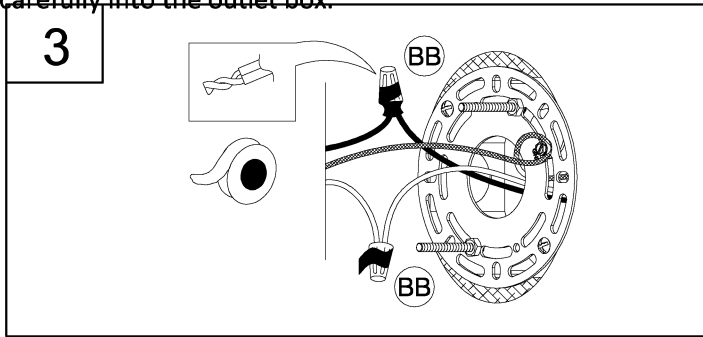

4. Slide the mounting holes in the fixture (A) over the screws (AA) and using the black rubber washer (EE) and cylinder nuts (FF), tighten the fixture against the mounting surface.

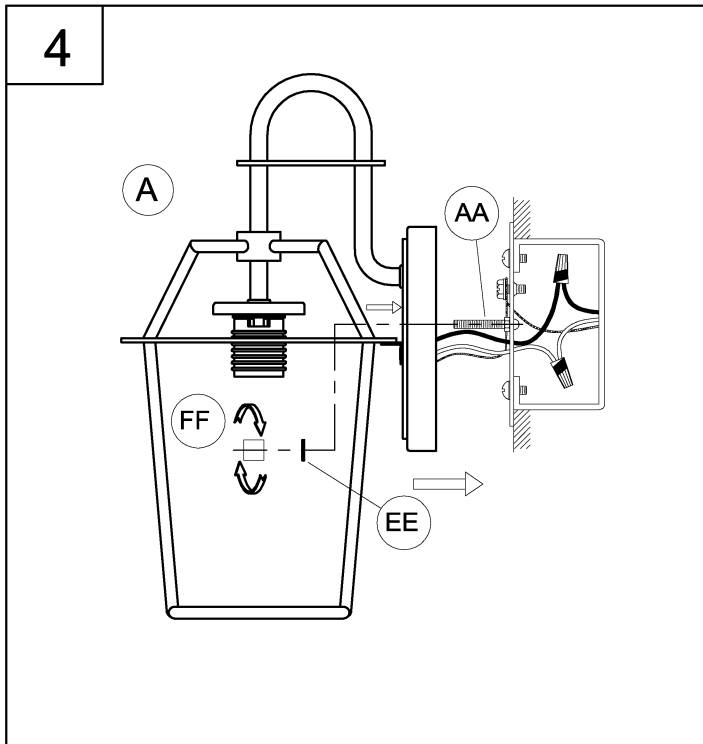

5. Attach the glass shade (B) and the socket cover (C) to the fixture (A) using the socket ring (D) to secure tightly. Thread the lamp (not included) into fixture socket. Use 60 or 100-watt MAX (see page 1) incandescent medium base lamp, SBCFL or SBLED.

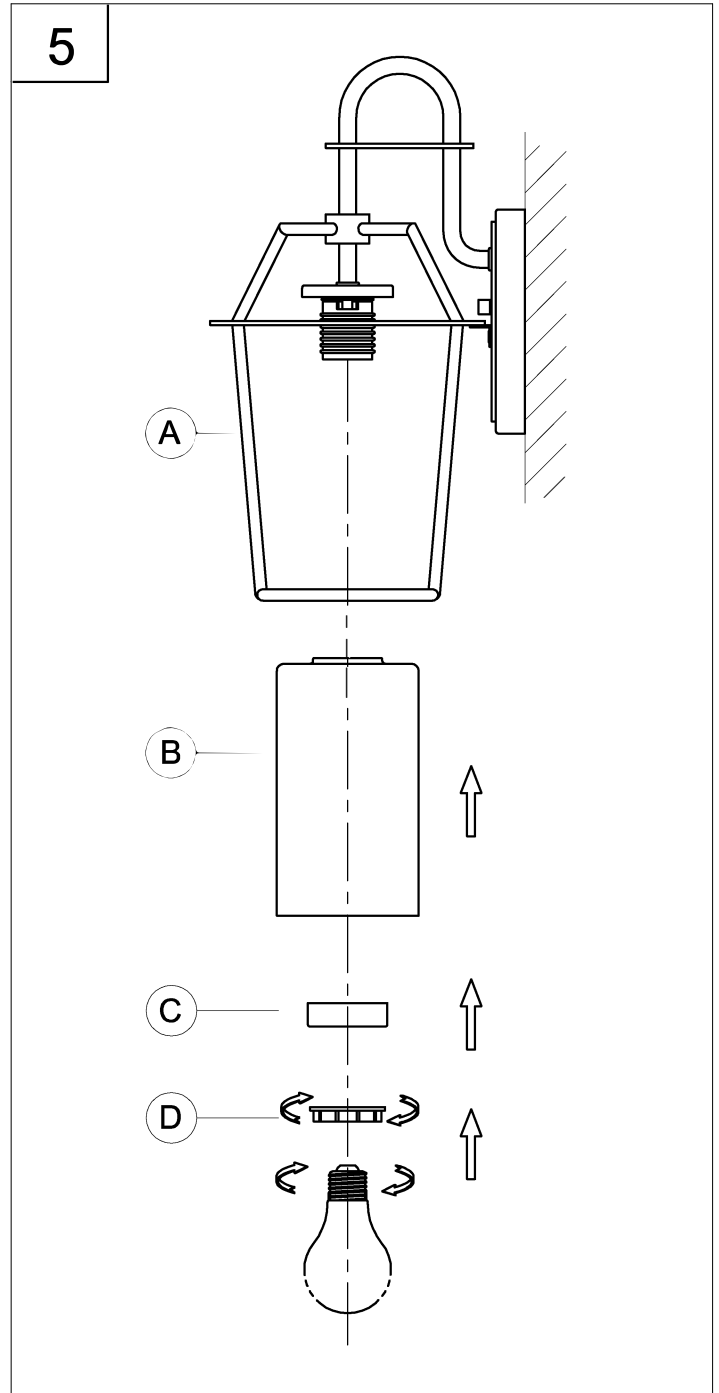

Questions?

Call our Customer Care Team at 1-855-303-4229

urban ambiance

www.urbanambiance.com