

urban ambiance

Installation Instructions: **UHP1374**

Part	Description	Quantity
A	Fixture	1
B	Roof	1
C	Rubber washer	2
D	Knurled nut	2

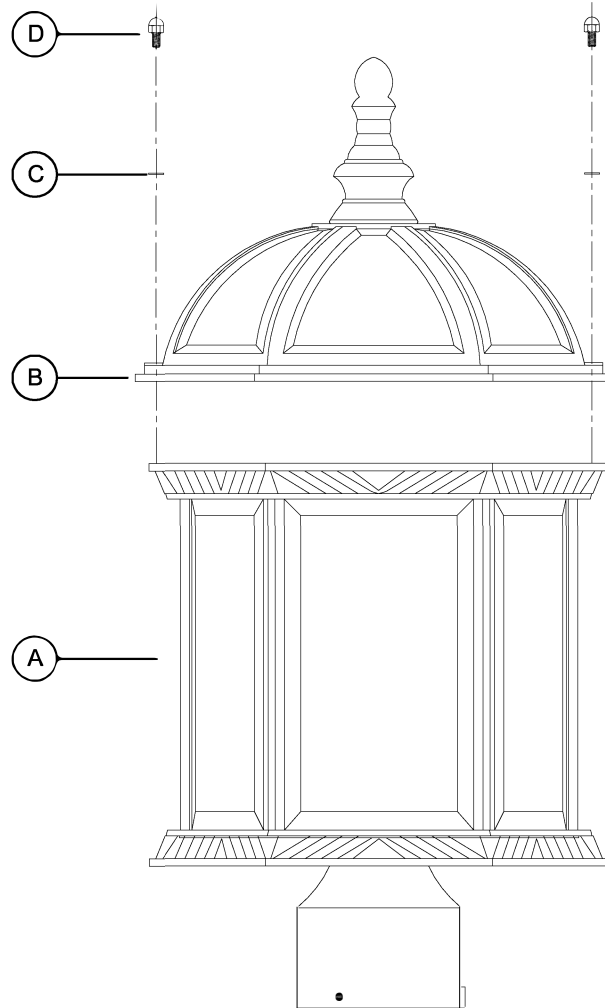

Hardware Contents (not actual size)

(AA)

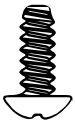

Mounting screw
(#10-16)
Qty:3

(BB)

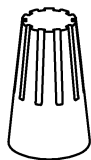

Wire nut
Qty:3



Questions?

Call our Customer Care Team at 1-855-303-4229

urban ambiance

www.urbanambiance.com



Safety Information

Please read and understand this entire manual before attempting to assemble, operate or install the product.

CAUTION: Read instructions carefully and turn electricity off at main circuit breaker panel before beginning installation.

CAUTION: Risk of fire. Min. 90°C supply conductors. Consult a qualified electrician to ensure correct branch circuit conductor.

WARNING: If any Special Control Devices are used with this fixture, follow instructions carefully to assure full compliance with N.E.C. requirements. If there are any questions, contact a qualified electrical contractor.

CAUTION: All glass is fragile. Use care when handling glass shades and bulbs.

Preparation

1. Before beginning installation, make sure all parts are included using the contents diagrams from page 1. If any part is missing or damage, do not attempt to assemble, install or operate the product.
2. Estimated assembly time: 30 minutes.
3. Tools required for assembly (not included): Phillips screwdriver, pliers, wire stripper, safety glasses, electrical tape, ladder, drill.

Care and Maintenance

Shut off main power supply before cleaning product or changing light bulbs. To clean, wipe with damp cloth. Do not use abrasive cleaners or cleaners that contain alcohol.

Assembly Instructions

1. Place the fixture (A) on the post (not included) and use a pencil to mark the locations of the 3 mounting holes. Remove the fixture from the post and use a drill with a 0.144 (4mm) bit to create mounting holes in the post.

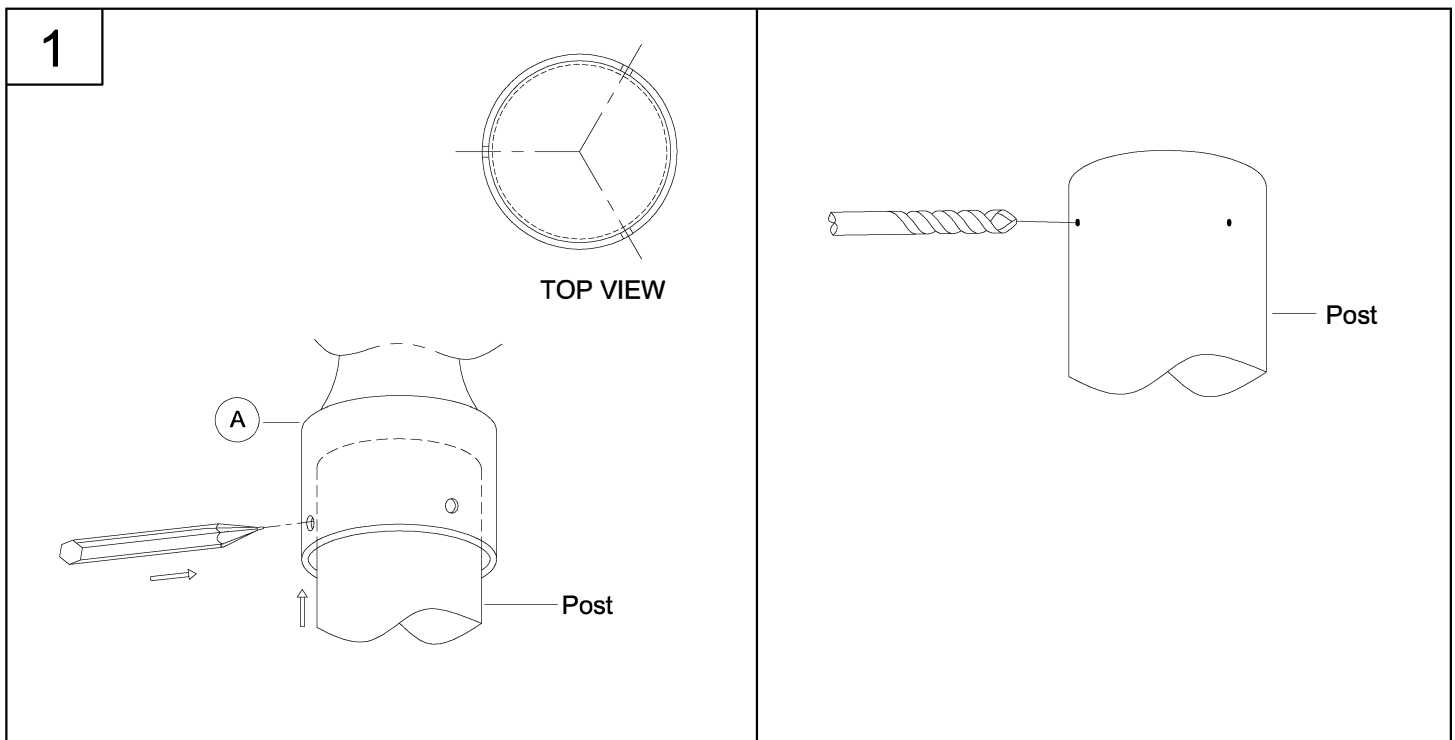

Assembly Instructions

2. Strip 3/8" of insulation from the electrical wire ends. Using wire nuts (BB), connect WHITE fixture wire to the WHITE supply wire from the pole connection; connect the BLACK fixture wire to the BLACK supply wire from the pole connection. Connect the fixture ground wire and supply ground wire using a wire nut. Push all wire connections into the post.

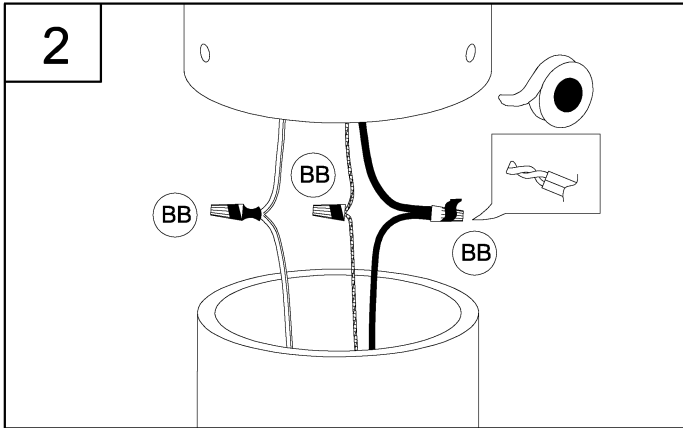

3. Insert the fixture (A) onto the post and use the mounting screws (AA) to secure the fixture tightly to the post using the holes drilled in step 1.

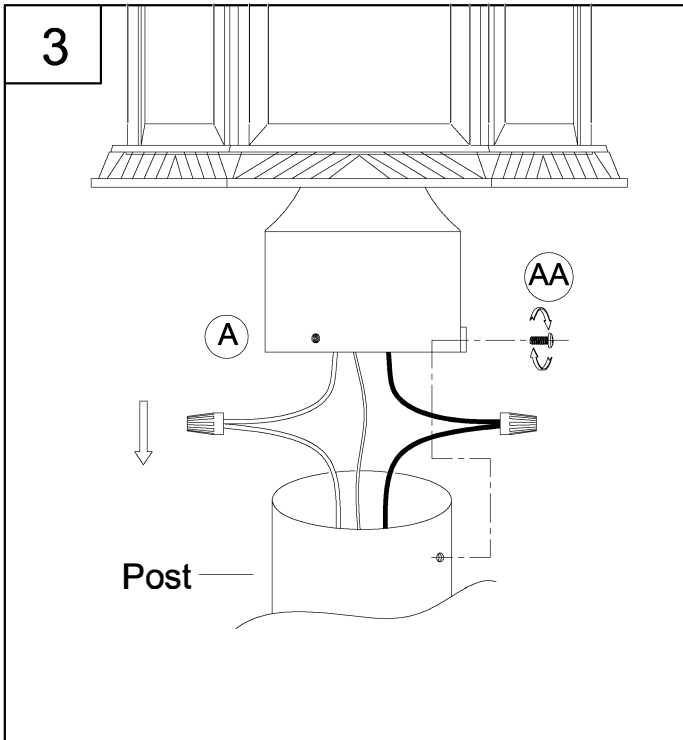

4. Thread lamp (not included) into the fixture socket. Use a 60-watt MAX incandescent medium base lamp, SBCFL or SBLED.

Attach the roof (B) onto the Fixture (A) and using the rubber washer (C) and knurled nut (D). Tighten securely.

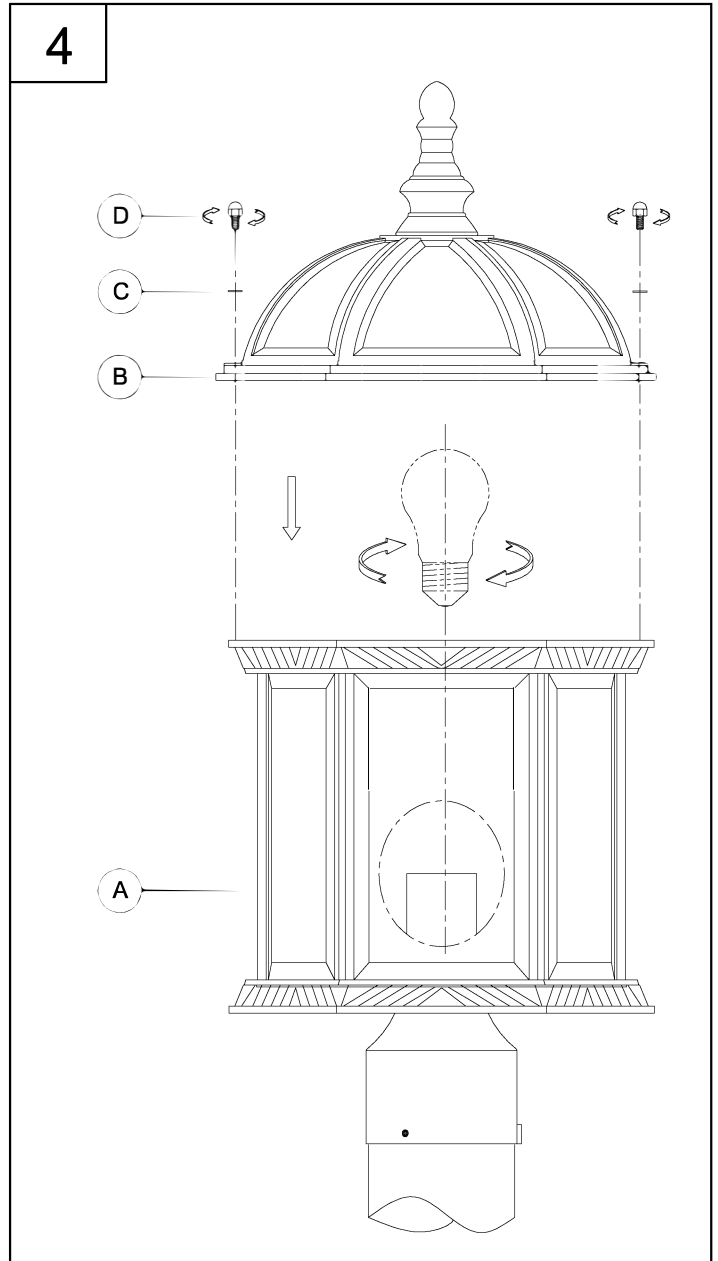

Questions?

Call our Customer Care Team at 1-855-303-4229

urban ambiance

www.urbanambiance.com