



PS65

SAN MARINO GLASS BOWL SPA

MANUAL

**PIBBS INDUSTRIES
133-15 32ND AVE
FLUSHING NY 11354
TEL:718-445-8046**

FOOT SPA OWNER'S MANUAL

Tables of Contents

| | |
|--|---------------|
| Inspection & Precautions | P2 |
| Electrical and Plumbing Requirements | P3 |
| • Electrical requirement | |
| • Water supply / water pressure / water temperature / water drain line | |
| Installation | P4 –P7 |
| • Floor level and plumbing connection | |
| • Connect hot and cold water supply / drain line | |
| • Electrical connection | |
| • Install and operate foot rest | |
| • Testing the pedicure spa | |
| • How to take out motor | |
| • Attaching chair with base | |
| Operation Instruction | P 8 |
| • Add water / turn off water | |
| • Remove water from the pedicure spa basin | |
| Limit Warranty | P 9 |
| Pedicure Spa Cleaning Guide | P 9 |

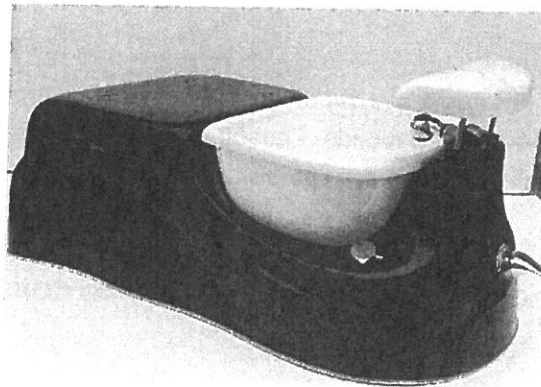
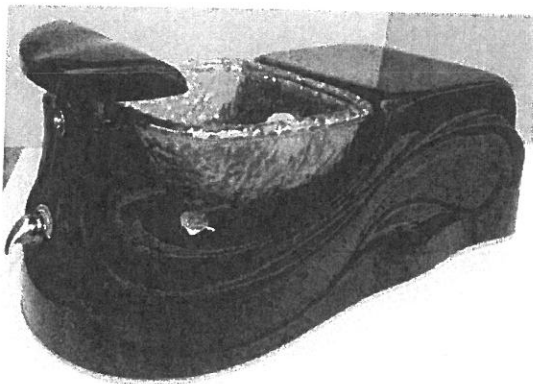

Electrical and Plumbing Requirements

The pedicure spa base must be conveniently located near adequate utilities as follow:

- **Electrical Requirement**

The pipe-free jet motor is DC24V brushless can be operated from AC100V-240V, 50/ 60 Hz. GFCI (Ground Fault Circuit Interrupter) MUST be used to supply power to the Foot Spa.

WARNING: You must call a qualified electrician to connect the pedicure spa. Failure to do so may result in serious injury or death due to electrical shock.

- **Water Supply :**

Water supply to the pedicure spa should consist of a system that will provide both adequate water pressure and water temperature. All plumbing connections must conform to local codes.

NOTE : For safety and keep motor life, the DC24V brushless motor will off power automatically if tank without enough water inside. The light of on (off) button flash if motor off power.

- **Water pressure / temperature :**

Normal water pressure of 30 -120 P.S.I. is required to correctly fill the tub to proper levels . The water temperature should never exceed 105° F (38° C). This temperature should not create a problem for any normal water heater in good working order.

- **Water Drain Line:**

Connect the foot spa drain system with enclosed drain pipe before you drain water from the tub. You can ask your local, qualified electrician and plumber to install a drain pump if necessary. (Drain pump is an optional parts could be installed in factory if requested , If your base installed with drain pump , please note that you have to open drain plug before you turn on drain pump , if not , the drain plug will be locked caused by powerful drain pump power.

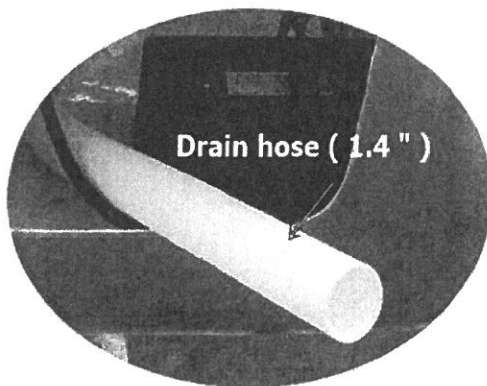

Installation

The installation must comply with local, state and national building, plumbing and electrical codes, where applicable. A licensed plumber should complete the installation. Electrical wiring, components and connections must be completed by a licensed electrician.

- **Floor Level:**

Select a level location where the floor structure beneath the spa is capable of supporting it.

IMPORTANT:

For safety, the base of the pedicure spa must be a minimum of 28" from the back wall. If this distance is less, the seat back will still recline; however, it will hit the back wall.

- **Plumbing connection**

All plumbing connections drain and fresh hot / cold water should be made by a qualified, licensed plumber in accordance with local plumbing and building codes. Drain pump is a optional part.

a. Connect Hot and Cold water supply:

Carefully connect 0.5" - ID supply tubes to a fresh water source. Shut-off valves should be utilized.

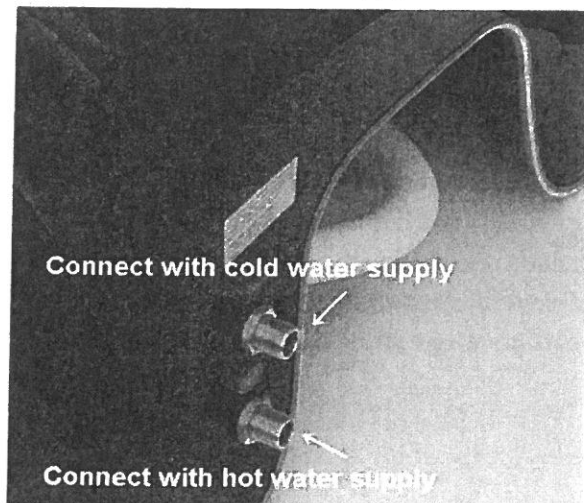

b. Connect drain line:

Using scheduled drain pipe and appropriate traps, connect drain to meet local plumbing codes.

- **Electrical Connection:**

All electrical connections MUST be made by a qualified, licensed electrician in accordance with Local and National Electrical and Building Codes. GFCI protected grounded circuit MUST be used to supply power to the pedicure spa directly.

- Install foot rest bracket (highness is adjustable)

Insert enclosed U metal bracket of foot rest into the two holes of black color adjuster. Pull foot rest directly to the ideal position you want . Push two foot rest adjusters at same time in order to lowering the highness of foot rest .

Noted. Do not put hands on the bottom of the foot rest when you low it.

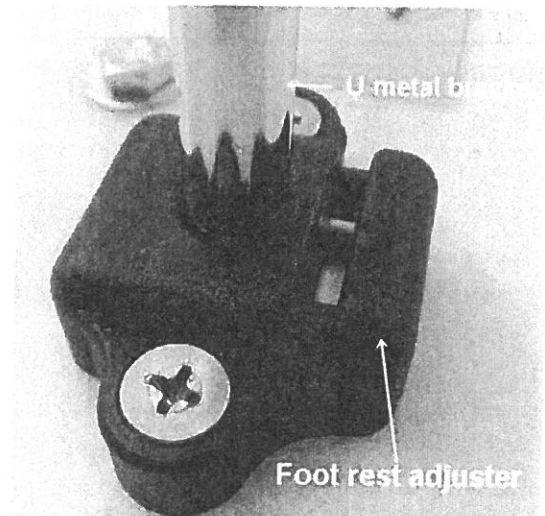
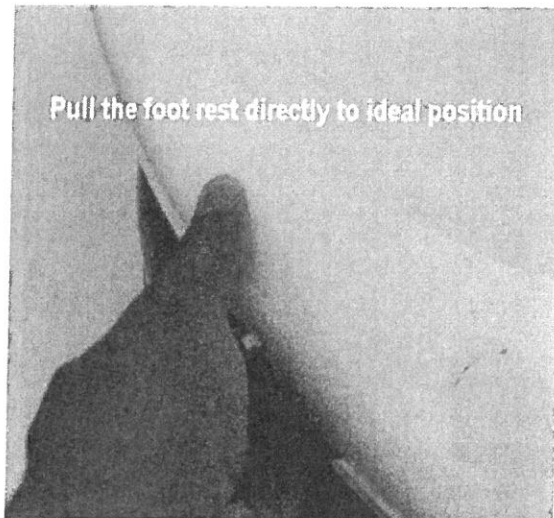
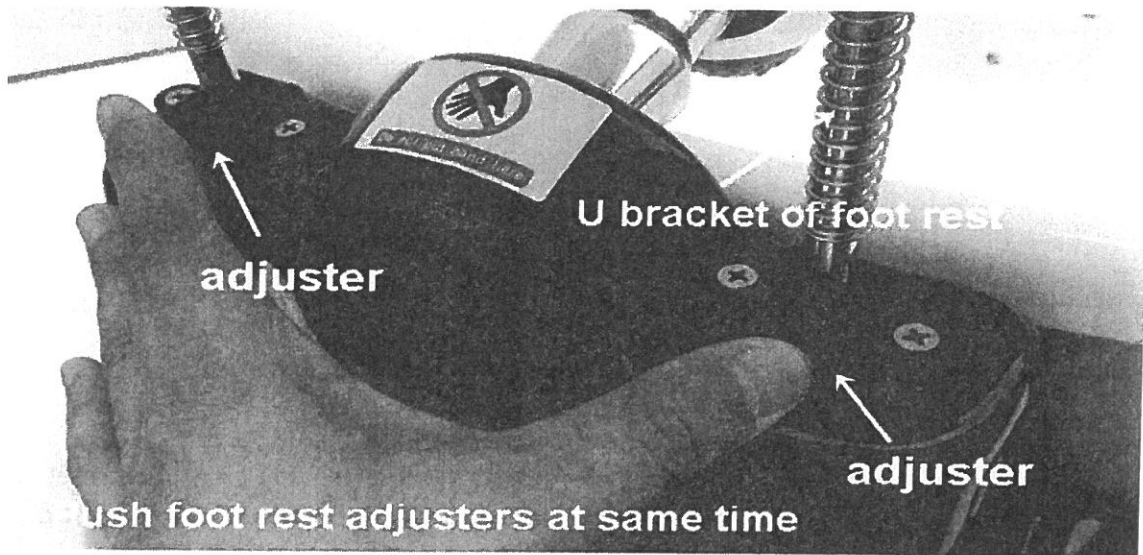

- **Testing the pedicure spa :**

After the plumbing and electrical connections have been made and the base unit has been secured to the floor, clean the bowl and fill with water **HIGH** than motor housing . After the bowl is filled with enough water, press the Jet (On/ Off) button on the front of the pedicure spa to turn the jet motor on, press the same button to turn the jet motor off .

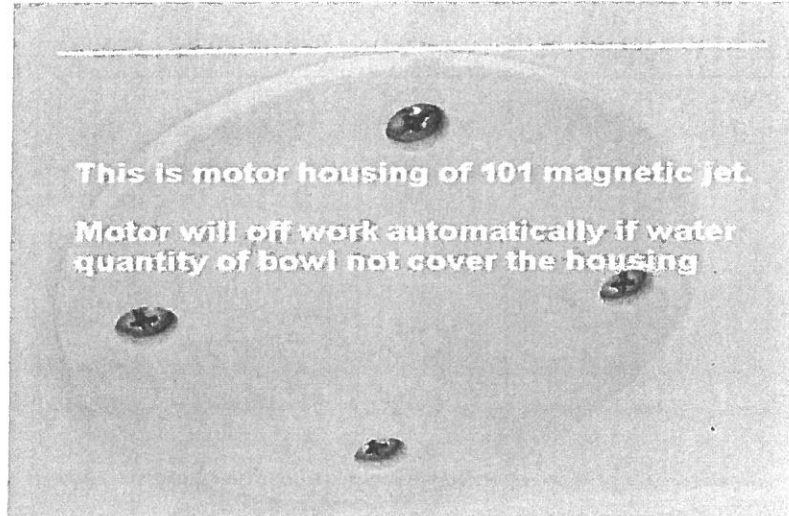

Noted : there is a triangle point on impeller housing and convex point on jet cover . Must level the two points when you close the jet cover . Must be in up position as shown when you put the 101 magnetic jet on motor housing for whirlpool working correctly (If the jet cover on motor housing was at up side down position, the water of bowl could spray out)

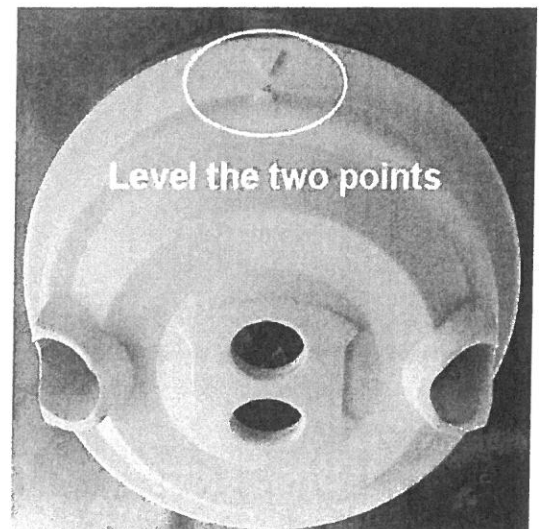
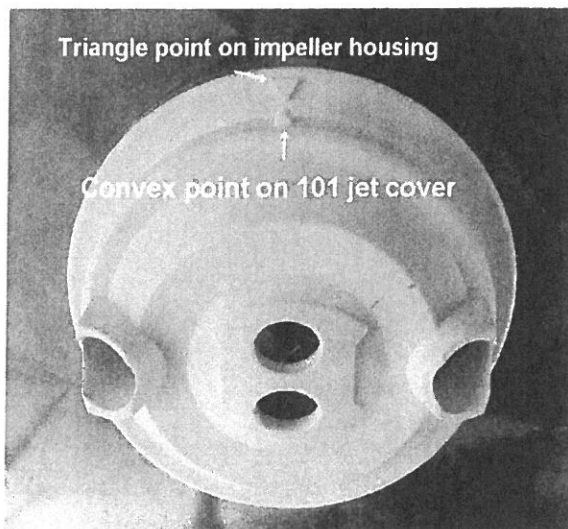

● How to take out motor

Our 101 magnetic jet with certificated UL/CE DC brushless motor. However , If any problem happen, you can replace it easily.

Step 1) – Take whole jet cover set from motor housing .



Step 2) – Loose four screws of motor housing from locker.

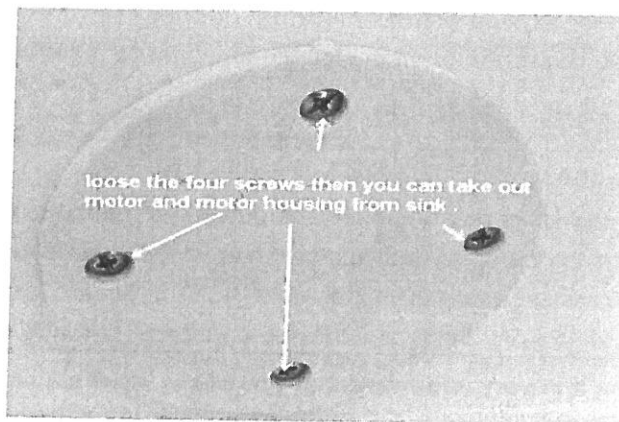

Step 3) Take out motor from motor housing by single hand as shown

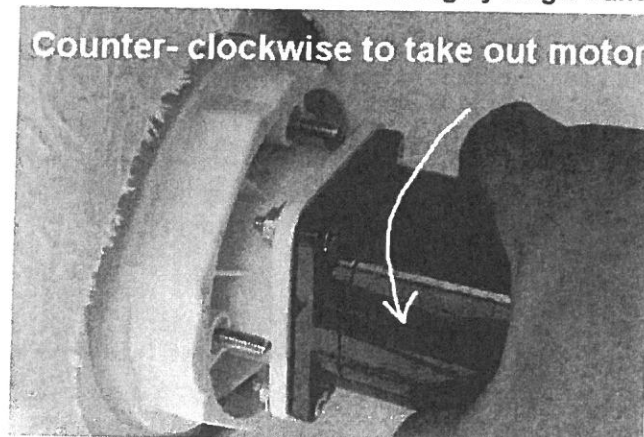

- **Attaching Chair with Base :**

Your Foot spa is shipped with base and chair at separate carton box. However, you must install the chair on base . **NOTED: MUST USE ENCLOSED SCREWS TO TIGHT CHAIR ON BASE .**

Operation Instruction

- **Add Water to the pedicure spa basin:**

- a. Turn the drain handle until drain plug close drain hole.
- b. Lift upward on the hot & cold control faucet to add water to the basin.
- c. Turn the handle direction for cold water or warm water as indicated by the red (hot) and blue (cold) markings upon the handle. Continue to add water until water over motor housing .

CAUTION: Always check water temperature before use; hot water can burn skin. Water temperature should not exceed 105° F (38° C) . The electronic power of pipe less jet will turn off automatically if the basin without enough water inside. The power of jet motor was built-in 30 minutes timer.

- **Turn off water:**

Turn the off water by pushing the handle downward. Start or stop the jet motor by pressing the On/Off light switch button.

- **Remove water from the spa basin:**

Make sure that the spa jet motor is turned off by pressing the on/off button. For use with a floor drain, simply open the drain by turning the drain knob in a clockwise direction until it stops. You should see the water level lowering as water exits the basin.

NOTE: If you are using a wall drain, it is very important that you close the drain cap for each use. Failure to do so will result in contamination of the system.

NOTE: DO NOT turn the spa "ON" unless adequate water is fully filled in the tub

NOTE : Do not drain the tank until the jet motor has completely stopped operating. Turn the drain assembly to drain the water from the tub and plumbing system. **IMPORTANT:** The entire system is automatically self-draining and should be drained after each use so that no stagnant water remains in the jet system.

Limit Warranty

The foot spa was made under high standards of workmanship and with high quality materials. According our expressly warranty the foot spa as below:

TO the original owner of the foot spa . We may repair or exchange at its option, any foot spa found to be defective in material or workmanship upon inspection by our authorized distributor. This warranty covers the following components for the following time periods :

- Electric motor and control system : One year from date of purchase

The exchange of a foot spa is limited to supplying a replacement foot spa of a comparable style and size. Owner must pay all labor and delivery charge necessary to replace or repair the foot spa.

PLEASE NOTE: This warranty is null and void if the foot spa is removed from its place of initial installation, or is not installed in accordance with federal, state or local codes and ordinances.

Furthermore, this warranty does not apply if the foot spa has been subject to misapplication, improper installation or maintenance or other circumstances beyond our can control.

Should service be required for any reason of any defect during the warranty period, please contact the with your supplier.

Pedicure Spa Cleaning Guide

Thorough cleaning is key. Good care required both cleaning the basin after each customer and flushing the entire system periodically. How often the system needs flushed depends largely on your volume. Be careful not to use anything that could scratch or gouge the surface, as those places can become breeding grounds for bacteria. We recommends below for cleaning.

- Drain all water and remove all debris from the pedicure spa.
- Clean the surface and walls of the spa with soap or detergent and rinse with clean water.
- Wipe dry with clean towel.
- Remove the jet cover. All debris trapped behind the jet cover of each pedicure spa needs to be removed, and the cover inlet need to be washed with soap or detergent and water.
- Procedures for the end of each day, fill the pedicure spa with water and four teaspoons of 5% bleach solution (a dose of 50 parts per million ppm: 0.64 oz).

IMPORTANT : The spa are made from high quality material. When cleaning, do not use acid or alkaline based cleaning liquids. Refrain from scrubbing surface with rough or sharp instruments. Clean and maintain surface with mild detergent and soft sponge or cloth only. Thank you..

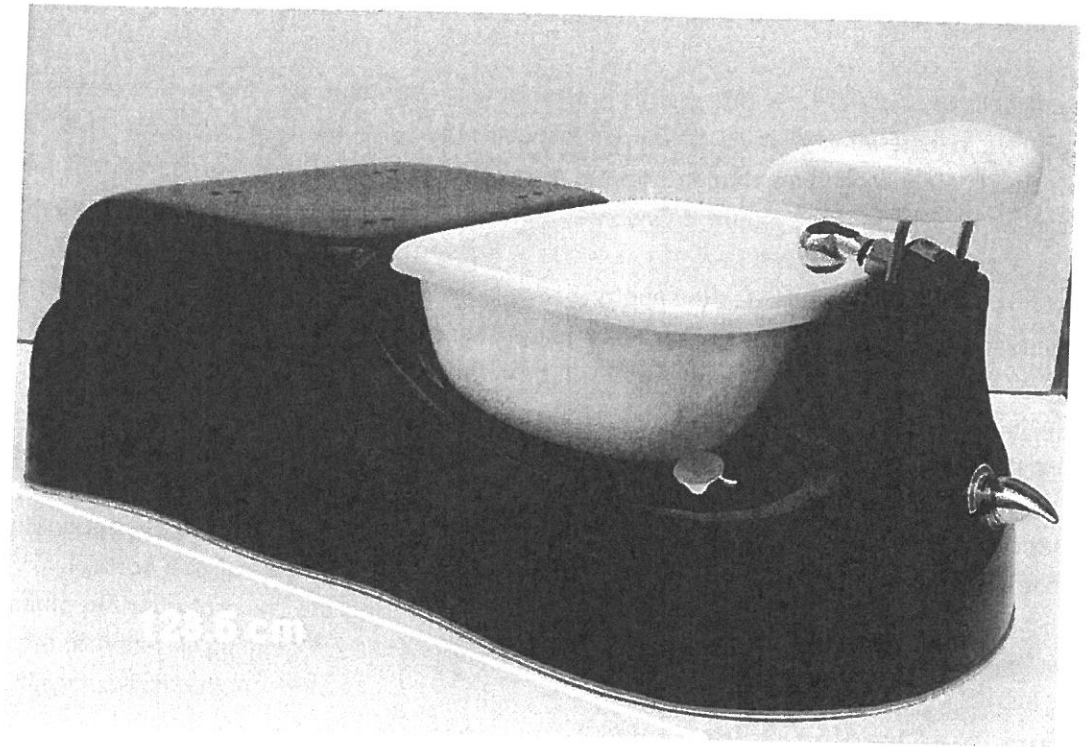

DATE OF INSTALLATION : _____

NAME OF SALON : _____

SERIAL NUMBER : _____

STAMP OR SIGN OF DEALER

PIBBS PS65-1

DIMENSIONS

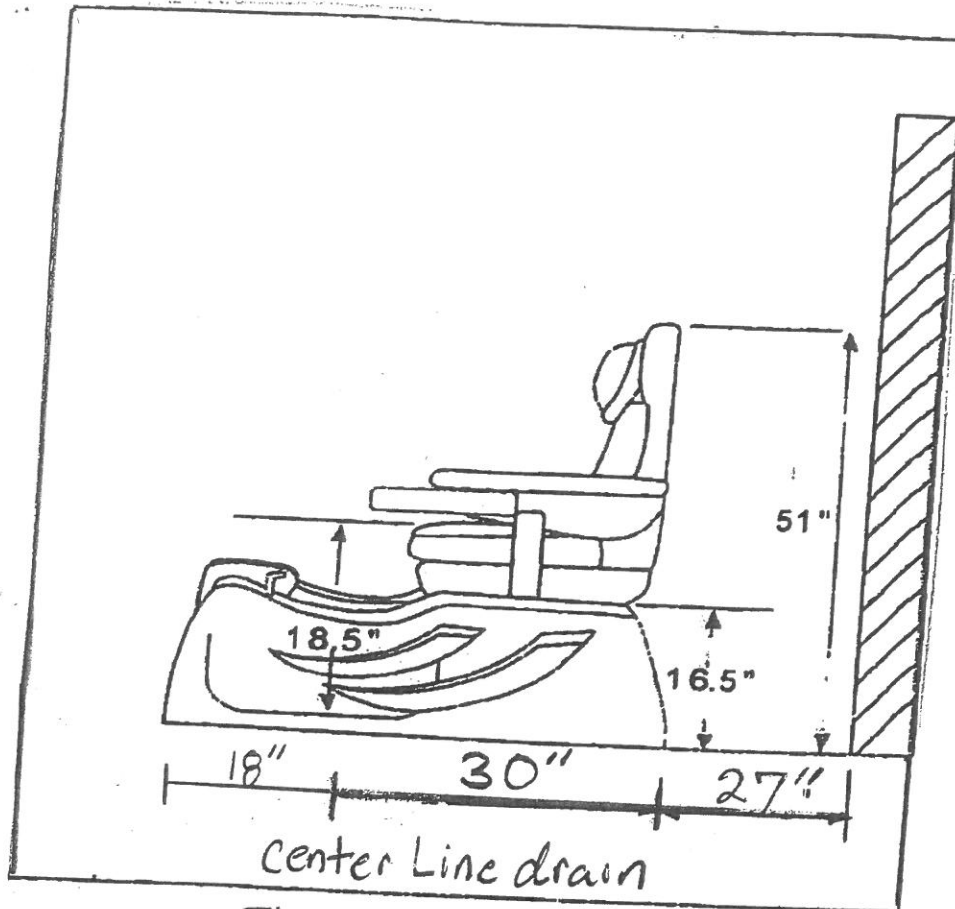

Floor drain to be behind
Center Line drain

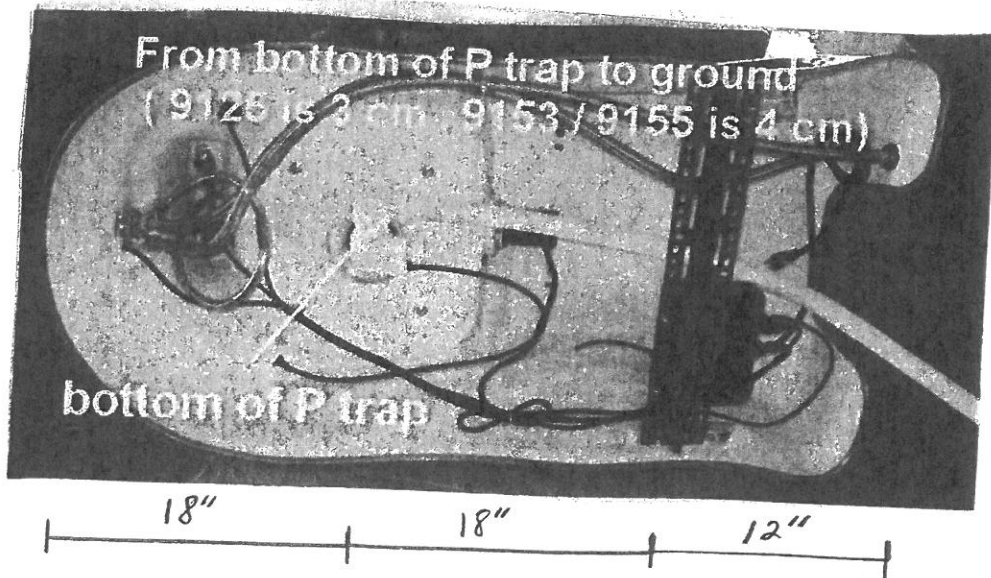

Inspection & Precautions

We sincerely thank you for purchasing our high quality of pedicure spa on the market . This innovative foot spa has been designed to service your clients dependably. Please take time to read through this entire manual before installation and use.

PLEASE READ AND FOLLOW INSTRUCTIONS CAREFULLY !

Upon the receipt of your spa base and chair , please inspect goods carefully for shipping damage immediately upon arrival. Contact your supplier if any damage is found.

If unseen loss or damage is found, you must notify the freight line immediately and request an inspection of the damage. **PLEASE DO NOT DISCARD ANY PART OF THE SHIPPING CARTON.** If you give the carrier a clear receipt for goods that have been damaged in transit, you do so at your own risk and expense.

Important Precautions -----

We require that you should contact your local, qualified electrician and plumber to install your whirlpool foot spa . It can not operate efficiently or safely unless it is provided with adequate electrical power, sufficient water pressure, proper water temperature and required drain facilities. Information on these important subjects are contained in this manual. We urge you to read it carefully to make sure these requirements are met.

Precautions -----

1. Excessive water temperature is dangerous and should be checked before use. Maximum water temperature should not exceed 105° F (38 ° C)
2. Always enter and exit the foot spa slowly and carefully.
3. Never bring and / or operate any electrical devices into the foot spa.
4. Do not stand in the whirlpool tank (sink) !
5. This foot spa has a weight capacity of 250lb (113 KGS).

Warning -----

Do not use if you are diabetic, have poor circulation , or if any area of your feet or leg are inflamed or have open wounds. Consult your physician before using if you have any kind of fungal infection, swelling , fracture , or persistent pain.

Massage should be pleasant and comfortable . **IF YOU EXPERIENCE PAIN OR DISCOMFORT, DISCONTINUE USE IMMEDIATELY AND CONSULT YOUR PHYSICIAN.**