

OWNER MANUAL

PLEASE SAVE THIS MANUAL
FOR FUTURE REFERENCE

FLORENCE

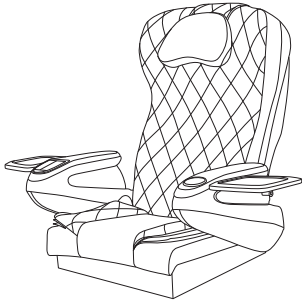

Chair 9660



Chair 9620-1



WATERDANCE[®]
SYSTEM

Gulfstream

WATERDANCE[®], FLORENCE[™], Gulfstream Inc.[®] are trademarks of Gulfstream Inc.

Patent #D709619, #8726430, #8680699, #D701318, #8662848, #8531048, #8366418, #D670938, #D670354, #D662340, #D660444, #D650084, #D646082, #D636090, #D632798, #D628704, #D615326, #D613099, #D612509, #D610697, #D600950, #D596883, #D596882, #D590188, #D589285, #D588844, #D583960, #D583576, #D583171, #D565739, #D556480, #7111334, #6991182

© 2019 All rights reserved. Design and Specifications are subject to change without notice.

Table of Contents

Owner Manual

| | |
|------------------------------|-------|
| Safety and Precautions | 1-2 |
| Identifying Parts..... | 3-4 |
| Foot-Spa Clearance | 5 |
| INSTALLATIONS | |
| Attaching Seat | 6 |
| Waterdance Operation | 7-8 |
| Plumbing Connections | 9-10 |
| | |
| Operations and Use | 11-12 |
| Cleaning & Maintenance | 13 |
| | |
| Warranty & Service | 14 |

Thank you for purchasing the Florence Spa from Gulfstream Inc. Please carefully read the instructions before installing the spa. Carefully follow the instructions and your spa will give you years of beauty and service.

This product is to be connected to a branch circuit outlet protected by a Class A GROUND FAULT CIRCUIT INTERRUPTER (GFCI), and the GFCI shall be tested regularly for continued protection and correct operation. If a Class A GFCI protected outlet is not available, **DO NOT USE THIS PRODUCT!** Please contact a licensed electrician for installation of a Class A GFCI according to local electric codes, or equivalent.

**Warning**

**THIS PRODUCT IS FOR INDOOR USE ONLY
DISCONNECT POWER SUPPLY CORD BEFORE SERVICING AND CLEANING**

The foot-spa must be installed by a licensed plumber and electrician in accordance with local codes. Plumbing and Electrical Installation instructions must be adhered to in order for the warranty to be in effect and to ensure the utmost in safety. The chair and spa have a maximum seating capacity of **350 pounds**.

The foot-spa is not intended to be stood in or used as a step. The portable foot-spa model is movable, standing in tub or using as a step may cause severe damage to the unit as well as possible serious injury to the person.

**Warning**

If a crack occurs in the glass bowl, **DO NOT** manually handle the bowl unless the proper attire is worn. Under no circumstances may the bowl be used by your customers as you could be held accountable for any injury that may occur. Gulfstream is not liable for any injury that may occur.

BASIC PRECAUTIONS SHOULD ALWAYS BE OBSERVED, INCLUDING THE FOLLOWING:

1. Read and follow all instructions
2. **DANGER.** To reduce the risk of injury, do not permit children to use this unit unless they are supervised at all times
3. Use this unit only for its intended use as described in this manual. Do not use attachments that are not recommended by the manufacturer.
4. Never drop or insert any object into any opening.
5. The unit must be connected to an electrical supply circuit that is protected by a ground fault circuit interrupter.

Save these instructions

**Warning**

1. Hot water is dangerous and should be checked **BEFORE** using.
2. The maximum temperature of the water should never exceed 100 degrees F.
3. Always enter and exit the Foot Spa slowly and carefully.
4. **NEVER** bring and / or operate any electrical devices into or near the Foot Spa.

GROUNDING METHODS

Because this unit must be connected to a circuit with a ground-fault circuit interrupter (GFCI), DO NOT use a grounding adapter.

The use of a grounding adapter is prohibited in Canada by Part I of the Canadian Electrical Code.

GROUNDING INSTRUCTIONS

This appliance must be plugged into an outlet equipped with a ground-fault circuit interrupter. The ground-fault interrupter can be in the outlet shown in illustration A or in the circuit breaker (fuse) box. If your outlet or circuit breaker (fuse) box is not equipped with a ground-fault interrupter, you must have your electrician install one (5 amps/unit required).

In the event of an electrical short-circuit, the ground-fault circuit interrupter will turn off the electrical power to the unit immediately, greatly reducing the likelihood of serious injury. This appliance is for use with a nominal 120-volt circuit and has a grounding plug that looks like the plug illustrated in the sketch. The outlet must be properly installed and grounded in compliance with all local codes and ordinances.

If it is necessary to use an extension cord, use only a three-wire extension cord that has a three-blade grounding plug and a three-slot receptacle that will accept the plug on the appliance.

Replace any damaged cord.

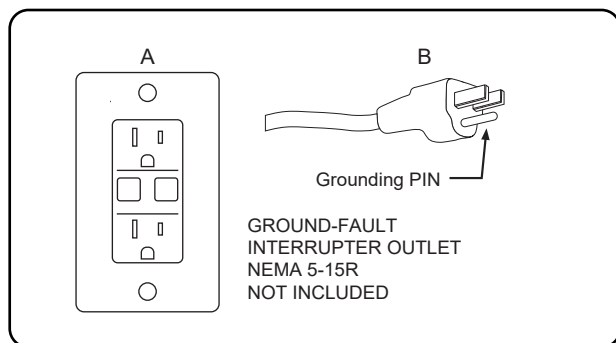

COMPLIANCE WITH LOCAL CODES AND/OR INSPECTIONS IS THE RESPONSIBILITY OF THE PURCHASER AND/OR INSTALLER.

OPERATION AND USE INSTRUCTIONS, (READ AND FOLLOW ALL INSTRUCTIONS)



Warning

IMPORTANT! At the end of the day, **ALWAYS** turn the main power OFF! including the power switch on the chair.

1. **DANGER:** To reduce the risk of injury, do not permit children to use this unit unless they are closely supervised at all times.
2. **CAUTION:** This unit should not be used by persons with open wounds, cuts or sores on their feet or legs, or by persons with poor circulation, or by persons with heart conditions. If in doubt, the client should consult with his or her physician.
3. Use this unit only for its intended use as described in this manual. Do not use attachments not recommended by the manufacturer
4. Do not operate with a damaged cord or plug. If unit malfunctions or is damaged in any manner, contact an authorized service representative for examination or repair.
5. Never drop or insert any objects into any opening.
6. Water temperature should be checked before use. Water temperature should never exceed 100 degrees Fahrenheit.
7. Never bring any electrical devices into the unit or operate electrical devices near it.
8. The unit must be connected to a supply circuit that is protected by a ground-fault circuit interrupter (GFCI).
9. Connect the unit only to a properly grounded outlet. See grounding instructions.
10. Close supervision is necessary when the unit is used by, on or near children or invalids.

IDENTIFY YOUR FOOT-SPA

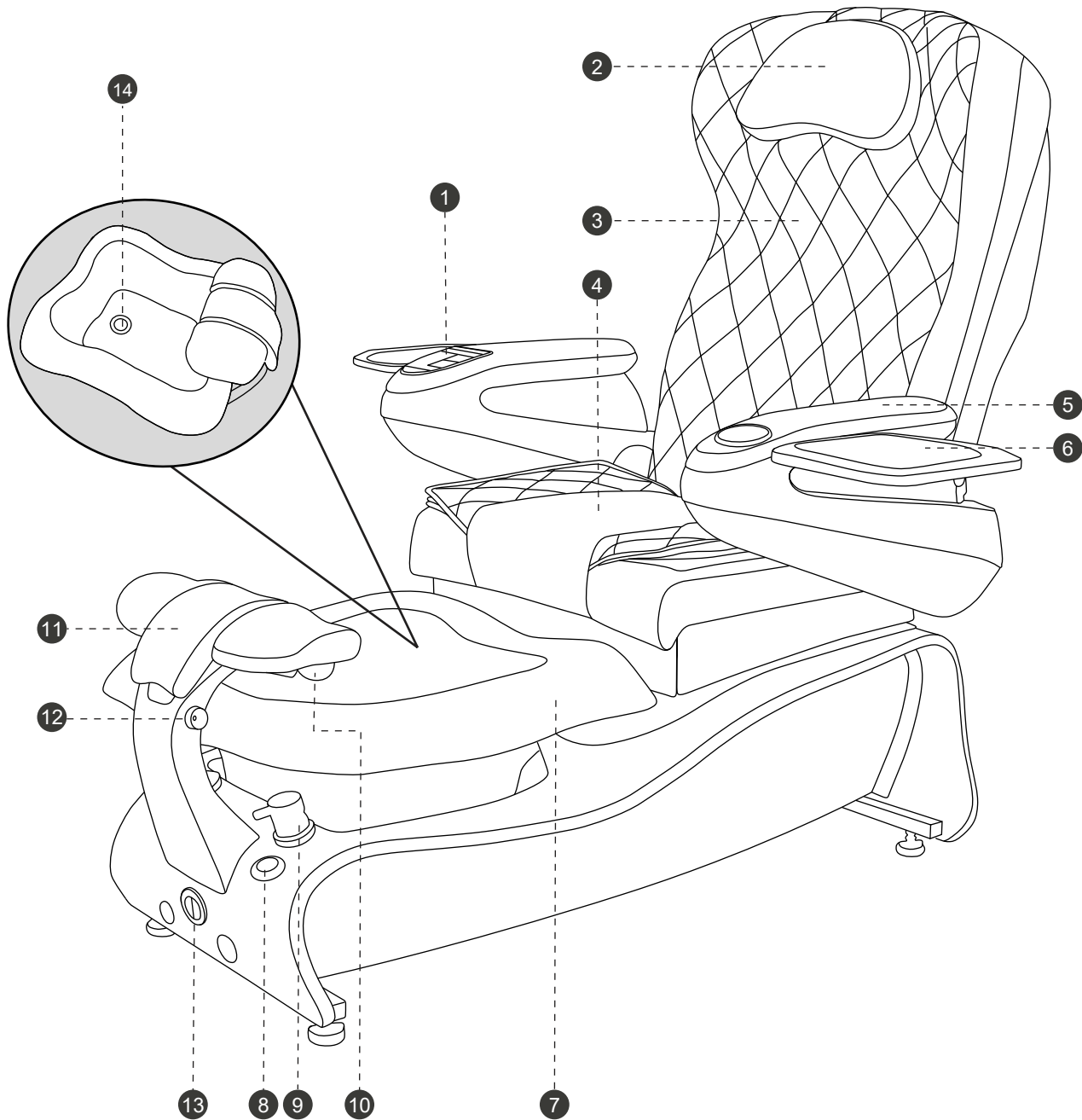

- 1. Integrated Remote Control
- 2. Headrest Pillow
- 3. Back Cushion & Massage
- 4. Seat Cushion
- 5. Wooden Armrest
- 6. Manicure Arm Tray
- 7. Glass Bowl
- 8. Waterdance System (ON/OFF)

- 9. Water Mixer Control
- 10. Hand Spray under Footrest
- 11. Adjustable Footrest
- 12. Waterdance Air Outlet Socket
Do NOT pour water down Air Outlet Socket
- 13. Chair forward and backward button
- 14. Drain

SEAT OPERATION

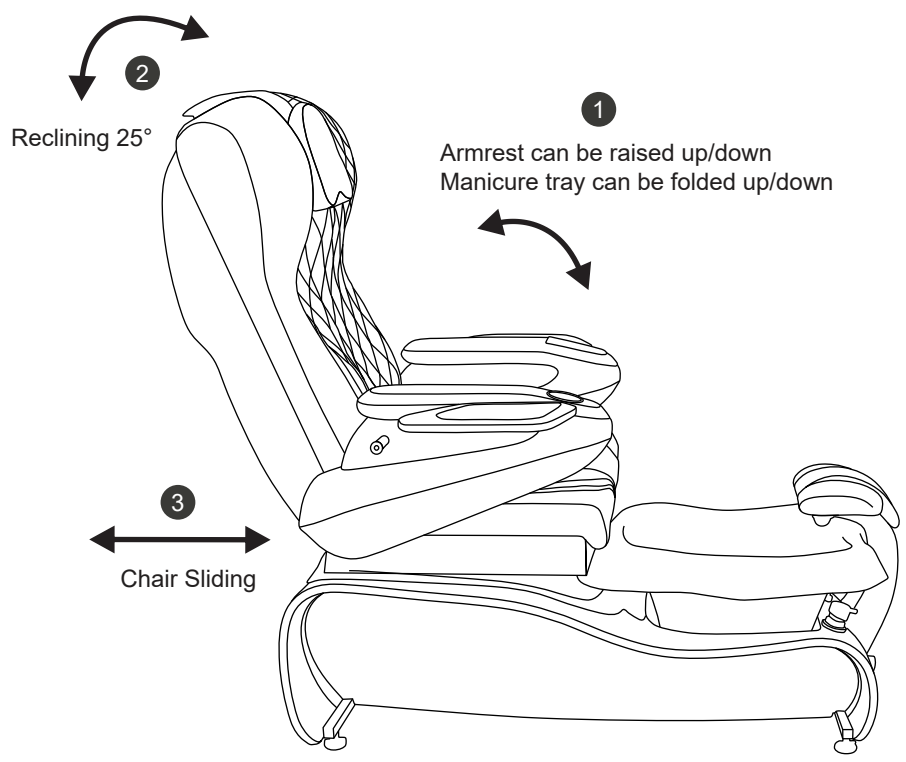

SPA DIMENSION

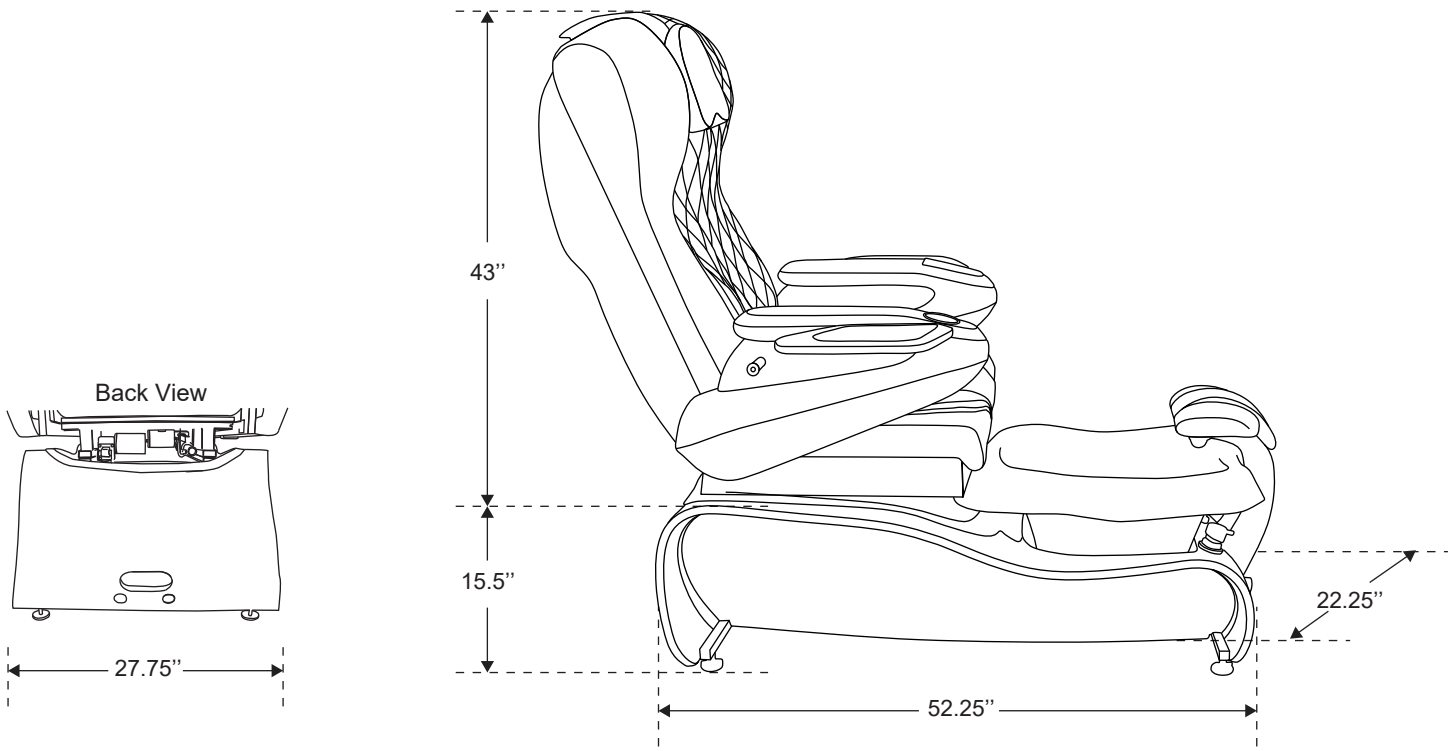

FOOT-SPA CLEARANCE

WALL CLEARANCE

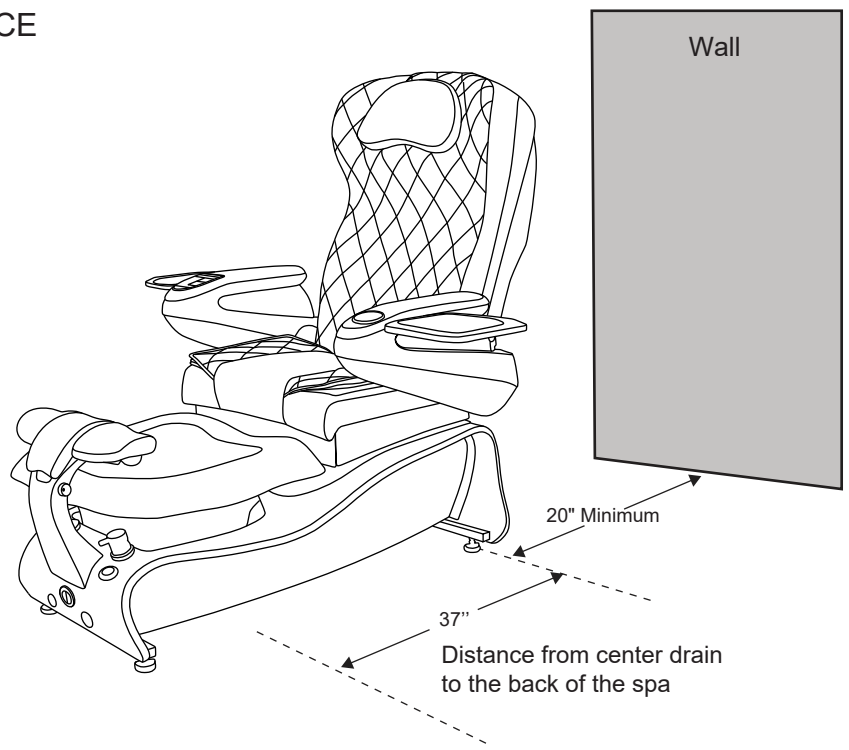

TYPICAL FOOT-SPAS

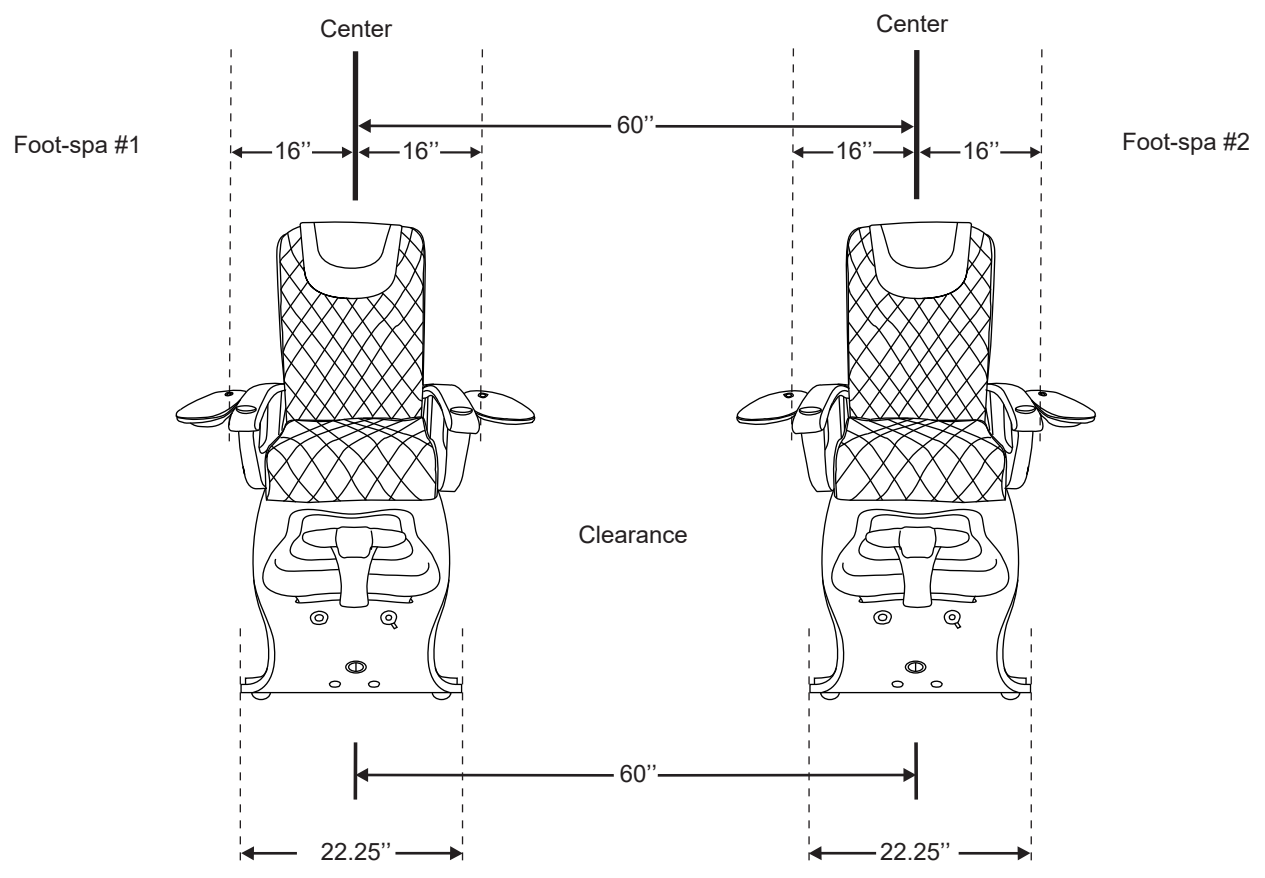

Attaching The Seat to The Base

Align the seat with the pre-drilled holes on the base then tightly secure with the nuts and bolts provided.

Attach trays or remote stand to armrest with screws provided.

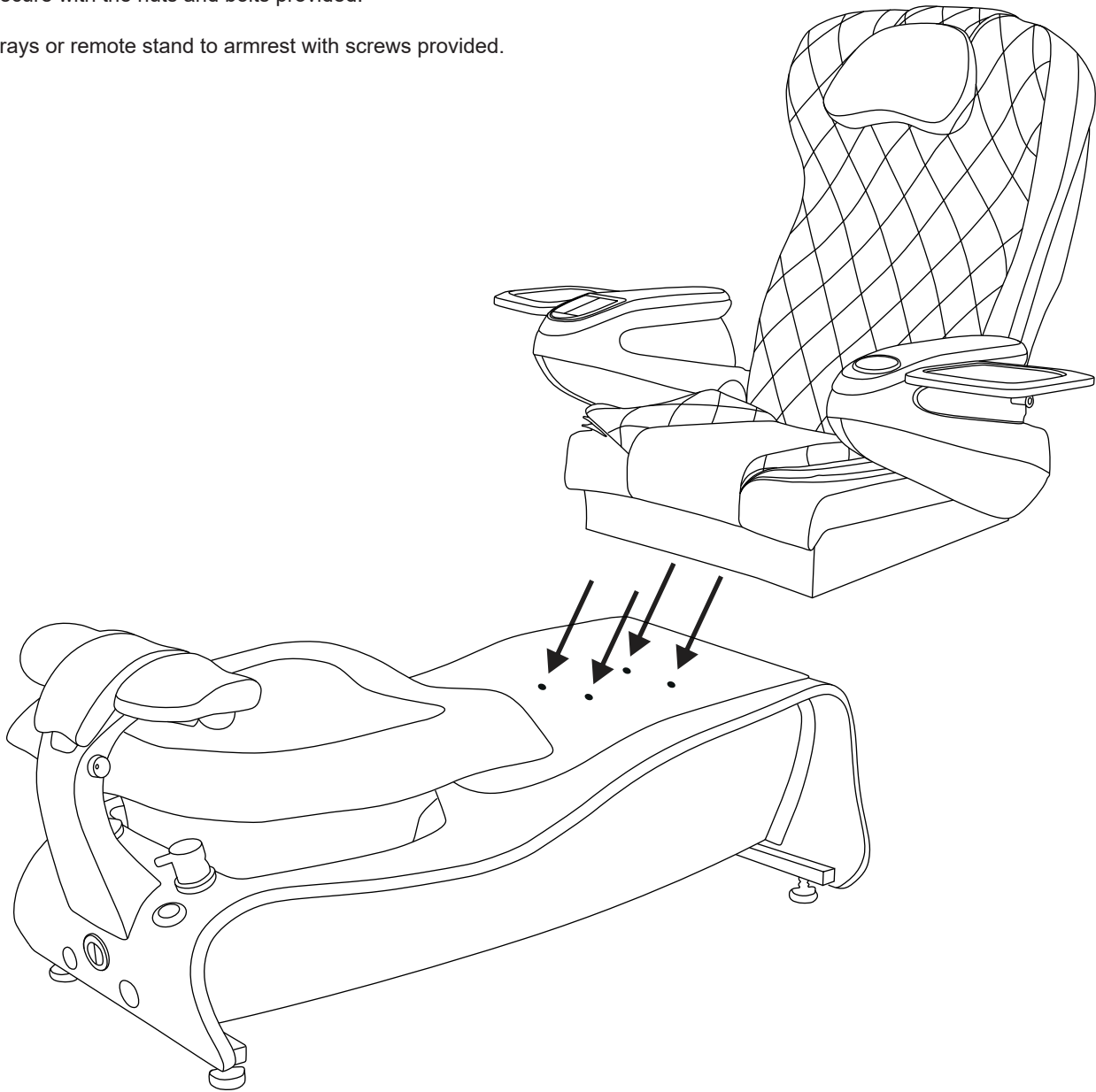

WaterDance Bubbler System

Please follow the procedure below to operate Gulfstream Inc's all-new WaterDance Bubbler System.

1. Operation:

a. Install the liner on the bowl

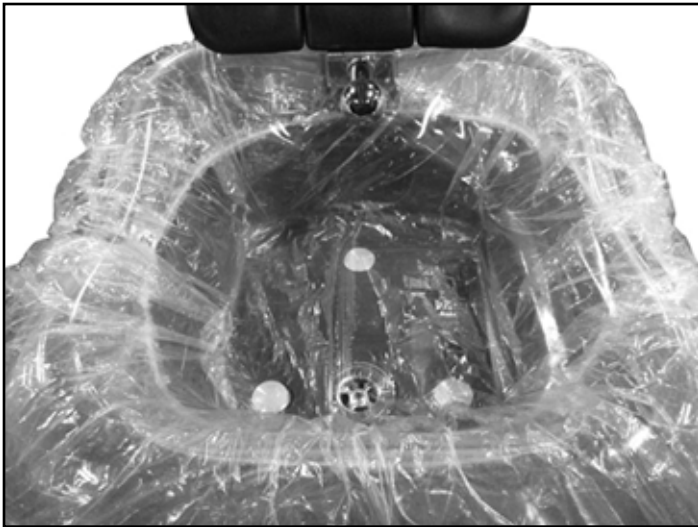

b. Hold the tab and peel off the white backing of the AirPad – Take care not to touch the adhesive surface



- c. Turn the AirPad so that the air tube is nearest to the side of the footrest with the air outlet then place the adhesive face down to stick the AirPad on top of the liner, at the bottom of the bowl.
- d. Apply uniform pressure across the top surface of the AirPad to ensure proper adhesion between the AirPad and the liner.



e. Take the included extension air tube and connect the AirPad's air tube to the extension tube's end with the soft connector by simply pushing each air tube's end until they meet in the centre of the connector.

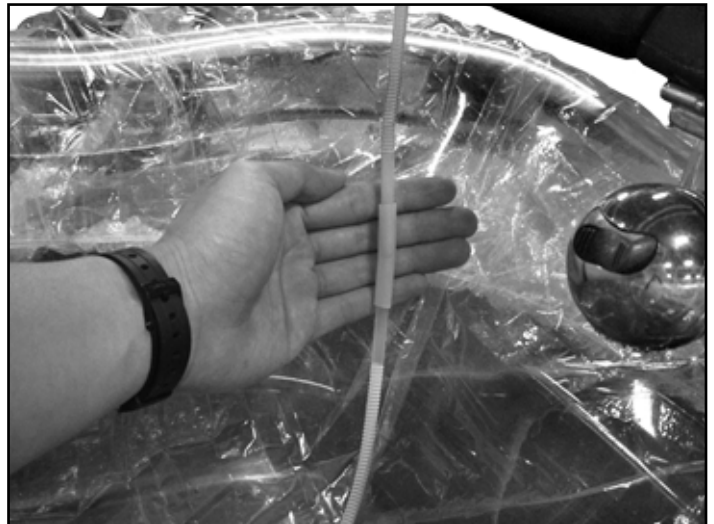

- f. Plug the free end of the extension air tube to the air outlet located on the footrest by pushing it into the opening until snug – Do not push the tube in too far.



- g. Open the mixer handle to fill the bowl with water to the desired level.



- h. Press and release the “J” button once to start the system.
i. To stop the system, press and release the “J” button again.



NOTE: For WaterDance Bubbler System with optional automatic timer of 30 minutes:

- Pressing and releasing the “J” button will start the system
- After 30 minutes, the system will shut off automatically
- To run the system for another 30-minute cycle, simply press and release the “J” button again – the system can be restarted as many times as necessary to complete the pedicure session.
- During the 30-minute cycle, the system can be turned off at any time by pressing and releasing the “J” button.

2. After the pedicure session:
- a. Tear or punch the liner at the drain opening to drain out water.
 - b. Unplug the extension air tube from the air outlet on the footrest by pulling the tube straight out.
 - c. Once water has been drained, the AirPad and the liner can be disposed in accordance with local requirements.

Plumbing Connections

1. Gravity drain uses a standard gravity drain. A floor drain is recommended. P-Trap is not installed nor supplied. The floor drain should already have a P-Trap and the UPC codes do not allow double P-Traps in the system.
2. Hot and cold water supply connections are located at the rear of the unit ($\frac{1}{2}$ " fittings). Please be advised that the hot and cold water supply lines are not fitted with optional back flow Preventers unless ordered at initial sale.
3. Have a qualified licensed electrician to install the wiring according to local codes. The Waterdance, 120V A.C., 60HZ. GFI protected circuit must be used to supply power to the unit. The roller back massage chair uses a 115V A.C. supply.
4. Spa base should be anchored securely to the floor. The base may be anchored through the opening in the back of the base wherever access is convenient for the installer.
5. Hand held sprayer is Model ST700.20. It has complied with applicable requirements of ASME A112.18.1-2005/CSA B125.1-05

FAILURE TO ANCHOR THE BASE MAY RESULT IN PERSONAL INJURY OR DAMAGE TO THE UNIT. DAMAGE AS A RESULT WILL VOID THE WARRANTY.

Typical Gravity Sink (Direct Drain) Installation

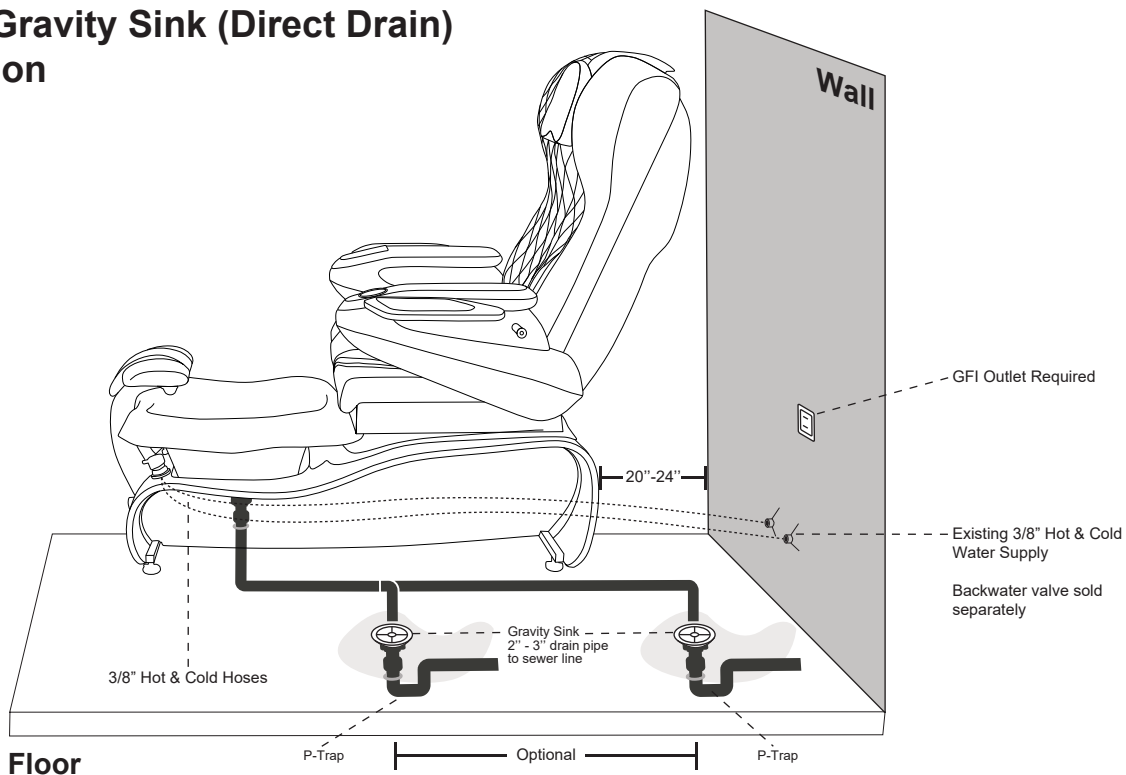

P-Trap supplied by plumber

Typical Gravity Sink (Direct Drain) Installation

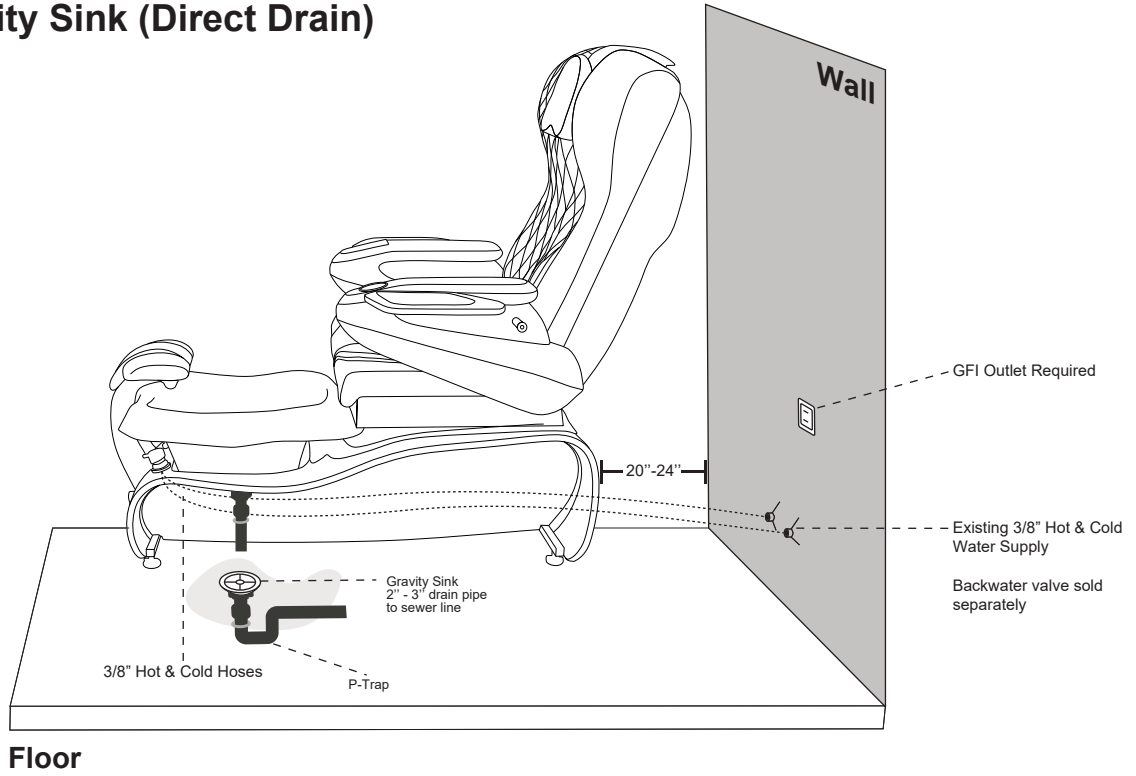

P-Trap supplied by plumber

Control Panel

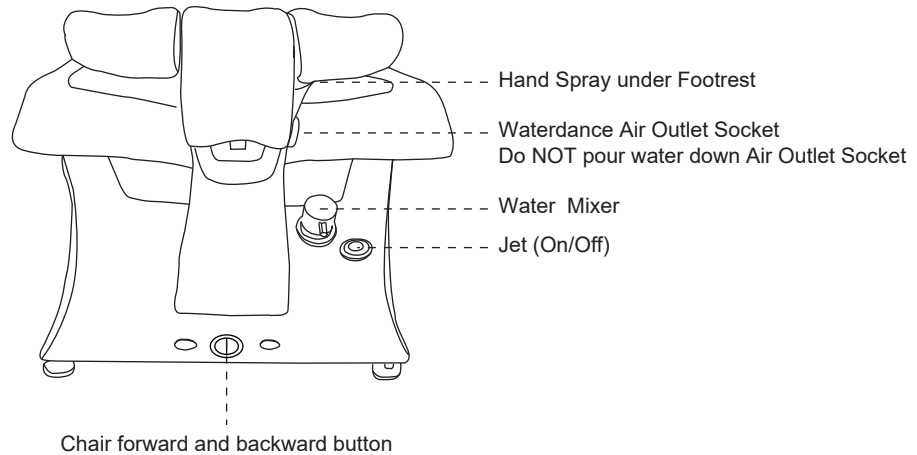

1. To fill water:

The foot-spa is provided with a single hot and cold mixing valve located on the front of your spa. This is a pressure balance valve that requires you to lift the handle to start the water flow and to adjust to the temperature that is desired.

CAUTION: DO NOT USE FOAMING, SUDSING OR MINERAL OIL BASED ADDITIVES IN THE WATER.

2. To drain Footspa bowl:

Turn drain control knob to "pop-up" drain plug.

3. The Shiatsu Roller back massage Chairs are equipped with a state-of-the-art robotic massage system. This system is easy to use. The remote has a one-touch power button that initiates a pre-programmed massage session. Various massage functions are also available for selection via this remote. The chair's position can also be adjusted; forward/backward as well as reclined to the client's preference (see illustrations on page 12).

Note: Read and Follow Chair Manual Instructions

BASIC PRECAUTIONS SHOULD ALWAYS BE OBSERVED, INCLUDING THE FOLLOWING:

1. Read and follow all instructions
2. **DANGER.** To reduce the risk of injury, do not permit children to use this unit unless they are supervised at all times.
3. Use this unit only for its intended use as described in this manual. Do not use attachments that are not recommended by the manufacturer.
4. Never drop or insert any object into any opening.
5. Do not block jets during operation.
6. The unit must be connected to an electrical supply circuit that is protected by a ground fault circuit interrupter.

Shiatsu Remote Control

Please refer to instruction manual for operations

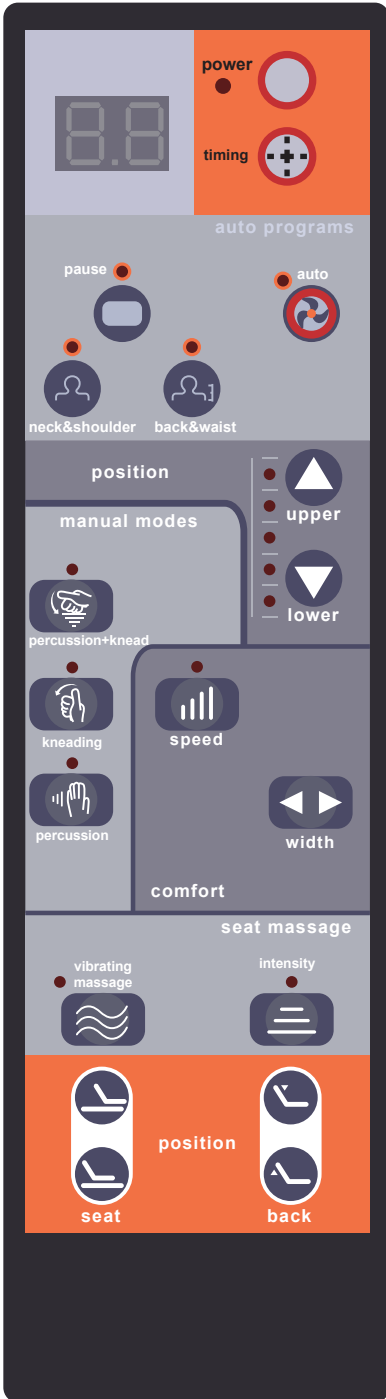

9620-1



LED Trim Remote
(LED Light
with wireless remote
are optional.)



9660



A conveniently located auxiliary button to help the technician move the customer's seat back/forward easily. Available for 9660 Chairs.

Gulfstream Inc. highly recommends the following cleaning regimen. You should always contact your local governing agency for their specific cleaning and disinfecting requirements and regulations for pedicure spas. For your clients safety, always use the regulations as a minimum standard for cleaning and disinfecting. Combining your states standards with the regimen listed below will provide your clients with a safe and healthy pedicure spa environment experience.

Routine maintenance:

Powdered cleansers or abrasives are **NOT RECOMMENDED**. A clean towel or sponge, are all that are usually needed. A soft bristled brush may be used when excessive residue is present. Use a mild soap and water solution to clean the upholstery, but do not over wet. Wipe dry with a clean towel. No internal maintenance of the spa components are necessary. For extra protection, our recommendation is that the system be flushed daily or weekly depending on use.

NOTE:

Cleaning or sanitizing is NOT disinfecting. According to the Centers for Disease Control and Prevention (CDC), and the US Environmental Protection Agency (EPA), disinfecting occurs only when there is a reduction of pathogenic microbes at 99.999%. Sanitizing is only a reduction of 99.9%. Cleaning of whirlpool pedicure spas requires surfactant and chelating detergents that are low-foaming and have the ability to remove body oils, organic oil additives, mineral oil, skin cells, nail clippings etc. that can accumulate both in the basin which may become a fertile area for micro organisms to grow.

Adherence to the above cleaning will minimize build up. Gulfstream Inc. does not recommend the use of mineral oil based products.

TESTING/FLUSHING FOOT SPA

Test for leaks without the liner (drainage) by filling the bowl and inspecting under the spa unit.

Gulfstream warrants to the original purchaser that the new pedicure spa will be free from defect during the Standard Warranty Period (listed below). The shipping date and the uniquely-coded Serial Number on the back of each spa chair will justify the start of the warranty period for the product. The warranty is null and void if the pedicure spa is taken from its initial place of installation, or it is not installed in accordance with federal, state or local codes and ordinances. Also, this warranty does not apply if the pedicure spa has been subject to misapplication, improper installation or maintenance, negligence, improper cleaning or other circumstances beyond Gulfstream's control.

Warranty

1. Limited Three(3) Years warranty on Spa Shell.
2. Limited One(1) Year warranty on the Waterdance.
3. Limited One(1) Year warranty on the Glass Bowl.
4. Limited One(1) Year Parts-Only warranty which covers the Hydraulic System, Electrical Components.
5. Gulfstream will pay standard shipping charges on all replacement parts during the first 90 days of the stated Warranty Period. After 90 days the consumer is responsible for all labor and shipping costs incurred.

Exclusions

1. Damage to pump parts and/or motor parts due to obstruction in plumbing lines etc.
2. Staining, fading or discoloration of plastic surfaces due to exposure and/or the use of harmful cleaning agents or chemicals.
3. Staining, fading or discoloration caused by improper or poor water additives not related to the maintenance of proper water are not covered by this warranty.
4. Staining, fading or discoloration of the seat, armrests or footrests.
5. Freight damage, misuse, neglect, accident, natural disaster and abuse.
6. Unauthorized repairs.

Service

1. The Dealer shall forward all warranty-related matters to our Customer Service Department.
2. Serial Numbers and Original Invoice must accompany all warranty claims.
3. Customers are responsible for shipping defective parts back to Gulfstream. These parts must be packaged correctly in order to protect against any further damage.
4. All parts are to be shipped by UPS Ground Service, average 2-5 days.
5. All defective parts must be shipped back to Gulfstream within 30 days of receiving the new replacement parts or warranty will be void.
6. Any warranty claim that cannot be determined over the phone, the customer must send photos and original invoice directly to Gulfstream before any repairs can be performed.
7. Any service performed on the product without Gulfstreams authorization will also void the Warranty.
8. Each service call from the customer will be assigned a Claim Number. The Claim Number will stay open until the problem is resolved.

No dealer or other person has any authority to bind Gulfstream Inc. to changes or additions to this warranty or its products. Accordingly, Gulfstream Inc. Is not responsible for such warranties or representations.



Manufacturer of Luxurious Pedicure Spas,
High Quality Salon and Spa Furniture.

WATERDANCE[®]

S Y S T E M

Gulfstream Inc.

Cambridge, Ontario, Canada N1R 5X5

Tel.: 519-622-0950

Fax: 519-622-6926

www.gulfstreaminc.com

WATERDANCE[®], FLORENCE[™], Gulfstream Inc.[®] are trademarks of Gulfstream Inc.

Patent #D709619, #8726430, #8680699, #D701318, #8662848, #8531048, #8366418, #D670938, #D670354, #D662340, #D660444, #D650084, #D646082, #D636090, #D632798, #D628704, #D615326, #D613099, #D612509, #D610697, #D600950, #D596883, #D596882, #D590188, #D589285, #D588844, #D583960, #D583576, #D583171, #D565739, #D556480, #7111334, #6991182

© 2019 All rights reserved. Design and Specifications are subject to change without notice.