

Osaki **Massage Chair** **OSAKL Pro-paragon** **User 's Manual**

*Make your life healthy
and beautiful every day!*

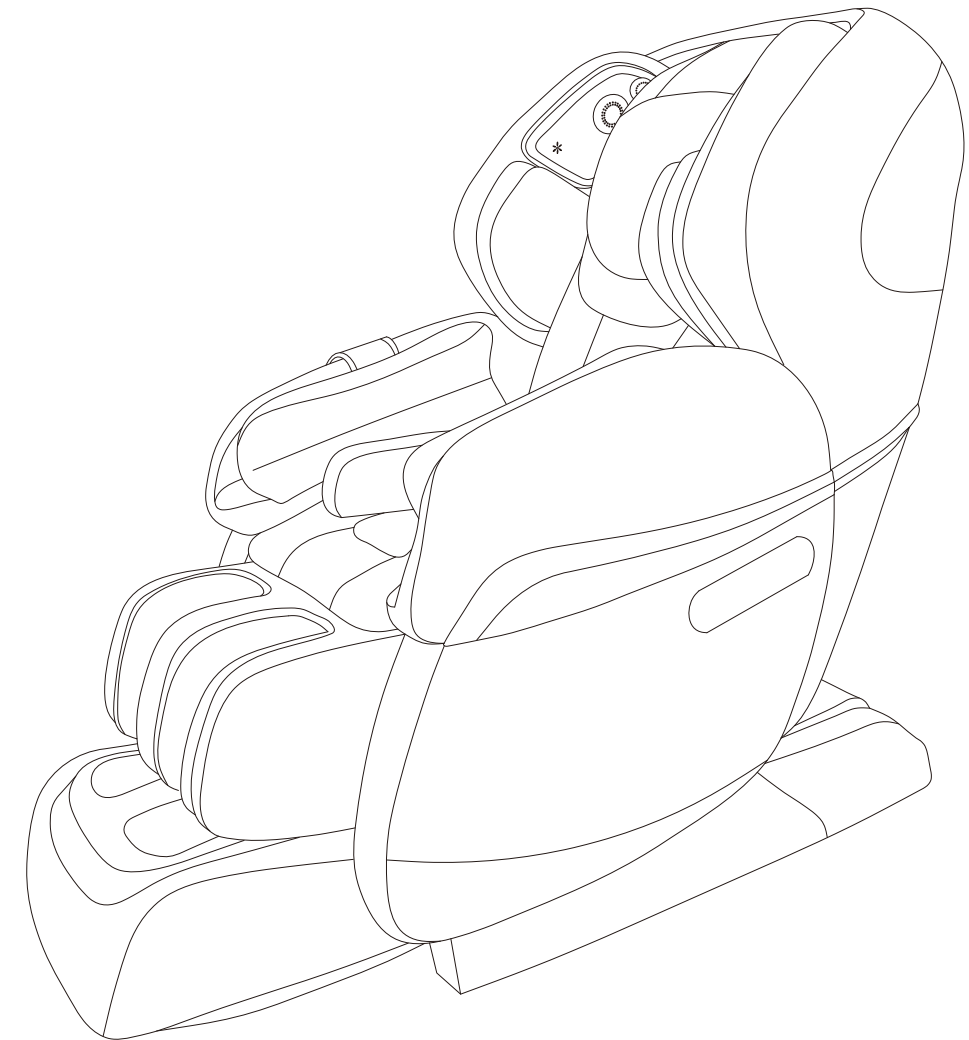

Please read SAFETY INSTRUCTIONS carefully before using the chair.

Massage Chair

OSAKL Pro-paragon

Function Introduction

1. Combined with national-patent 4D flexible swing massage mechanism at the back, the massage chair is designed with functions such as kneading, tapping, shiatsu, knocking and quick rubbing user's back, creatively imitate human hands compound kneading technique, offers comfortable body massage.
2. Designed with heating ball on massage machine, it can do heating therapy on neck, shoulder, waist and buttocks, relieve pain and promote blood circulation.
3. Super long L-shape rail design, rollers moving from top to seat area can achieve any angle massage to the thighs, experience the comfort of the whole body massage.
4. Micro space forward sliding function, it can put the massage chair close to the wall, saving space, make you enjoy the massage within limited home space.
5. One-touch key lying down to flat angle and true zero gravity function can effectively relieve pressure on the spine and joints, enjoy the physical and mental relaxation of the comfortable feeling; footrest lifting position is a little higher than the user's heart position at recline angle of the backrest, which can provide more oxygen to the brain.
6. Simple hand controller with full-color LCD screen can display massage positions, techniques and status in real-time. It can have personalized custom massage program.
7. Wireless Bluetooth music player can effectively adjust the mood, ease mental fatigue.
8. Innovative leg rubbing technology, leg muscles rubbing massage can effectively improve the leg pain effect, restore health and vigorous of legs.
9. With omnibearing rolling and air pressure massage function in foot parts, stimulate the foot reflection zone by foot roller heating function.
10. Air pressure squeezing massage on your arms, which can promote blood circulation of blood capillary.
11. Equipped with multiple sets of airbags in waist and hip parts, which can completely cover the waist, hip and thigh parts, to effect air pressure squeezing massage alternately, and relieve the fatigue effectively.
12. Footrest can be extended and retracted within the range of 22 cm, suitable for different height people to use.
13. Following user's voice guidance, intelligent voice activation technology can make you enjoy a comfortable massage service.

- ★ 1.Thank you for choosing this Massage Chair .
- 2.Please read this manual carefully before using the massage chair.
- 3.Please keep this manual in a safe place for further reference.
- 4.Please pay attention to SAFETY INSTRUCTIONS.

- ★ Note: We reserve the right for design modification. It is subject to change without notice. The pictures in this manual are only for reference. Please refer to the actual product.



Content

Preparation	Safety instructions -----	1
	External structure parts -----	5
	Internal structure parts -----	6
	Mechanical components diagram -----	7
	Mechanical components list -----	8
Installation	Installation -----	9
Massage Operation	The adjustment before massage -----	15
	Manual control -----	17
	Operation instruction &function illustration -----	21
	After massage -----	24
Maintenance	Clean and maintenance -----	25
Others	Malfunction guide -----	26
	Technical data -----	27





Please keep this manual in a safe place for future reference.

- ◆ Please read this manual carefully to make sure the installation and operation of the massage chair is correct.
- ◆ “Safety Instructions” is provided in both Warning and Caution for important safety information.

Both Warning and Caution are important safety caution, please pay more attention.

 Warning	This sign indicates warning of causing possible death or hurt to body.
 Caution	This sign indicates caution of causing possible hurt or damage to things.



Symbol meaning

	This sign indicates forbidden behavior.		This sign indicates self disassembly is forbidden.
	This sign indicates must follow instruction to operate.		This sign indicates correct operation of cable.

- ◆ The following should be kept for any further references.



Warning

	<ul style="list-style-type: none"> ● Osteoporosis patient ● People with heart disease including embedded pacemaker or other medical electronic device inside the body. ● For pregnant women or people not healthy, please consult doctor before use. ● Do not use the chair when the skin damage. ● Patients with a high fever forbid to use this machine. ● Perceptual disabilities patients forbid to use this machine. ● People over 80 years old forbid to use this machine. ● Kids and the drunk people are not allowed to use the chair. ● Please don't sleep in the chair. ● Don't use the chair when your body is wet. ● Those who are not sensitive to the heat or allergic to the heat must be careful when using it, or do not use. 	People who are not suitable to use the chair
	<ul style="list-style-type: none"> ● Make sure there are no kids or pets or other objects around (under, behind or in front of) the chair at the moment of backrest, leg-rest up/down or leg-rest retraction/extension from reclining position. ● During operation, if you have body abnormal, please stop the operation and go to consult your physician. ● Please do not take strong massage on the head. ● Do not massage belly or knees, be careful when massage neck. ● Children or pets are not allowed to play on the chair especially during massage. Standing or sitting on the back or armrest is not allowed either. ● Those who move around difficulty or can't express themselves must be taken care of strictly and continuously during massage. 	Accident/injury
	<ul style="list-style-type: none"> ● Insert the plug of the chair into correct and suitable power socket. Make sure the plug is completely inserted into the socket to reduce short circuit or fire risk. ● Unplug the power when not in use, stop all massage functions and turn off on/off key before unplugging. 	Fire and electric shock
	<ul style="list-style-type: none"> ● It is prohibited to use the massage chair while any items covered the massage chair ventilation holes. ● Massage cushions of the chair are not allowed to fold for storage. ● The machine is forbidden for no-load running for a long time. ● Power cord, plug, socket can't be used in broken or loose contact condition. ● Don't use other electric power except rated voltage in case of fire, electric shock or any breakdown. ● Any broken, re-process, knotted, twisted power cord or pressed under heavy cargo is not allowed to use. 	Accident Fire and electric shock
	<ul style="list-style-type: none"> ● If the chair works dysfunctional, or is broken, splashed with water or falls into water, please have it repaired by professional repairman or send the chair to assigned service agent. Self-modification, disassembly or maintenance is forbidden. ● If power cord or plug is damaged, please don't replace it yourself, please contact us or appointed dealer for replacement. ● To avoid electric shock or body hurt, please don't open or disassemble any part of the chair, there is not any attached part of the chair for maintenance by customers. ● Check leather or cloth material on the back and other areas is broken or not. If broken, even though it is small, please stop using the chair, unplug the power and have it repaired 	Disassembly and maintenance

**Caution**

	<ul style="list-style-type: none"> ● Please operate the chair in a flat or level place 	To avoid sudden falling.
	<ul style="list-style-type: none"> ● Position the chair 10cm from the wall to allow for sufficient space to recline up and down. 	To make sure the back lying.
	<ul style="list-style-type: none"> ● The maximum suggested operating time is 20mins. 5mins for each position beginning with the slight- step massage. Along continuous massage in the same position may cause uncomfortable feeling. 	Too long time massage is bad for your body.
	<ul style="list-style-type: none"> ● Before sitting on the chair to avoid injury please inspect everything to confirm that the massage heads are in the correct position. 	To avoid accidental injury.
	<ul style="list-style-type: none"> ● Hand control should be timely put into the hand control bag, do not arbitrarily put away, to avoid squeezing or drop damage. 	
	<ul style="list-style-type: none"> ● Please make sure that the power switch is at the "OFF" position before inserting the plug into the socket. 	To avoid the accident when turn on the power.
	<ul style="list-style-type: none"> ● Turn off all controls before removing plug from outlet. 	
	<ul style="list-style-type: none"> ● Make sure the plug completely insert into the socket. 	To reduce short circuits and any fire hazard.
<ul style="list-style-type: none"> ● Checking whether any damage on wire, make sure no water or rubbish on wire. ● Installing earth wire in correct way. The plug must be inserted into socket with earth connect, the earth connect couldn't be bend or cut off. 	To avoid electric shock in any leakage or breakdown.	
	<ul style="list-style-type: none"> ● Don't press with hands or step on the massage heads with feet. ● Don't put hands between the working massage heads. ● Don't put hands or feet in the gap of mechanical parts. ● Don't drop or embed anything into the slot of massage chair. ● Don't stand or sit or put anything on the backrest, armrest or leg-rest. ● Don't stand on the chair during operation. ● Don't move the chair during operation. ● Don't pull out the plug or turn off the power during operation. ● Don't put your hands or head between leg-rest or beneath. ● Don't use the massage chair while wearing hair ornaments. ● Don't put hard things in pocket when take buttocks and huckle massage. ● Don't sit or press on the backrest when the chair is in reclining position. ● Don't use at bare skin or were thin clothes, thin clothes may can achieve better massage effect, But it also may cause irritation to the skin or cryogenic burns. 	To avoid accidents or injury
	<ul style="list-style-type: none"> ● Keep the chair away from heat, wet, sharp things and corrosive, inflammable, explosive environment. ● To use electric blanket or other heating products on the chair is forbidden. ● Don't put in the space of dust serious or corrosive gas environment, ● Don't put the chair in a small space places or use in the bad air circulation places. ● Keep the chair away from stove or other heating products. ● Don't put the chair directly under the sun or other high temperature places. 	To avoid fade, discolor on upholstery or hardened, deteriorated on PU.
	<ul style="list-style-type: none"> ● Don't use the chair outdoor. 	

**Caution**

	<ul style="list-style-type: none"> ● Don't use or store the chair in the wet environment like nearing the swimming pool, or bathroom. ● Keep the chair and remote control dry all the time. 	To avoid leakage or electric shock.
	<ul style="list-style-type: none"> ● Make sure to install the earth wire in correct way (Incorrect install way may cause electric shock. If you don't know how to install, please find a professional electrician) ● Don't use plug adapter (If the enclosed plug doesn't match with socket, please don't change the plug by yourself and find a professional electrician to install a matched socket.) 	To avoid electric shock.
	<ul style="list-style-type: none"> ● Unplug the power before cleaning the chair. ● Unplug the power after using the chair. 	To avoid electric shock or fire hazard.
	<ul style="list-style-type: none"> ● Unplug the power when any damage on the power. ● Hold the plug to unplug the power but not try to pull the wire to unplug the power. 	
	<ul style="list-style-type: none"> ● Please turn off the power switch and unplug the power after massage. 	To avoid accidents
	<ul style="list-style-type: none"> ● Unplug the power immediately when electricity goes off. 	To avoid damage or accidents when power on again.

Grounding instruction

- ✧ ※The chair is equipped with a cord having a grounding conductor. The plug must be plugged into an appropriate socket that is properly installed and matched with the plug.

Replace fuse

- ✧ ※When the fuse is burned out, please turn off the switch and unplug the power. Opening the lid covered the fuse which is located in the switch box. Using a same size fuse to replace the old one, then cover the lid. Or you can find an electrician to replace the fuse.

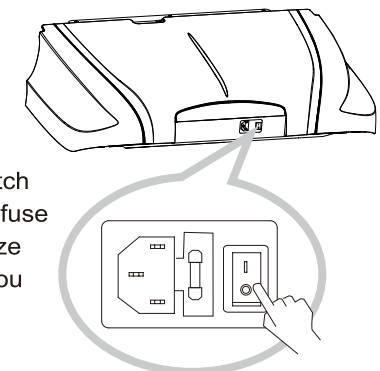

Earth wire is not allowed to be in these places

Gas pipe: probably cause explosion or fire.
Phone wire and lightning rod: probably cause electric shock and fire when thundering.
Water pipe: earth wire is useless where there are plastics

External structure

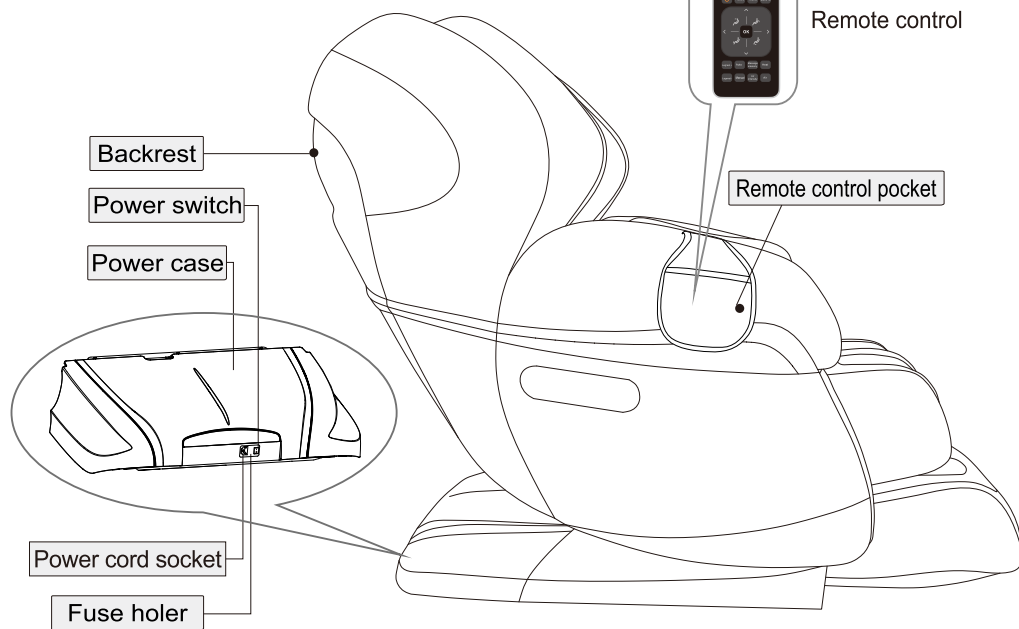
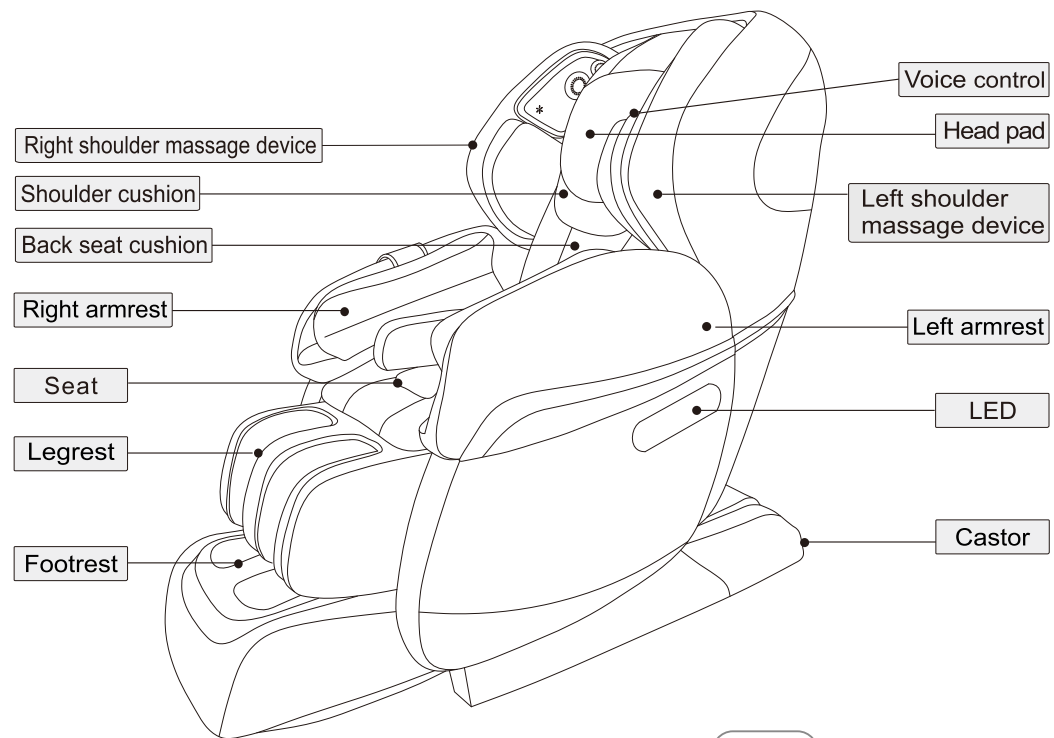

Preparation

Internal structure

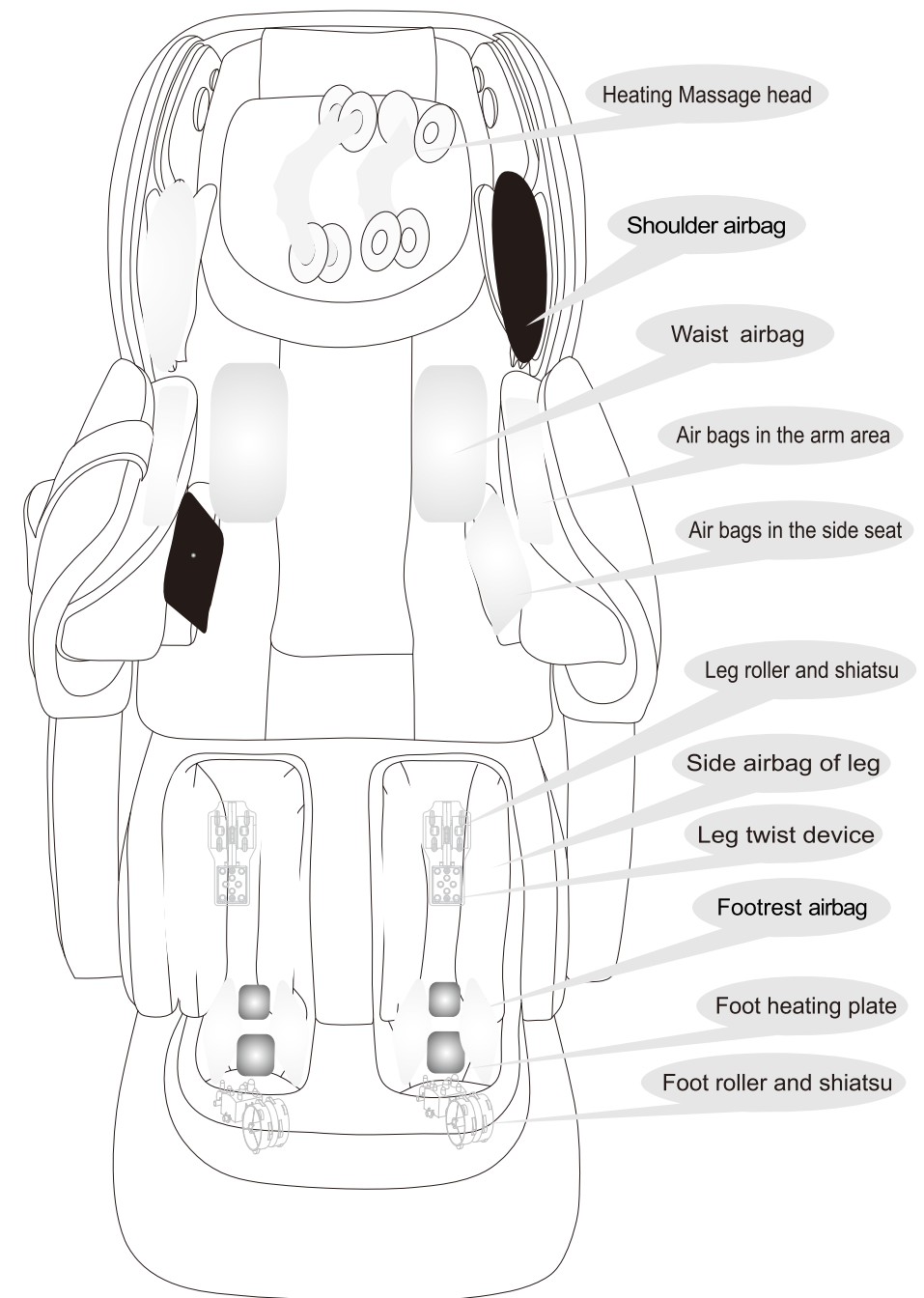

Preparation

Explosion Diagram

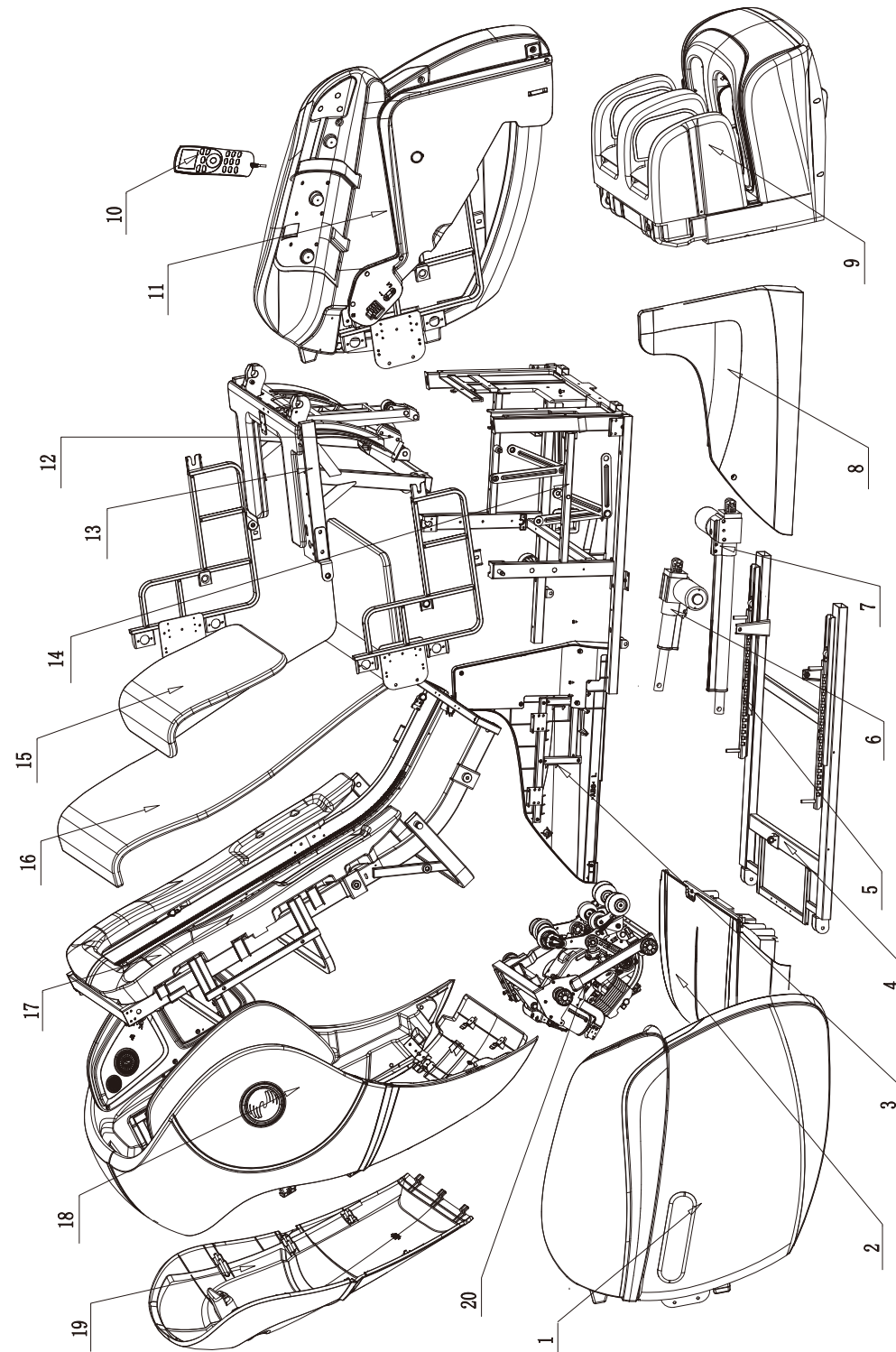

Preparation

Mechanical components list

NO.	Name	Q' ty	NO.	Name	Q' ty
1	Right armrest assembly	1			
2	Power case assembly	1			
3	Left side fender	1			
4	Base assembly	1			
5	Sliding rail	2			
6	Seat electric actuator	1			
7	Backrest electric actuator	1			
8	Right side fender	1			
9	Foot and leg assembly	1			
10	Remote control	1			
11	Left amrest assembly	1			
12	Footrest electric actuator	1			
13	Seat frame surface assembly	1			
14	Seat bottom frame assembly	1			
15	Pillow	1			
16	Back and seat cushion	1			
17	Backrest assembly	1			
18	Shoulder device assembly	1			
19	Back cover assembly	1			
20	Massage machine	1			

Preparation

Installation (1)

Step 1. Take out the main body and accessories from the carton box.

- ① Take out the accessories boxes and the main chair from the carton box by at least three people .
- ② Confirm all the accessories.

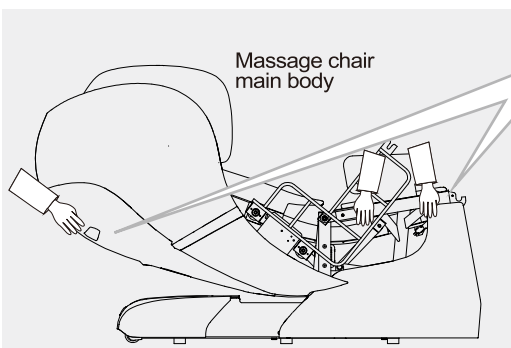

Massage chair main body

Two people grasp left and right seat metal frame ,the other one catch handling position of the back cover, then take the main body of massage chair out of the box .

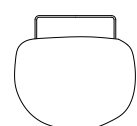
The accessories

Head pad

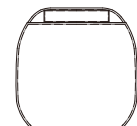

Shoulder cushion

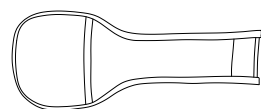

Controller bag

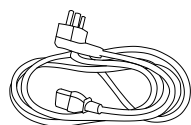

Electric power cable



Remote control

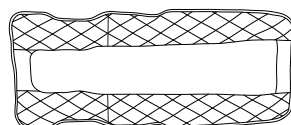

Back seat cushion

- ③ Take out the left ,right armrest from the armrest carton box,put the armrest on the table or ground in flat(pay attention to prevent scratches)

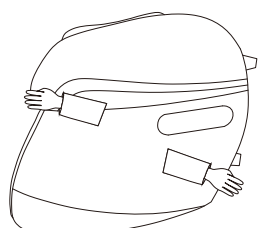

Right armrest

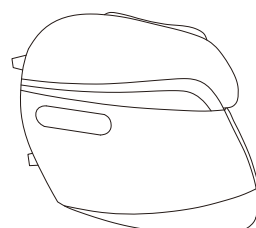

Left armrest

- ④ Taking out the legrest device from the legrest carton box,catching the front and back two sides of the legrest and take them out.

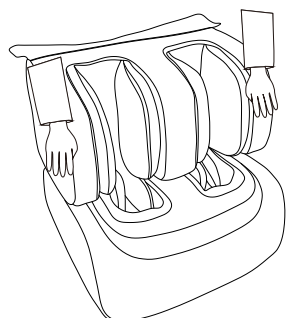

Legrest device

Installation (2)

● Check environment

- Make sure the recline space.

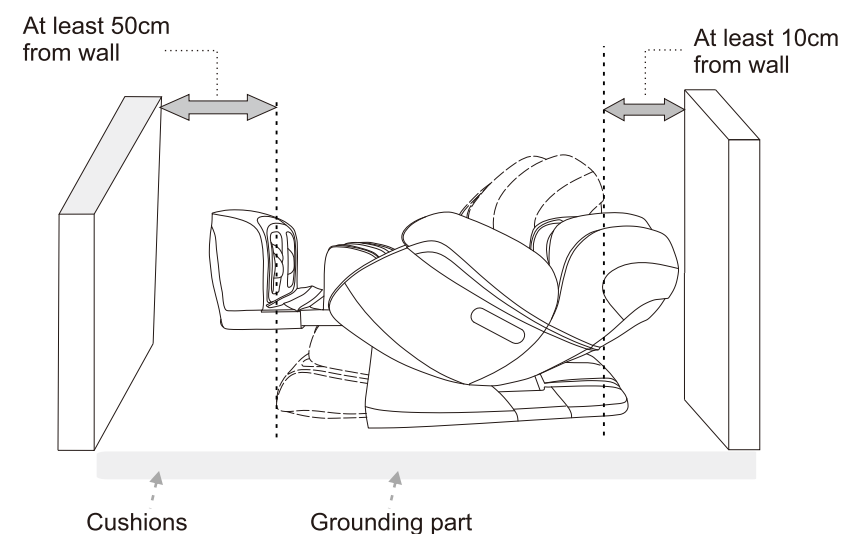

Because the chair is heavy, it may ruin your floor in long time setting. Please put a blanket or other soft things to protect your floor.

Caution:

- Don't use the chair in wet places like near swimming pool , bath room to avoid leakage or electric shock.
- Please use chair in flat place to avoid chair falling or noise or other unexpected trouble.
- Don't use under sunlight or near stove or other heating place to avoid upholstery deteriorated.

Installation (3)

Step 2. How to assemble the legrest

- ① Unscrew the bolt from hanger of legrest.
- ② Connect the legrest's air hose with the corresponding air nozzles of the main body tightly.
- ③ Connect power line with power socket tight.
- ④ raise the rotation shaft board on hangers, raise the legrest with hands, put rotation shaft into hangers on main body, and put rotation shaft board down.
- ⑤ Screw it back tight.
- ⑥ Connect the legrest leather piece with seat by velcro .

⚠ Caution: Make sure the air tube and wires cannot twist together.

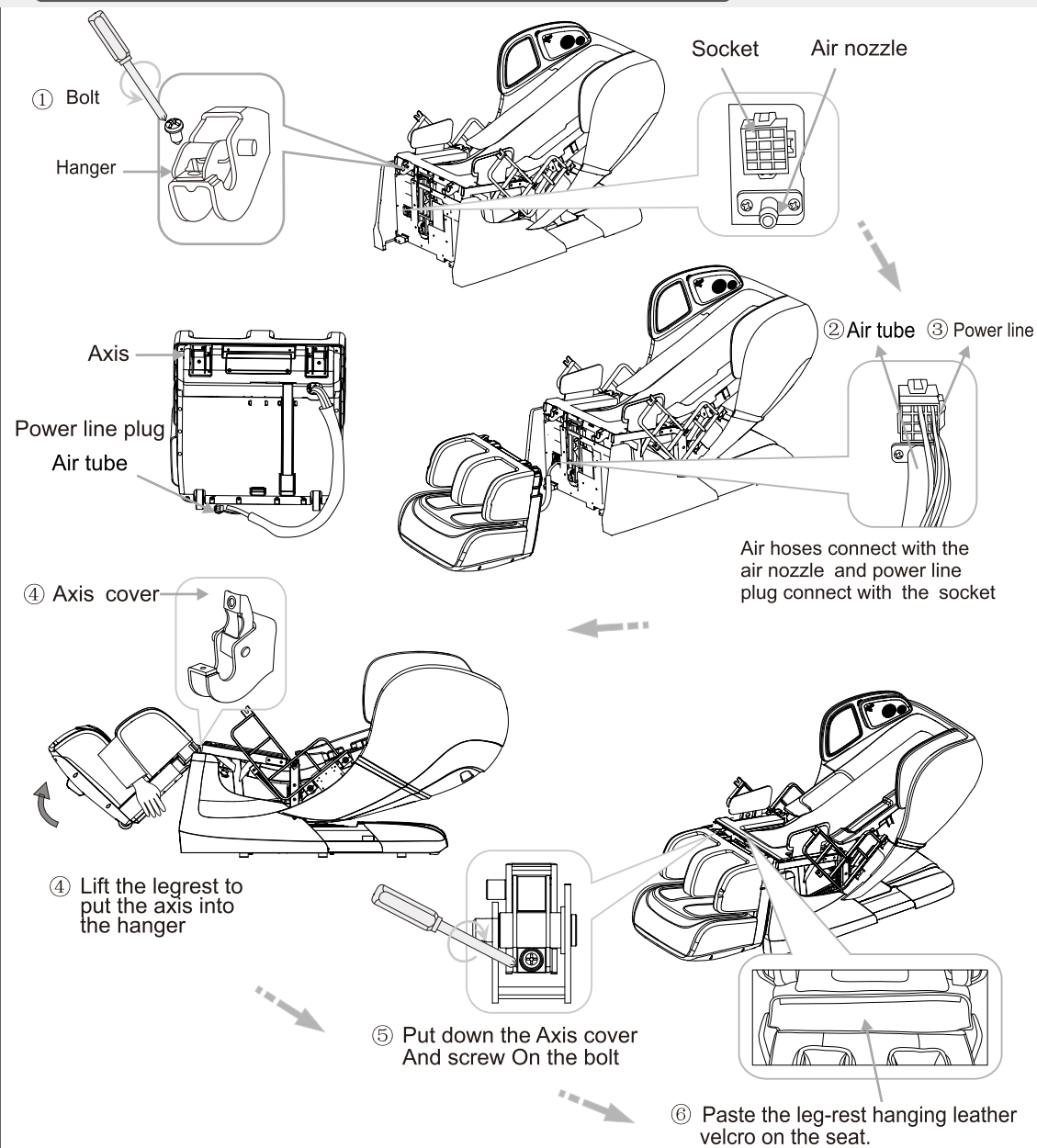

Installation (4)

Step 3. How to assemble the left and right armrest

- ① Lift the armrest and plug it into the rotating stand on the side of the chair body.
- ② Put the power plug into the socket.
- ③ Connect the air hose of armrest with the air tubes on the seat tightly, the black air tube should be connected with the air hose marked with "1" and the grey air tube should be connected with the air hose marked with "2".
- ④ Insert the rear armrest fixed plate into the fixing hole on the chair body.
- ⑤ Remove the rubber plug of the armrest, spin the screws inside the hole tightly then put on the rubber plug tightly.

⚠ CAUTION: Do not squeeze the air tubes during the installation. This may cause air leakage or the air bags are not inflatable. Please make sure that the fixed plate and LED wire need to be plugged firmly, otherwise the armrest may drop or LED light does not shine.

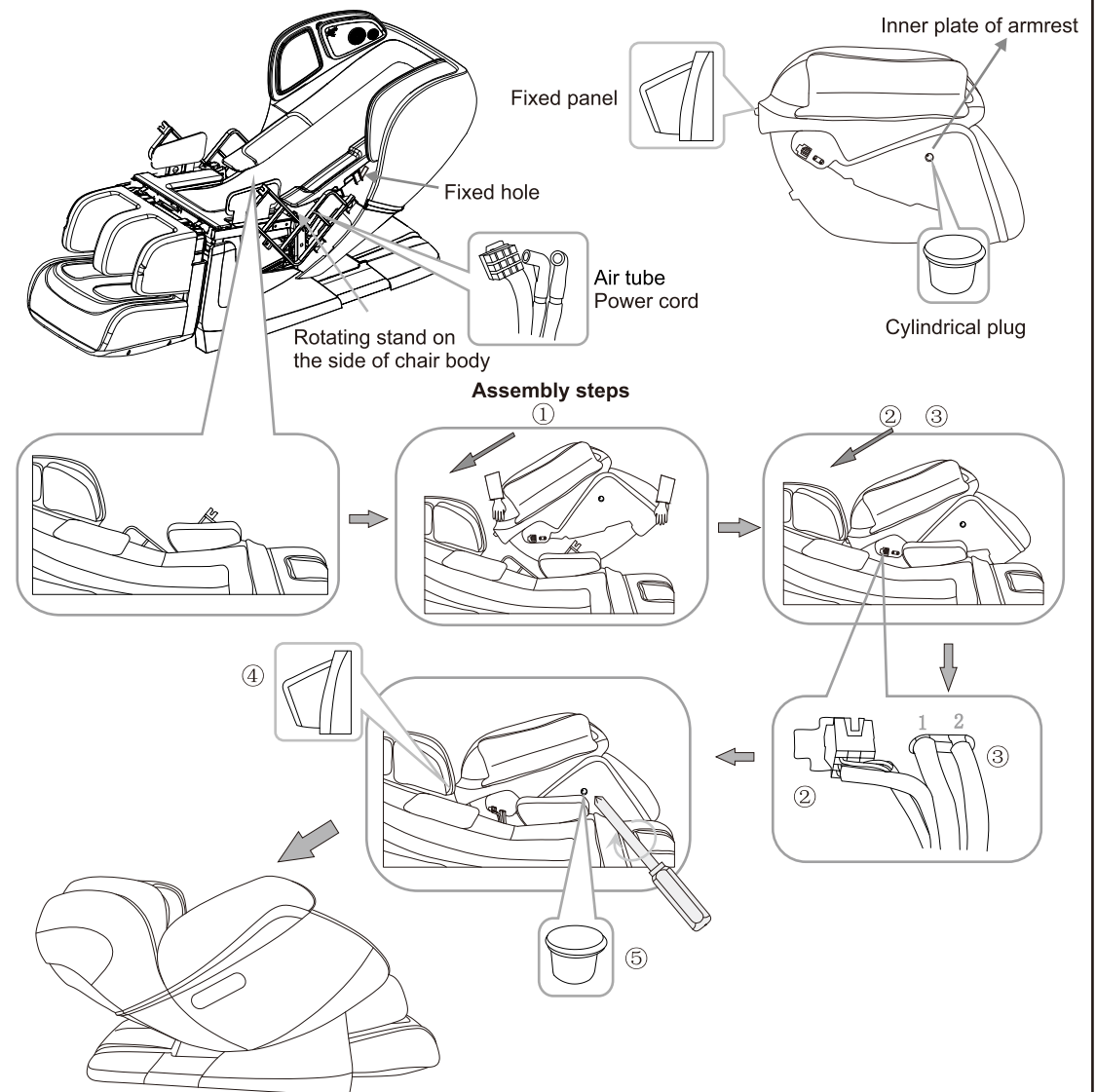

Installation (5)

Step 4. Installation of remote control and remote control pocket

- ① Make the remote control pocket with Velcro insert the upper of arm airbag which inner right armrest, connect the two parts by Velcro.
- ② Put the remote control in remote control pocket.
- ③ Put the hand controller wire plug through the fixed belt on the right side of the seat.
- ④ Align the dent part of remote control wire plug with the convex point of the socket which on right part of seat, connect the remote control plug and socket, make sure it is plugged in tightly, then tighten the nut.

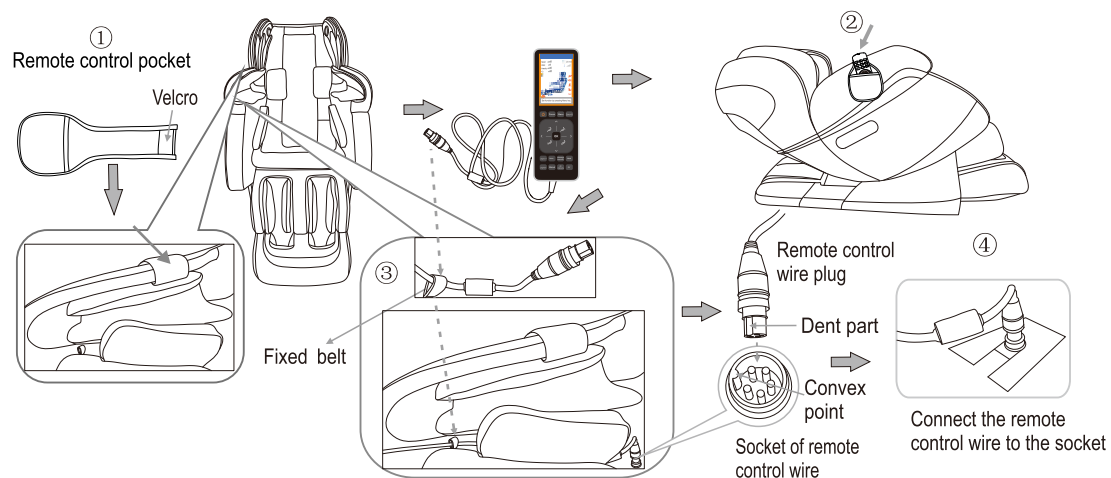

Step 5. Install the back cushion, shoulder cushion, pillow and controller bag.

Put the back seat cushion, shoulder cushion, head pad onto the backrest and connect the two parts with zipper and velcro.

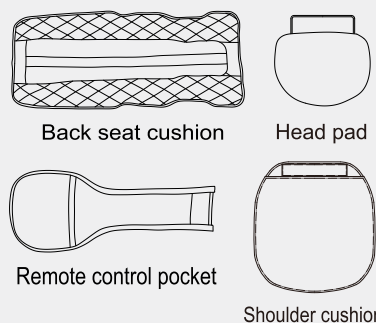

★ **Warm tips**

In order to get exact correct body test data for comfortable massage effect, when you sit on the chair, please make the bottom rim of the head pad flush with your ears before zippering the said two parts.

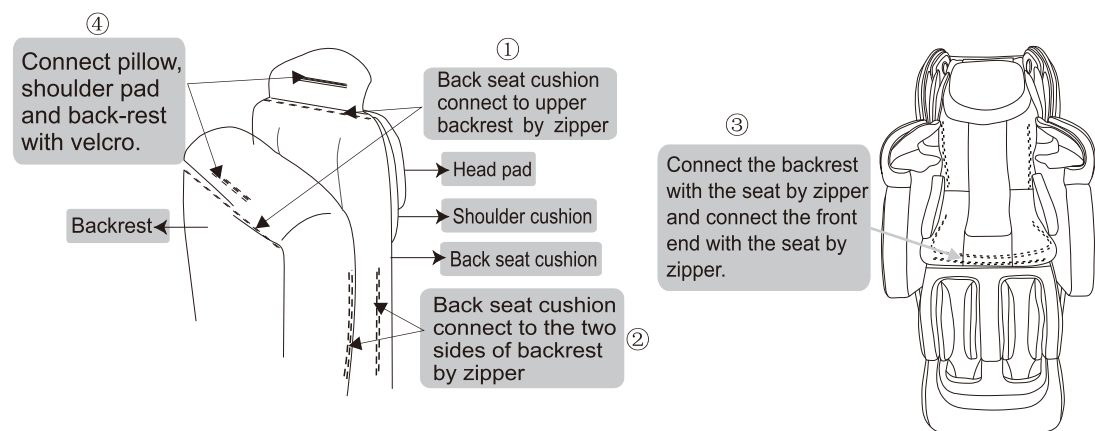

Installation (6)

Step 6. Restore the chair.

- ① Plug the cable line in the hole a on the power box as shown in the right picture.
- ② Insert the plug of cable line into the socket.
- ③ Turn on the switch behind the power box. (Switch on/off "O/I", press I down to turn it on.)
- ④ Switch off, chair resets to upright state.

Make sure the switch is off before you insert the plug of cable line into the socket.

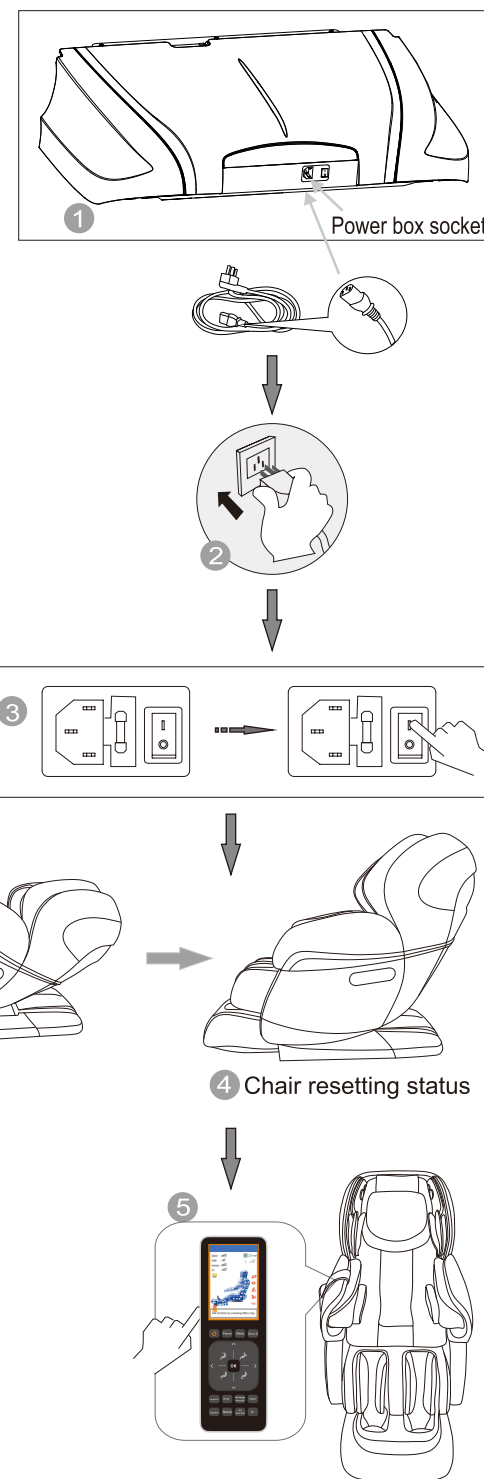

Environment



Caution



Don't use the chair in wet places like near swimming pool, bath room to avoid leakage or electric shock.



Don't use under sunlight or near stove or other heating place to avoid upholstery deteriorated.



Please use chair in flat place to avoid chair falling or noise or other unexpected trouble.

● Check places in front

Check the areas when back and leg extending, make sure no people, pets or other things around.

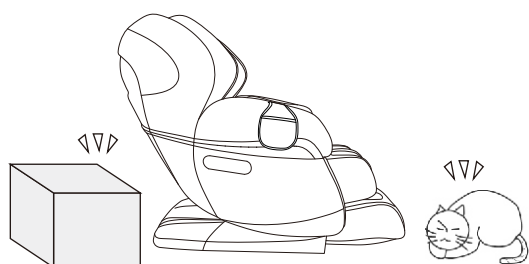

● Check power cable, plug

- (1) Clean the dust on plug on time. (using dry cloth).
- (2) No damage, re-do, bend, stretch, tie or press with heavy thing (especially can't be pressed by the chair) on power cable.

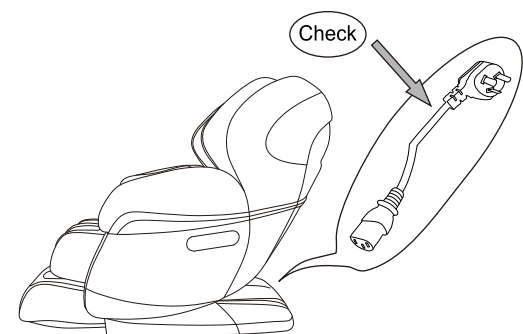

Check environment

● Space size for using the chair

- At least 10cm from wall.

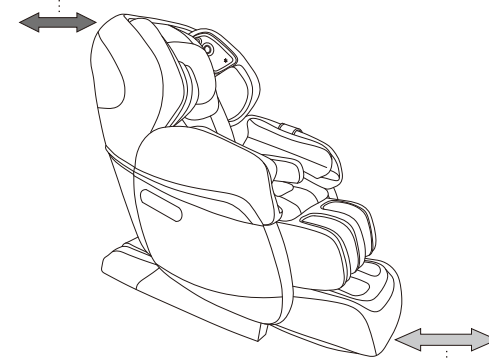

- At least 50cm in front of the leg.

● Check surroundings

When the backrest or legrest reclines or extends, please pay attention to:

- (1) Check any person or things in every direction.
- (2) Check the space size.

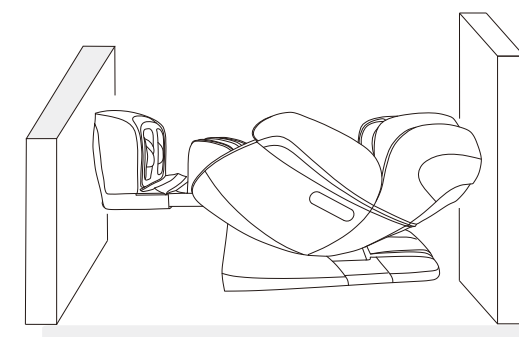
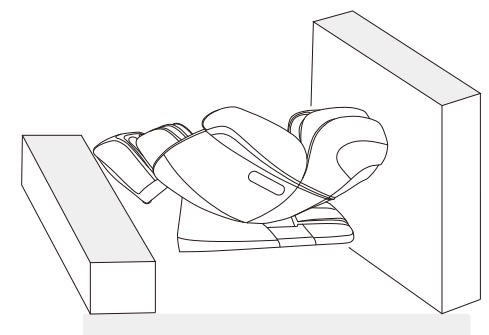

How to move massage chair



Caution

- ✦ Don't move chair when it's working in case of accidents or damage

How to move

- ✦ Bind the cables and put them in the seat to avoid damage when moving.
- ✦ If you plump the chair, it may damage the inner parts of the chair.
- ✦ Don't use the castor if the floor is wooden or other easy damaged material. It will need 2 or more persons to lift the chair.
- ✦ Make sure the power is off and the plug doesn't touch the floor (It's better to let the chair in standing status to avoid the back crashing the floor)



Normally

- 1 Press down the head part to make the gravity fall on the back castors. Then push the chair to desired destination steadily and set it down slowly.

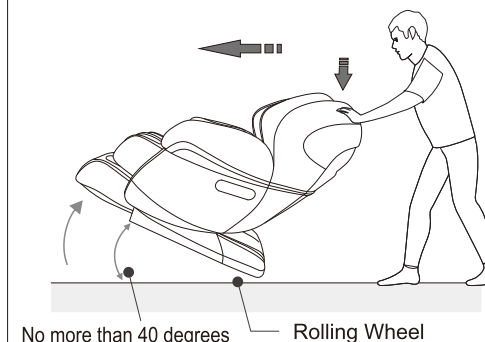

⚠ Please hold the footrest to move the chair as shown in the picture in case any scratches on the leatherette

During massage chair backrest lie down process, can't move the armrest.

Adjustment before massage

● Before adjustment

- ✦ Make sure the massage machine rollers stop in the upper of backrest, then sit on the chair slowly.

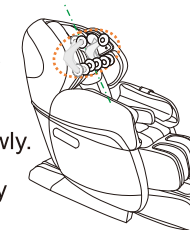

- ✦ To avoid injure caused by wrong position of the massage head.

- ✦ When doing Acupuncture Point Detecting, if the massage head can not find the shoulder position, it will default to the middle part.

Right position: Your back cling to the chair back, the head clings to the pillow.



The remote control will beep once the body scan starts working. When you hear that beep sound, you can press the up/down key on the control to manually adjust the shoulder position.

- ✦ Avoid a wrong detection of your shoulder position which will influence the massage comfort.

● Kind suggestion

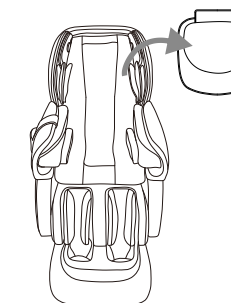

- If you feel the massage isn't strong enough, you can remove the pillow and shoulder cushion.

- Because the chair is heavy, it may ruin your floor in long time setting. Please put a blanket or other soft things to protect your floor.

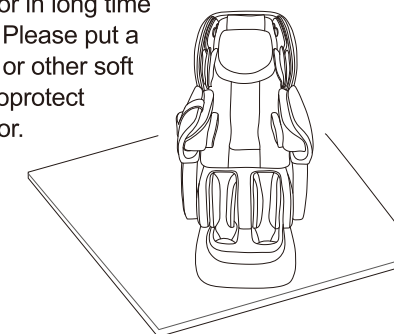

Manual control

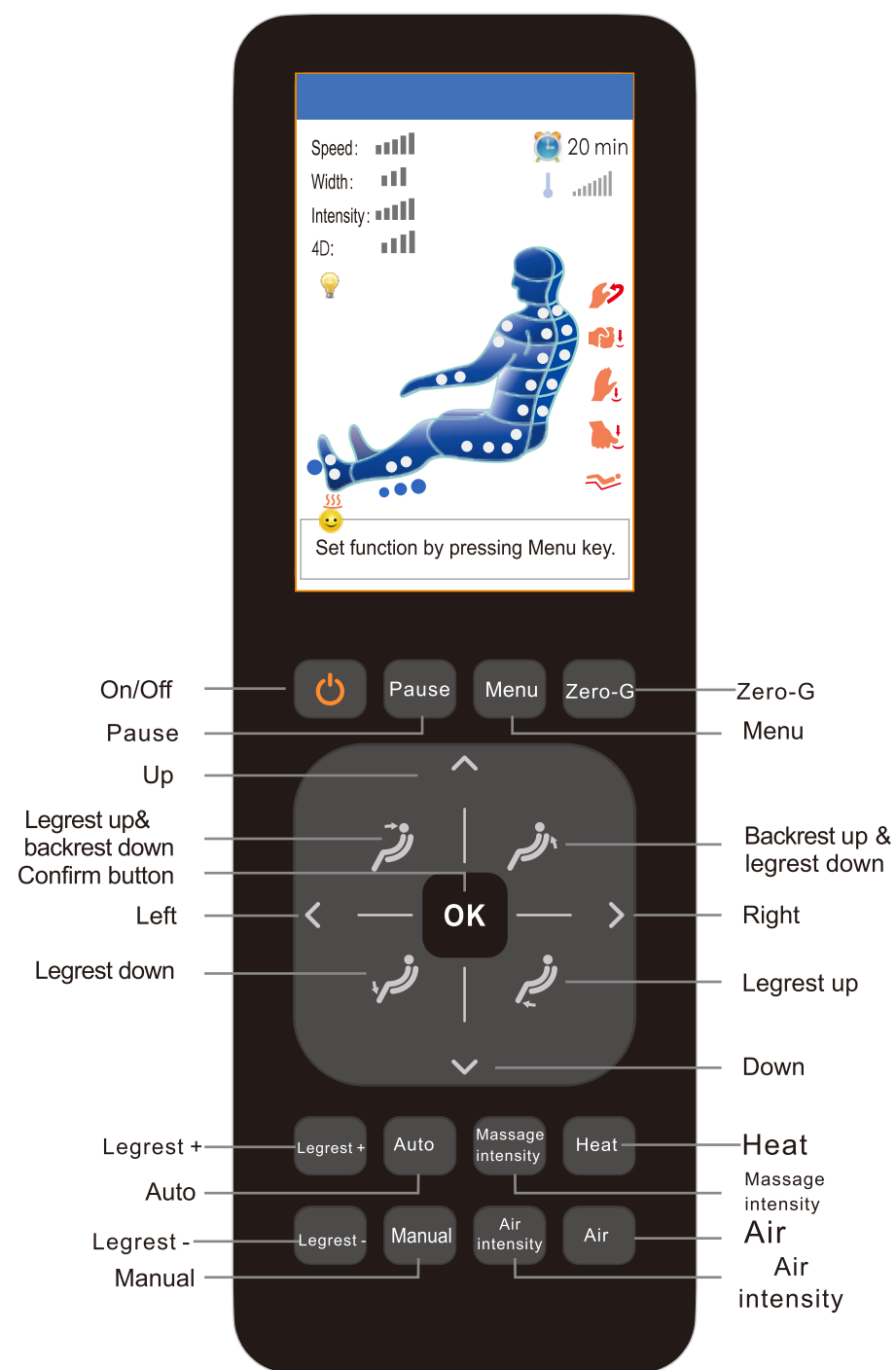

1. In standby mode, press ON/OFF key, the massage chair go into the ON status, then press Menu key or other key to choose any auto massage program, the massage machine will detect shoulder height and start to massage. In ON status, press the ON/OFF key, the massage chair will turn off and return to original status, the legrest goes down to the lowest position, the backrest raise up to the top, the controller turn off in 3-5 seconds.

2. When power on, press this button to stop all the functions. All the buttons become invalid at this moment; Press on/off key to re-activate the massage.

3. Press this button in Main interface to switch to menu interface, user can set different function for massage chair. Press it in Menu interface to return to main interface.

4. In ON status, press this key once to reach zero-gravity level one state; press this key again to reach zero-gravity level two state; press the key for a third time to reach sleeping mode. Press it for a fourth time, massage chair resets to upright position. It works like this in circles.

5. Keep pressing this button, backrest go down, legrest go up, release this button, backrest and legrest stop moving. When adjusting sitting position, it shows seat position adjusting... in controller screen.

6. Keep pressing this button, backrest goes up, legrest goes down, release it, backrest and legrest stop moving. Controller screen will show position adjusting... when adjusting the position of massage chair.

7. Keep pressing this button, legrest goes down, release it, legrest stop moving. Controller screen will show position adjusting... when adjusting the position of massage chair.

8. Keep pressing this button, legrest goes up, release it, legrest stop moving. Controller screen will show position adjusting... when adjusting the position of massage chair.

9. In ON status of menu mode, press this button for confirm to choose menu item or pop up at the next menu.

10. There are four direction buttons: Up, Down, Left and Right. In the menu interface, it is used as navigation key: press Up and Down to quickly browse the menu, and press Left and Right key to go to previous and next menu. In manual mode, the Up and Down key can also be used to adjust massage roller position in body scanning and fixed point massage.

11. Press this button, the legrest can extend and retracted.

12. Auto program, can adjust the air pressure with this button.

13. Press this button can control massage intensity

14. In ON state, press this key to start the massage machine heat

15. In ON status, press this key each time to change one kind of manual program, there are 5 massage methods for choice, "Kneading", "Knocking", "Tapping", "Kneading&knocking", "Shiatsu", there is relative status screen display.

16. Press this button can control the intensity of the massage air bag.

17. Press this button can turn on/off the air pressure massage, when it was on, the air pressure massage was activated.

ON/OFF

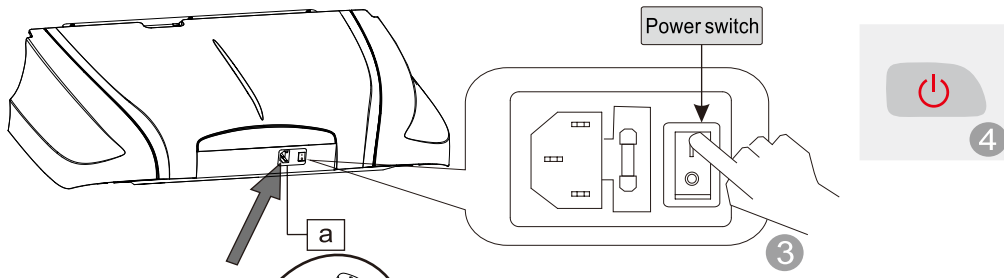

Step1. Power on

- Put one end plug of power line to "a" hole.
- Put power plug to socket.
- Turn on the power switch on the power box, massage chair powers on.
- Press "ON/OFF" button on the remote which will beep once. It will then enter the display interface .

Step2. Massage

- Operate according to controller operation instructions. As for the massage method's details, please refer to remote control's Usage page.
- When the massage ends, massage machine will return to the default position, meanwhile "Shutting down" will be displayed on the controller.



Remote control

Step3. Turn off the power

- When the chair is On, press On/Off button to turn off the massage chair and it will restore automatically.
- Turn off the power switch on the bottom of the back of chair after the rollers reach storage position.
- Unplug the power plug from the socket.



Warning

- Before using, pull up the pillow, back cushion etc. to check if the PU material is broken, if there is damage, please stop using, unplug the chair, and ask for repairment.
- Only plug to proper socket.



Attention

- Before sitting down, make sure there is no things pinched between armrest, legrest , backrest and seat of the chair.
- Foot-rest is equipped with safety protection device, if there is any obstacle between the leg and foot, foot-rest will stop retraction automatically.
- Make sure the chair is in reset state before using.
- Do not stand on it when using the massage chair.

Function Illustration

● Legrest Up

Press this button on controller, legrest goes up. Release the button, legrest stops moving, the angle is locked in this position.

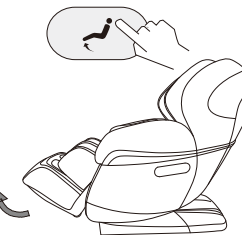

● Legrest Down

Press this button on controller, legrest goes down. Release the button, legrest stops moving, the angle is locked in this position.

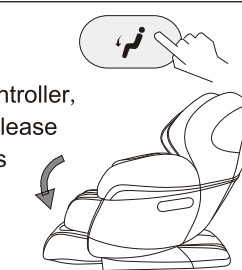

● Legrest up and backrest down

Press this button on controller, backrest goes down and legrest goes up. Release this button, backrest and legrest stops moving, the angle is locked in this position.



● Backrest up and Legrest down

Press this button on controller, backrest goes up and legrest goes down. Release this button, backrest and legrest stops moving, the angle is locked in this position.

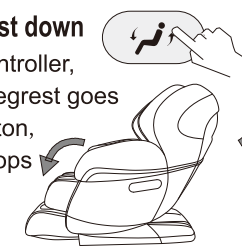

● Legrest extend and retract

Legrest can extend and retract within 22cm automatically.

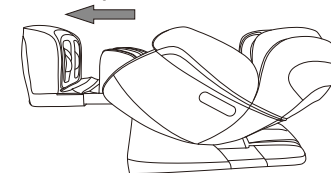

● Zero gravity

Press this button, Backrest goes down and leg-rest raises up. This puts the chair in the comfortable Zero-Gravity position. Press the button again to put the chair in the Sleeping angle. Press this key for a third time to restore the chair into its default position. Backrest raises up and leg-rest goes down.

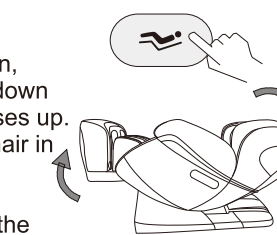

★ **Tips:** Zero-gravity is according to the NASA Space capsule relax theory, through the back ,seat,legrest three sections multi angle changeable, making the legrest up and seat down can make the angle 128 (+/-7)degrees between Body and legrest. let the heart and knee at the same level, reducing the blood circulation pressure to the lowest, but all the body pressure will put on the buttocks, And because of the ZERO GRAVITY position design, increase the forced area from the body and massage chair, so all the forces can be dispersed to the massage chair, reducing heart and spine pressure ,realizing the best Zero gravity massage experience. creating a completely relax, mature and comfortable massage posture.

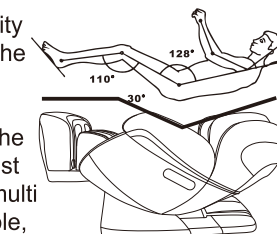

● New Curve rail, Combination of back and buttocks massage.

Massage chair adopts 4D curved rail technology, combining with 4D massage mechanism patent, realizing multi-angle integrated massage for back and buttocks. It has broken through traditional L shape rail's function which can't realize lying flat and stretching, and achieve best massage effect.

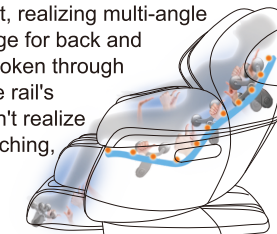

- Please make sure there is no people, no pets or any stuff around the backrest to avoid unexpected hurt or property loss.
- When adjusting the backrest, be careful of the gap between the backrest and armrest.
- When the legrest is moving, please do not stand on or leave from the seat, do not stop the legrest from moving in case of causing damage to the chair.
- Please refer to control instruction for more details.

Function Illustration

● **Arm massage**

Massage chair use space capsule type armrest, with built-in pulse air pressure massage function. Put the arms between armrest's air bags. After filling air, achieve kneading massage on the arms and hands. The arms could get comfortable massage in any angle of the chair.

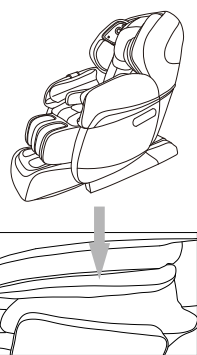
● **Shoulder massage**

Multi-layer exposed airbags are located on both shoulders to assist with stretch function. The 4D massage rollers push forward your body, while the airbags grip your shoulders to provide the ultimate full body stretch.

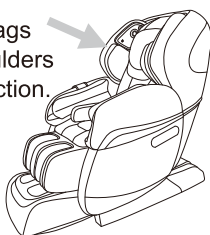
● **Leg rubbing function**

The innovative leg rubbing technology provides kneading and rubbing massage on the leg muscles, which can effectively relieve the leg aches and restore the leg rejuvenation.

● **Warm foot therapy**

Innovatively developed two-way rotary foot kneading technique, realizing the sole function of kneading foot, combining with foot heating, it can perform best foot massage experience, good for health.

● **Music therapy**

There are multiple speakers surrounding the headrest. The blue-tooth wireless music player can integrate music into the massage techniques with synchronic therapy, which allow the rollers to massage you to the beats of your music. Relaxing to your own tunes will improve your blood and ease fatigue.

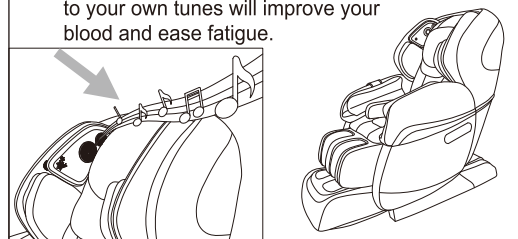
● **Voice Operation**

Using speech recognition, you need to first say the command entry: turn on speech recognition mode, then it can identify the rest of the order entry. You can hear the corresponding speaker voice feedback after massage chair recognize the command entry successfully. The corresponding relationship is as follows:

Recognition entry	Feedback voice
Turn on speech recognition mode	Speech recognition has been opened
Chinese Massage	Chinese Massage has been opened for you
Pain relief	Pain relief has been opened for you
Body stretch	Body stretch has been opened For you
Experience	Experience has been opened for you
Relaxation	Relaxation has been opened for you
Zero Gravity Start	Zero Gravity Start
Voice Off	Voice recognition mode is off
Massage chair shutdown	Massage chair is powering off

Attention:

1. Turn on speech recognition mode, if you say "Voice Off" and "Massage chair shutdown", the massage chair will shut down by default; if you want to restart, say "Turn on speech recognition mode" again.
2. After voice command is recognized, the speaker makes speech feedback after 1 second, now to say the next command entry, the result will be better.
3. After turning on speech recognition mode, the default massage chair identifying time is 3 minutes. After 3 minutes, it will exit identification mode. If you want to restart, say "Turn on speech recognition mode" again.
4. Please use standard language, speak gently.

Restoration of massage chair

- 1 Make sure there is no people or pet or anything within the range of backrest and legrest.

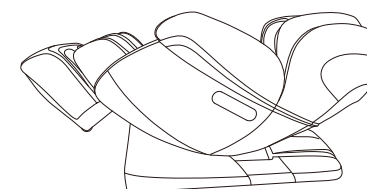

- 2 Make backrest and legrest restore to the normal position by controller.(or press ON/Off key to make backrest and legrest restore to the normal position)

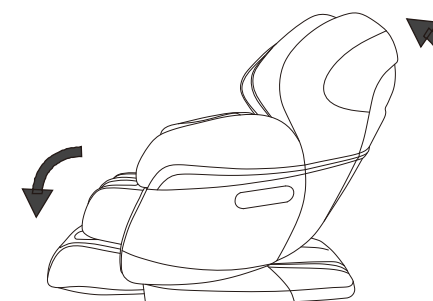
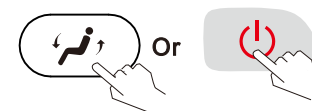

- 3 After chair returns to the upright position, store the controller in the pocket on the right armrest.



- 5 Switch off the power.

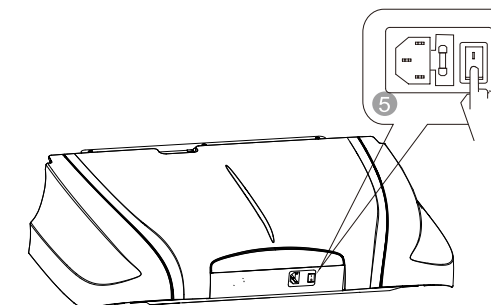

- 6 Unplug the electricity from the socket. (Attention: hold the right plug position)

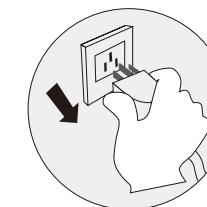

- 7 Clean the chair if necessary.

Attention!

- After using, press ON/OFF to end all the massage method and wait for restoration.
- Make sure to cut the electricity to avoid any unexpected hurt to children or pets.
- After using, turn off the power, unplug the electricity. Avoid moisture, dirt and aging of insulation in case of causing damage.

Synthetic leather

● **General cleaning**

Clean with tidy, soft and dry cloth slightly.



Do not use the thinner, gasoline, alcohol or other chemical materials.



● **If leather is dirty**

- ① Dip soft cloth into 3-5% neutral detergent solution, squeeze it then clean the stain on the surface gently.
- ② Wash cloth, squeeze it and wipe with detergent.



- ③ Clean it softly with dry cloth.
- ④ Allow to dry (air blower is prohibited)

Plastic parts

- ① Dip cloth into neutral detergent, squeeze it and clean.
- ② Wipe with water-dipped but squeezed cloth.
- ③ Allow to dry.



Clean the controller

- ① Wipe with soft cloth after squeezing.
- ② Allow to dry.



Do not use the thinner, gasoline, alcohol or other chemical materials.



Remote control

Cloth material

- ① Dip cloth into weak neutral detergent, squeeze it and clean the material surface.

- Do not use the thinner, gasoline, alcohol or other chemical materials.

- ② Brush the dirty parts with weak neutral detergent. (avoid excessive brushing)

※ Excessive cleaning may cause damage to cloth material.

- ③ Wipe with water-dipped but squeezed cloth.

- ④ Allow to dry.



About cleaning

- Before cleaning, unplug the electricity, don't touch plug with wet hands.
- Make sure hands are dry when plugging to the socket.
- If failed to follow the mentioned instruction, user may get electric shock or burned.

FAQ and Troubleshooting

Trouble	Possible reason	Troubleshooting
The massage chair can't work after power is on.	Check if the control is on or not.	Open control switch
	Not choose massage function	Choose massage function
	Check whether the plug and socket in poor contact.	Make sure plug and socket are connected.
	Wire or plug has damaged.	Please ask manufacturer or appointed or authorized maintenance man for checking and replacement.
	The fuse burned out.	Replace fuse of same specification.
There is beep sound inside the massager while working.	It is sound of air pump, motor and mechanical parts.	Normal sound, no need to pay attention to it.
Different height of the left roller and right roller.	Massage rollers work on shifts.	Normal, no need to pay attention to it.
Sound suddenly becomes much louder while working.	Check if it is due to long time working.	Turn off the power to have the massager rest for over half an hour before next turn working.
	Inner parts fretted away due to long time work. It's normal	Please ask appointed or authorized maintenance man for checking and repairing.
Massage function suddenly stops while working.	Suddenly power-down	Connect the electricity power again
	Setting time is up.	Turn off the power to have the massager rest for over half an hour before next turn working.
Neither the backrest nor the legrest can be lay down.	Check if there are any obstacles; the chair overloads; for the sake of safety, sometimes the massage machine may automatically stop working.	Remove the obstacles; turn off the power to have the massager rest for over half an hour before next turn working.
The chair can't return to its original position.	Excessive operation; setting time is up.	Please ask manufacturer or appointed or authorized maintenance man for checking and replacement.
Electric wire or plug give out heat	It may work overload	Turn off the power to have the massager rest for over half an hour before next round working.
	Other abnormal case	Stop using, and ask appointed maintenance man for help.



Note: If the troubles are not caused by above reasons, please turn off the power switch and cut off the power, then contact the manufacturer or service agent to repair your chair.

Technical data

Name	Massage Chair	Power	280W
Model	OSAKL Pro-paragon	NW/GW	Main body: 100/121kg Armrest : 17.5/21kg Legrest & footrest: 31.5/35.5kg
Input voltage	<input type="checkbox"/> AC120V, 60Hz <input type="checkbox"/> AC220V, 50/60Hz <input type="checkbox"/> AC240V, 50Hz	Packing size	Main body: 1520×795×955 mm Armrest: 950×400×720 mm Legrest & footrest: 585×570×615 mm (L×W×H)
Safety design	Class I		