

Imperial Massage Chair

USER MANUAL

Thank you for your purchase of this product. Before using, please read this USER MANUAL carefully, and pay special attention to the safety precautions to ensure proper operation and use.

Please keep this USER MANUAL for further reference.

CONTENTS

SAFETY PRECAUTIONS	1
NAME AND FUNCTION OF EACH COMPONENT	3
External structure	3
Internal structure	3
Controller	4
Instruction of Controller	5
Instruction of Display screen menu	6
FUNCTIONS AND FEATURES	13
APP DOWNLOAD AND INSTALLATION	14
USB Charger and Memory System	16-17
PREPARATION BEFORE USING	18
Installation Method	18
Move method	21
Turn on power supply	21
Installation position	22
Floor protection	23
Surrounding environment	23
Massage chair commissioning	24
Before sitting in the chair	24
Legrest Extend and Retract	25
After using	25
PRODUCT STORAGE AND MAINTENANCE	26
TROUBLE SHOOTING	27
TECHNICAL SPECIFICATIONS	28

▶ TECHNICAL SPECIFICATIONS

Name: Imperial Massage Chair

Model: Infinity Imperial

Rated voltage: 110-120V~

Rated frequency: 50/60 Hz





Rated power: 145W

Safety design: Class I



▶ SAFETY PRECAUTIONS

Safety Precautions

- ▶ Before using, please read these SAFETY PRECAUTIONS carefully to ensure proper operation.
- ▶ The following SAFETY PRECAUTIONS should be read and understood by any user of this massage chair.
- ▶ To clearly indicate the degrees of danger and damage, the classes of accidents caused by incorrect use are classified into WARNING and CAUTION, instructions marked as followings should be strictly followed:



 WARNING	Improper operation may cause injury to users.
 CAUTION	Improper operation may cause users injury or product damage.
	Forbidden. Specific instruction will be indicated in the diagram drawings.(E.g, the left drawings means disassembly is not allowed.)
	Compulsory Specific instruction will be indicated in the diagram drawings.(e.g, the left drawings means to disconnect the power plug)

WARNING

 COMPULSARY	<p>We recommend that those with any of the following conditions should consult a doctor before using.</p> <ol style="list-style-type: none"> 1. Those who are using electronic medical instrument imbedded in the body, such as cardiac pacemaker etc. 2. Those that are being treated by doctors for specific medical reasons should check with doctor for approval in using the massage chair. 3. Those who are malignant tumor patients, heart disease patients, acute patients. 4. Women who are pregnant. 5. Those with osteoporosis or have spinal injuries or problems. 6. Those with skin disease or those whose skin has injury.
 PROHIBITED	<p>Do not allow the mentally disabled to use the chair alone. (It is OK under supervision)</p> <p>Do not allow children play on massage chair.</p> <p>Do not allow more than one person to use this massage chair at a time.</p> <p>If the power cord or power plug becomes damaged in any way you must unplug the chair immediately and consult an authorized service engineer for repair or replacement.</p> <p>Do not damage, modify, excessively bend, pull hard, twist or knot power cord.</p> <p>Juveniles are not allowed to use this product.</p>
 NO DISASSEMBLY	<p>Anyone else, except maintenance personnel specified by our company, should not disassemble, maintain, or remodel this massage chair.</p>

SAFETY PRECAUTIONS

CAUTION

 COMPULSARY	<ul style="list-style-type: none"> ◆ Please do not continuously use the massage chair over 20 minutes, when new to the chair. ◆ Please put the massage chair on flat surface for use. ◆ When adjusting the legrest or backrest, please do not exert excessive force on it; in addition, keep children and pets away. ◆ When removing power plug, please hold the plug, do not pull power cord. ◆ Please do not use a power supply that is beyond the specified electric voltage. ◆ Before using, please uncover the back cushion to check whether backrest or fabric is damaged; if damaged, please stop using this massage chair immediately, and contact manufacturer for repair immediately. ◆ Please do not operate the controller with damp hands, and do not put heavy objects on controller. ◆ Anyone over 260 lbs are too heavy for this chair. ◆ Please do not use other therapeutic equipment together with this massage chair. ◆ During use, if you feel uncomfortable, please stop use immediately and consult your doctor. ◆ This massage chair is designed and intended for non commercial household use only, do not use the massage chair for medical treatment. ◆ The massage chair is equipped with heating function, so people who are insensitive to heat must use it carefully. ◆ Always switch off power and remove the plug from the socket immediately after use and before cleaning. ◆ To avoid causing discomfort, do not use the massage chair immediately after meals.
 PROHIBITED	<ul style="list-style-type: none"> ◆ In case that any surface ,like back cushion or cloth is broken, please stop using the chair at once, and contact the manufacturer or repair tech for help. ◆ Do not fall asleep on massage chair when the massage chair is working. ◆ Do not use the massage chair when you are intoxicated or ill. ◆ If the upholstery becomes dirty, please use only known good quality leather cleaner, do not use chemical cleaners, petrol or detergents etc, and do not spray any pesticide on it. ◆ Do not sit on backrest, legrest, or armrest to avoid accidental injury or damage to chair. ◆ Please do not smoke while using the massage chair.
 REMOVE PLUG	<ul style="list-style-type: none"> ◆ Before maintenance, please pull out power plug. In addition, please do not insert or unplug the power plug with damp hands, to avoid electric shock. ◆ When the massage chair is not in use, please switch off power and remove the plug from socket.

TROUBLE SHOOTING

No.	Problem	Possible Cause	Solution
1	Sounds coming from massage mechanism	It is normal for sound to be made by the motors, or the massage rollers rubbing on the backrest area.	It is normal and no need for treatment.
2	The chair can not be started up.	The power supply plug is detached.	Insert the power supply plug into the socket again.
		The power supply switch is not turned on.	Turn on the switch
		The fuse of massage chair blew out.	Replace with a new fuse.
3	No sound from the speakers	The volume is turned to lowest.	Turn the volume up
4	Backrest or legrest can not ascend or descend	Over pressure is put on backrest or legrest.	Reduce the pressure on backrest or legrest.
5	The airbag installed at seat cushion or legrest not working.	Check whether there is air tube blockage	Clear the air tube

If chair is still operating abnormally after above measures have been taken to the massage chair, please contact manufacturer for repair and maintenance.

Note: Do not dismantle the product by yourself. Infinity Massage Chairs shall shoulder no responsibility to the damage of the product or the injury of people caused by improper use! Thanks your cooperation.

▶ PRODUCT STORAGE AND MAINTENANCE

Maintenance

- ▶ Wipe down the chair with a mild cleaner and a damp cloth.
Use dry cloth to wipe the controller and power supply box.
- ▶ Use a piece of cloth that has been dipped with neutral detergent to wipe the back cushion and pillow, then use a piece of wet cloth to wipe them, and finally put them to a well-ventilated place for natural drying.

⚠ Caution

- ▶ Make sure to pull out the power supply plug firstly before maintenance. Do not use wet hands to pull out the plug to avoid electric shock. When clean the back cover, please be cautious of detergent entering into the power supply box!
- ▶ Do not iron the upholstery.

Storage method

- ▶ Wipe off dust and dirt from the product after use, if the product is not to be used for a long period of time, please cover the product with a dust cover (self provided).

⚠ Caution

- ▶ Do not store the product under direct sunlight or in places of high temperature. This may cause the color of the upholstery to fade.

Reminder

During daily use, please check whether the following symptoms exist:

- ▶ Any unusual smells.
- ▶ Power issues.
- ▶ The power supply cord is hot.
- ▶ Other abnormal symptom

⚠ Caution

- ▶ Please stop using the massage chair to avoid breakdowns and accidents occurring if any above symptom exists.
- ▶ Turn off the power supply switch and pull out the power supply plug, and then contact the manufacturer or technician for repair and maintenance.
- ▶ Except all the normal operation and maintenance mentioned above, any other repair and maintenance can only be operated by our authorized dealer or service agent.

▶ NAME AND FUNCTION OF EACH COMPONENT

External structure

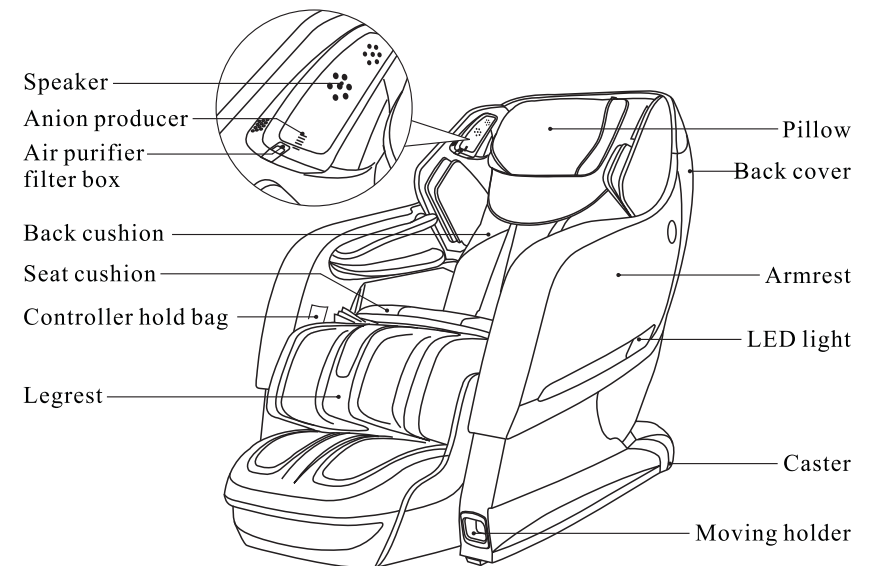

Internal structure

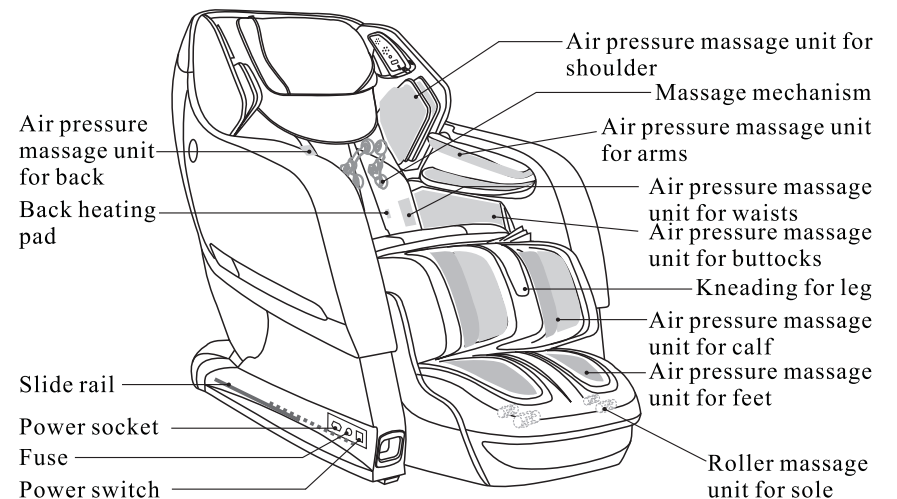

▶ NAME AND FUNCTION OF EACH COMPONENT

Controller

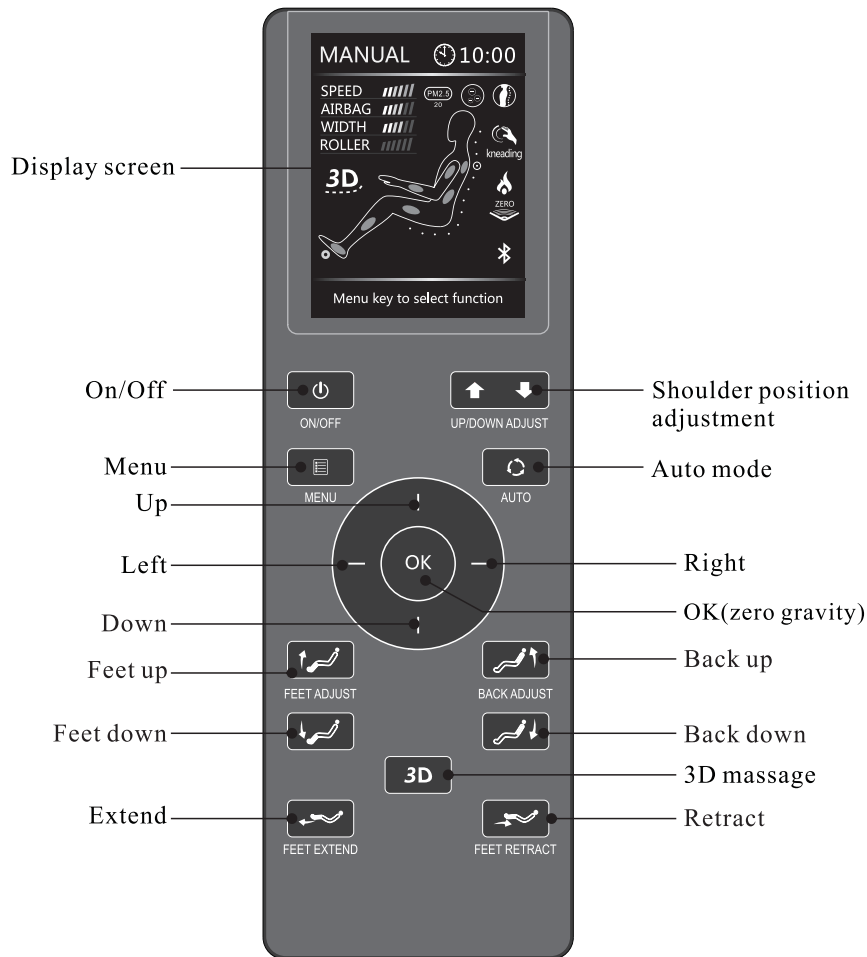

▶ PREPARATION BEFORE USING

Legrest Extend and Retract

- ▶ To adjust legrest to match your leg, press or to adjust the relative position of leg and legrest manually when legrest is not moving in order to get the best massage.

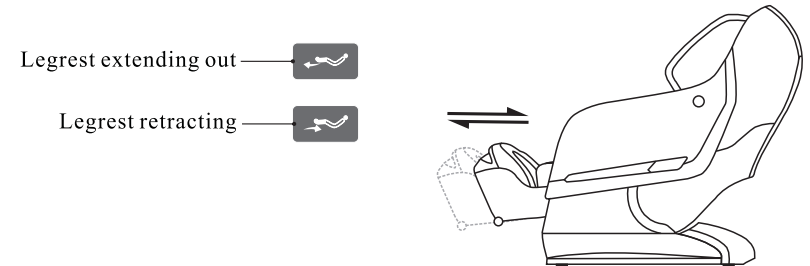

- ▶ Legrest can be extended or retracted automatically or manually according to different position and height, because of sensor inside

⚠ WARNING

- ▶ Only use chair as intended. Sit in chair in normal position.
- ▶ Before adjusting the angle between calf and backrest parts you need to make sure no obstacles are around.
- ▶ Do not insert leg, foot or other goods into chair's gaps when leg parts extend or reset.
- ▶ Wait for chair to reset completely before exiting chair.

After using

- ▶ Please power off the chair and unplug the chair power cable from the power supply socket after using the massage chair.
- ▶ Put the controller inside of the pocket.
- ▶ Please power off the chair and unplug the chair from the power supply socket when the chair is not in use, to avoid children starting the chair accidentally.
- ▶ Please cover the chair if it is not in use for a long time.

► PREPARATION BEFORE USING

Massage chair initial setup

- Before setting up, please make sure there is enough space around the chair. Then use the controller to recline down the chair backrest to the limit position, raise up the legrest to the highest position and stretch out to the limit length. Make sure the chair will not contact anything.
- Test all functions work normally, then power off the chair and return it back to original position.

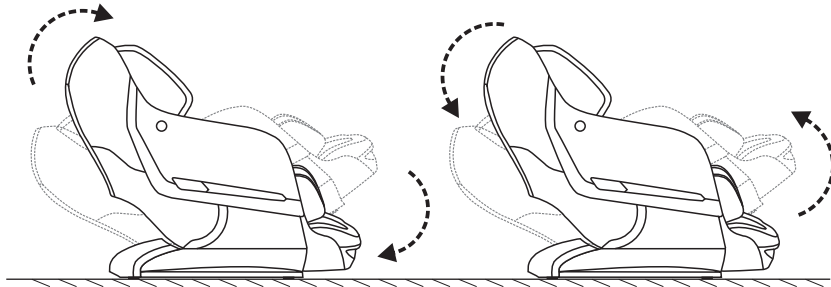

Before sitting in the chair









- Make sure the legrest is installed correctly.
- Make sure the chair is in original position, if any part is not in initial position, please power on/off again to make the whole chair go back to original position.

Caution

- If the legrest is moving, do not climb onto the chair.
- Do not put any heavy load on the legrest when it is moving.

► NAME AND FUNCTION OF EACH COMPONENT

Controller Instructions

-  **On/Off**
 - When power is on, click this button, display screen will light, then click up/down button to choose the auto, manual, 3D massage, ionizer, airbag, heat and setting menu.
 - Click this button again to turn off all functions. The default working time is 20 minutes
-  **Menu**
 - Click this button to choose auto, manual, 3D massage, ionizer, airbag, heat and setting menu.
-  **Shoulder position adjustment**(mechanism up and down adjustment)
 - Under manual point mode, press the up or down buttons to place massage unit on a specific area.
 - Under auto mode body sensor, press these buttons to adjust shoulder position after body scan.
-  **Auto programs**
 - When massage chair is working, press auto button to enter auto program menu, you can choose sports refresh, extension, rest&sleep, working relief, neck&shoulder or waist&spine. (3D massage excluded). (See the LCD menu for detail)
-  **Direction adjustment**
 - Under menu and auto mode, press the button to adjust direction. When program is determined, press the middle OK button to confirm it and enjoy the chosen massage.
 - During the massage, press OK button to switch to zero gravity, Press up or down button to adjust mechanism speed. Press left or right button to adjust airbag force.
-  **3D massage**
 - Under manual mode, press 3D button to adjust the 3D force.
-  **Feet up**
 - Press this button, the legrest will move to the top position. Press again, it will move to the bottom.
-  **Feet down**
 - Press this button, the legrest will move down to the lowest position, releasing this button, it will stop.

▶ NAME AND FUNCTION OF EACH COMPONENT



Back up

▶ Press this button, the backrest will be moved up to the original position, release this button, it will stop.



Back down

▶ Press this button, the Backrest will be moved down to the lowest position, release this button, it will stop.



Legrest extend

▶ Press this button, the legrest will be extended to the longest position, releasing this button, it will stop.



Legrest retract

▶ Press this button, the legrest will be retracted to the original position, releasing this button, it will stop.



WARNING

▶ Press power button after use to put the chair in reset state. Please press any buttons in the remote controller to stop reset. Press the power button again to continue the operation or enter into massage state.

Display screen menu

▶ Auto mode

Press power button this will turn the LCD on. Press auto to enter auto program menu. You can choose sports refresh, extension, rest&sleep, working relief, neck&shoulder or waist&spine according to your desire. (See the menu picture below)

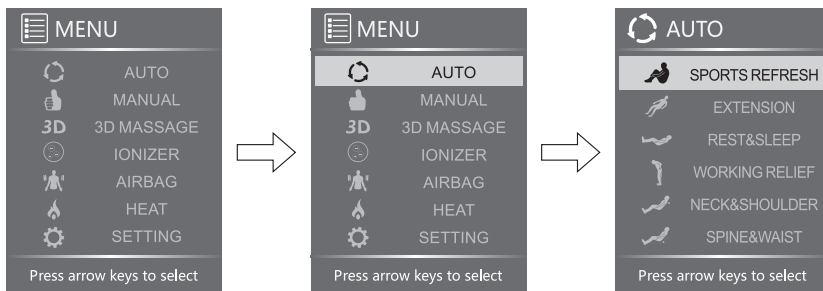

Sports refresh: This is designed for the muscles after sports activities and exercise. It can ease and relax muscles after intense exercise, promoting the circulation system to improve muscle recovery after exercise.

Extension: This massage comes from Thai massage. the strong kneading and stretch of the body can effectively stretch legs, waist and other parts, and it is the best choice to relax tired muscles and increase physical vigor.

▶ PREPARATION BEFORE USING

Floor protection

▶ Please put carpet or other pad under the massage chair, in order to avoid any scuffing or marking on the floor.

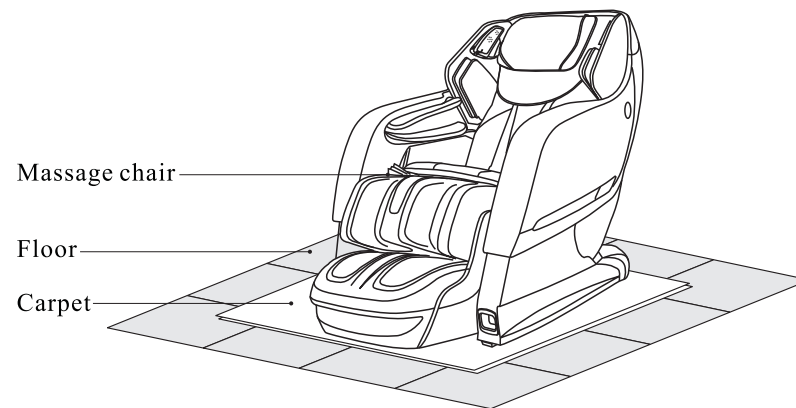

Surrounding environment



Keep the massage chair away from damp places (for example: bathroom).



Keep the massage chair away from high temperature sources (for example: stove) to avoid fire or damage to leather material.

PREPARATION BEFORE USING

Installation position

Safety distance for the periphery of massage chair.

- ▶ Please make sure there is adequate space for installation this product:
Back: minimum 4" from the wall or any other objects.
Front: minimum 24" from any other objects.

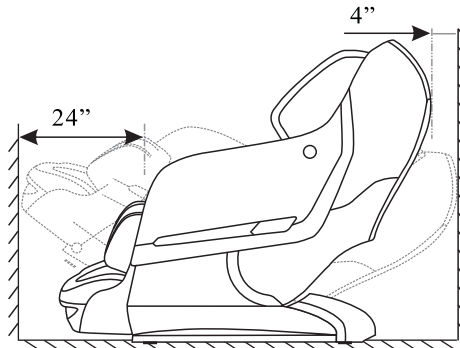

- ▶ The distance between the power socket and the power switch must be within 5 feet.

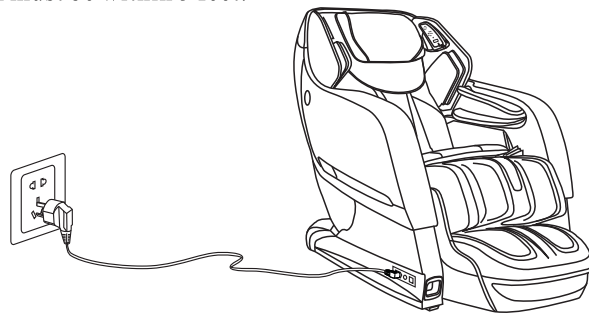

Caution

- ▶ Make sure the distance between the power socket and the power switch is less than 5 feet to avoid damage to the power cables when the chair reclines up and down.
- ▶ Before using, please make sure cables are clear of chair.
- ▶ When the whole chair makes parallel movement forward or return back to original position, please check first whether there are kids, pets or some other barriers to avoid accidents.

NAME AND FUNCTION OF EACH COMPONENT

Rest and sleep: To improve the quality of lunch break and sleep; The mild massage kneads body parts with heavy and light strength massage to relieve tired body gradually.

Working relief: Great program for people who work at a desk or travel a lot. Strong massage to ease muscles and recuperate body.

Neck and Shoulder: To relieve neck and shoulder pain symptoms 80% of the massage time will focus on the neck and shoulders. The curve design of the chair backrest makes the massage rollers completely touch the shoulder and neck, so it can effectively relieve neck and shoulder fatigue.

Waist and Spine: To relieve the pain of lumbar vertebra 80% of the massage time will focus on the lumbar vertebra and the rollers will conduct specific massage to relieve the sense of tension and insure lower back health.

Manual Programs:

Press Menu button, choose Manual and press it to enter manual programs.

Press up or down button to choose mode, part, width, speed, roller or zero.

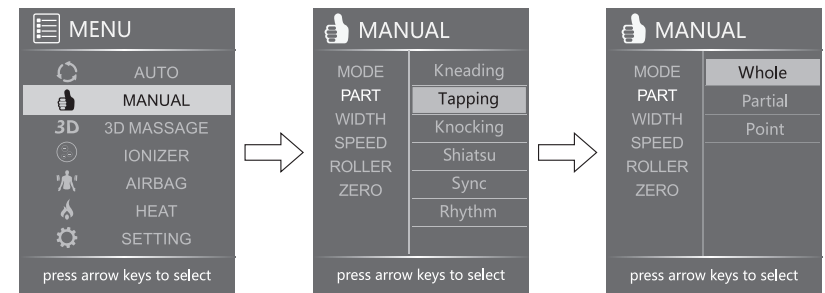

Mode: Under mode function, press right button first, then press up or down button to choose massage style of kneading, tapping, knocking, shiatsu, sync, or rhythm.

Part: Under Part function, press right button first, then press up or down button to choose whole, partial or point.

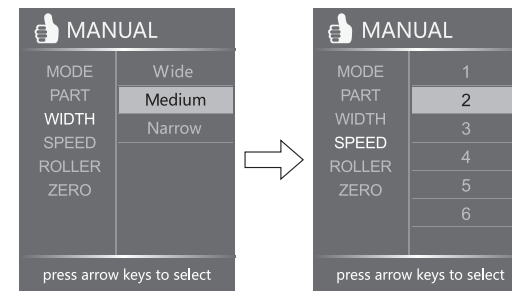

WIDTH: Under Width function, press right button first, then press up or down button to choose Wide, Medium or Narrow.

SPEED: Under SPEED function, press right button first, then press up or down button to choose speed from one to six.

▶ NAME AND FUNCTION OF EACH COMPONENT

ROLLERS: Press MENU button first, then choose ROLLER, adjust the roller speed from 1 to 3 or stop the rollers by pressing up or down button.

ZERO GRAVITY: Zero gravity creates a completely relaxing, naturally comfortable massage position: Somatological design makes back, buttocks and legs stay in a certain angle like lying in space capsule, under which the body pressure is thoroughly released and the muscles achieve a completely relaxing status.

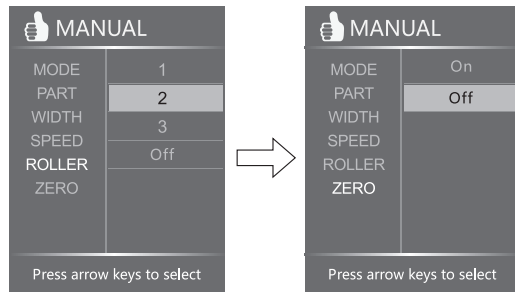

▶ 3D MESSAGE

Press MENU button first, then choose 3D, adjust the 3D MODE (Deep shiatsu, healthy breath, massage extend), massage force and part.

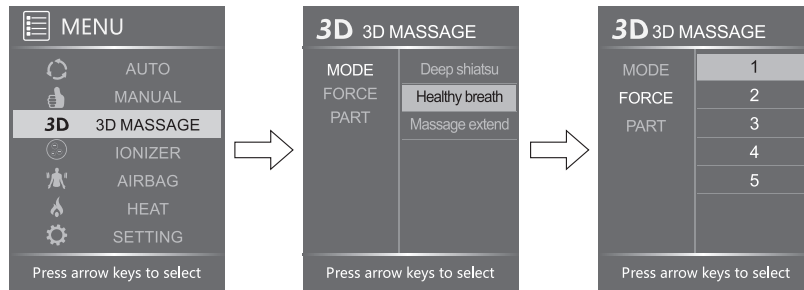

Deep shiatsu: deep shiatsu on the back for 10 minutes;
Healthy breath: 5 minutes healthy breath massage with rhythm for breathing in and out, which does good to the user's health.

Massage extend: 5 minutes massage extend mode.

FORCE: Under manual, 3D massage force is adjustable from 1 to 5 grades.

Part: Under Part function, press right button first, then press up or down button to choose whole, partial or point.

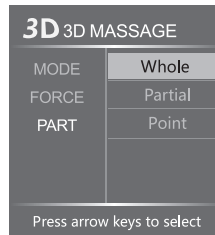

▶ PREPARATION BEFORE USING

Move method

- ▶ There are moving rollers at the bottom of the chair.
- ▶ Raise the back to the highest point.
- ▶ Unplug the chair.
- ▶ Lift the front part of the chair as showed in the figure (one person raise the front part via holding moving holder, another person push the chair when holding the top of the chair), move the chair by the rollers.

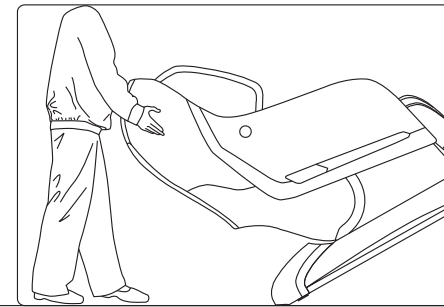

⚠ Caution

- ▶ Don't move chair when there are people in it.
- ▶ Don't use the armrest for moving the chair, only hold the moving holder in the back and front

Turn on power supply

- ▶ Plug the power cord into three prong grounded outlet only.
- ▶ Power on the chair by pressing the button at the lower part of the exterior of the right armrest.

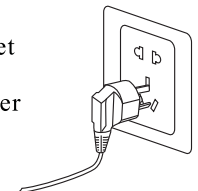

⚠ Caution

- ▶ Before switching on the chair, please make sure there is no damage on the power wire and other exposed wires.
- ▶ Make sure the power switch is off before the chair is connected to electricity.

▶ PREPARATION BEFORE USING

Step 5 Installation of controller unit

- ▶ Connect the data line of the controller to the port on the inner side of right armrest (pay attention to the convex-concave between connector and port); then fix the screw cap. (see the figure below)

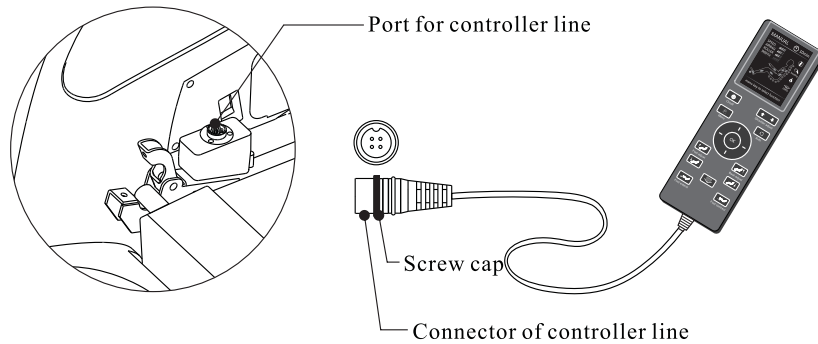

Step 6 Other Accessories

- ▶ Connect the power wire connector to the port on the outer side of right armrest;
- ▶ Switch on the chair, and use the controller to raise the backframe to normal position.

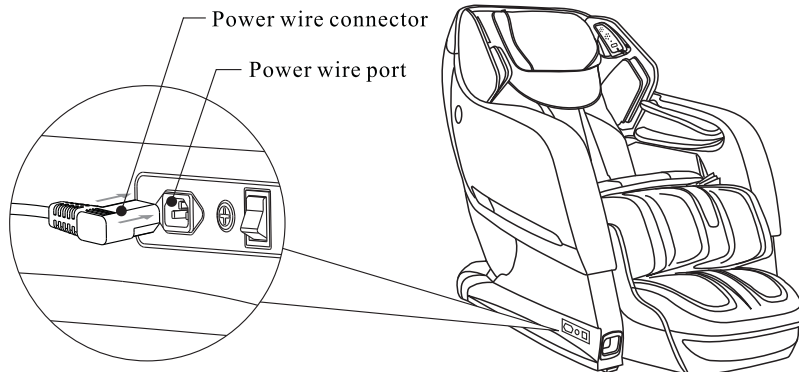

▶ NAME AND FUNCTION OF EACH COMPONENT

▶ IONIZER

Press MENU button first, then choose IONIZER, press up or down button to open or stop ionizer.

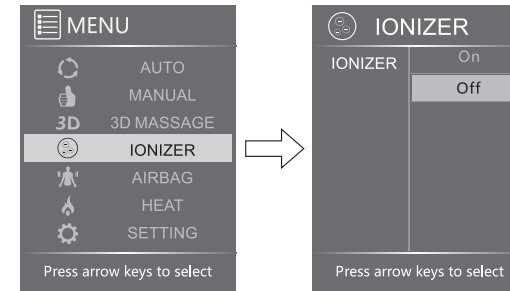

▶ AIRBAG

Press MENU button first, then choose AIRBAG, press up or down button to choose airbag place and force.

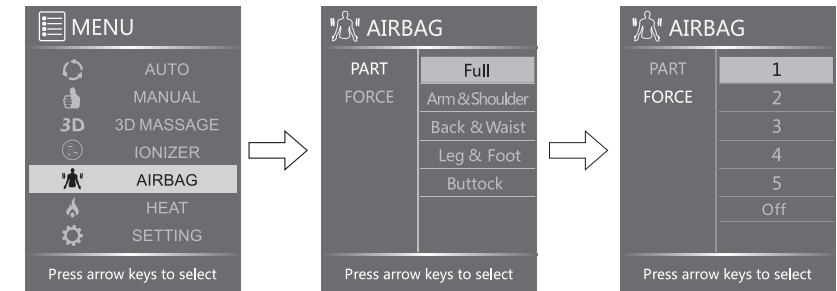

PART:

Under AIRBAG PART function, press right button first, then press up or down button to choose full, arm&shoulder, back&waist, leg&foot, or buttock.

FORCE:

Under AIRBAG FORCE function, press right button first, then press up or down button to choose airbag force from 1 to 5 grades and stop the airbag.

▶ NAME AND FUNCTION OF EACH COMPONENT

▶ Heat

Click MENU , choosing HEAT , then click right to choose on or off.

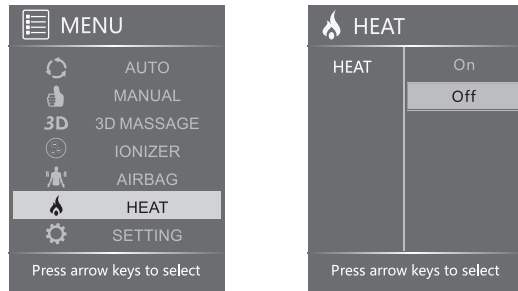

▶ SETTING

Press MENU button, choose SETTING, then press up or down button to set time, language or bluetooth.

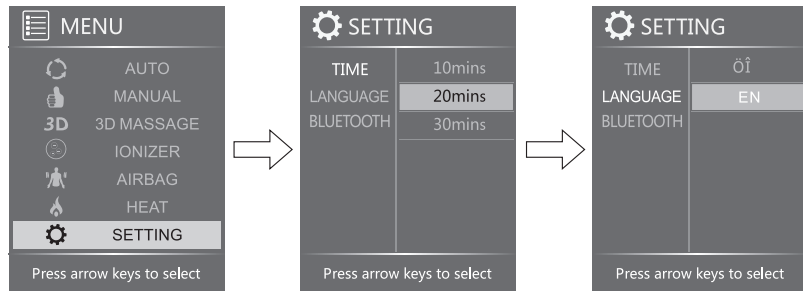

TIME: Under SETTING TIME function, press right button, then press up or down button to choose 10minutes, 20minutes or 30 minutes. The default setting is 20minutes.

LANGUAGE: Under SETTING LANGUAGE function, press right button, then press up or down button to set CHINESE or ENGLISH menu.

BLUETOOTH: Under SETTING BLUETOOTH function, then press up or down button to START or STOP bluetooth.

MEMO: All the above settings are remembered even when the machine is cut off suddenly.

▶ PREPARATION BEFORE USING

Step 4 Installation of legrest unit

▶ Install the inner cover and outer cover of leg frame onto the connecting shaft.

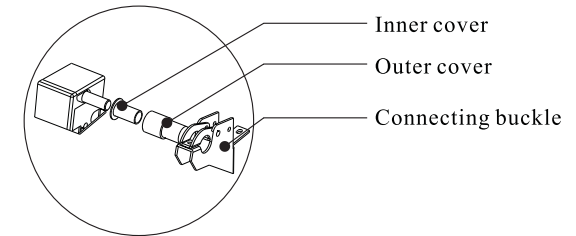

▶ Remove the screw on leg connecting buckle of the frame and open the buckle upwards, then put the leg units into the buckle groove of the frame. Close the buckle and fix it with bolt.

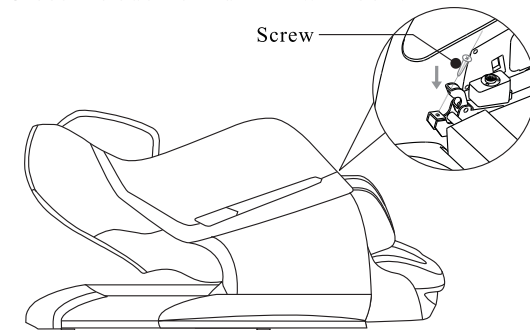

▶ Lift legrest units, put leg drive line plug into leg drive line socket, and air pipe into air tap. Make sure it is connected firmly. (Fig below)

▶ Connect the wrinkle cover of the leg massage unit with the velcro on the seat cloth.

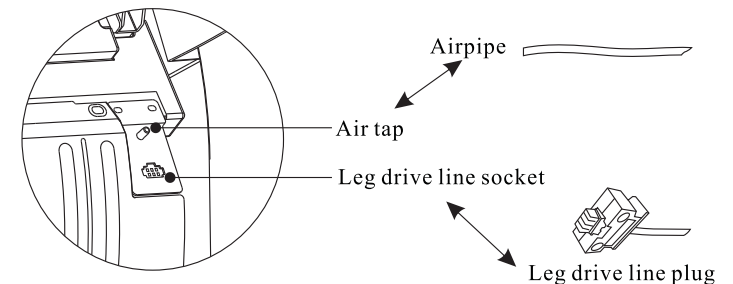

► PREPARATION BEFORE USING

Step 3 Installation of armrest units

- Match the air valve, color light, airpipe plugs on armrest to the side ports on lower part of the armrest frame. (follow the sequence in the diagram below)

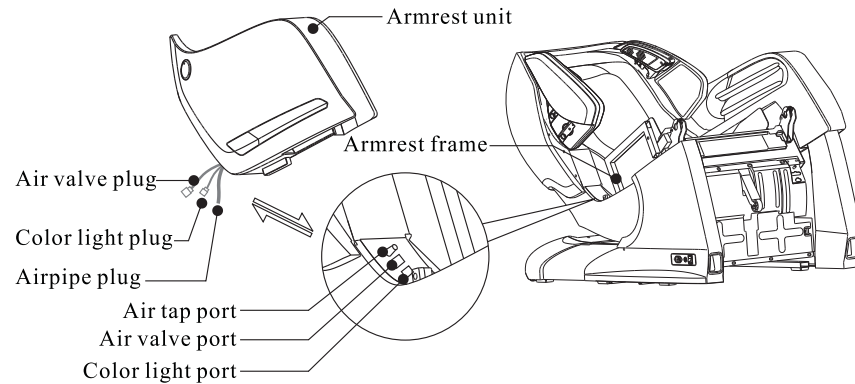

- After the cables from armrest are well connected, push downward after aiming the inner groove of armrest unit to armrest frame, then armrest unit will be connected into the armrest frame. Attach with a screw (a). (It is the same installation method for the other side)
- After the screw is tightly fixed, put the cover on (left and right are different), then fix the cover (b) by rotating clockwise.
- Use another screw to fix armrest from the interior (c).

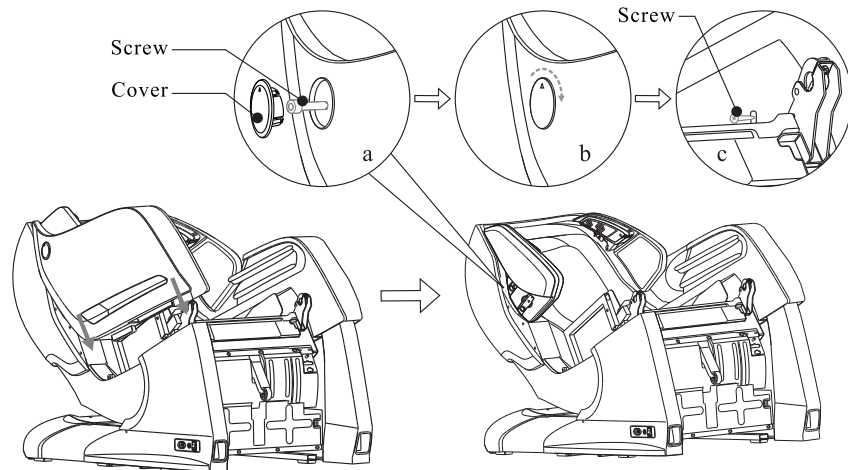

► NAME AND FUNCTION OF EACH COMPONENT

Note:

1. Under auto mode or manual mode screen will refresh back to main screen after 10 seconds of no input.

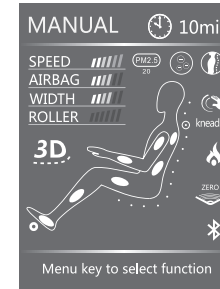

Home page in manual mode

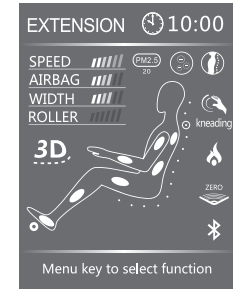

Home page in auto mode

⚠ Caution

- During massage, click MENU twice, it will go back to home page immediately.
- In the home page, under manual mode or auto mode, click the left and right button to adjust air pressure intensity; under manual mode, click up and down, to adjust massage wheels speed.
- Click AUTO to choose auto program directly.

⚠ Caution

- Please do not disassemble the massage chair for any reason.
- Please do not spill water or other liquids into the controller to avoid malfunction of keys and error code.
- Please do not put heavy things on the controller or power cable.

► PREPARATION BEFORE USING

Installation Method

Step 1: Get out each part of the chair

- Unpack the cartons, carefully get out cushion units, accessories box and so on.
- Check all accessories with packing list.

Step 2 air bag massage unit for shoulder and speaker installation

- Connect the shoulder airbag and speaker unit with connecting port. Connect the two connector pillar slots on shoulder airbag and
- speaker point at pillars on the massage backrest, and insert them. Then fix them with the three screws. (picture 2) Then fix the inside of speaker by two screws. (picture 3). Then install the cover. (picture 4)
- Installation method of the other side is the same as above.

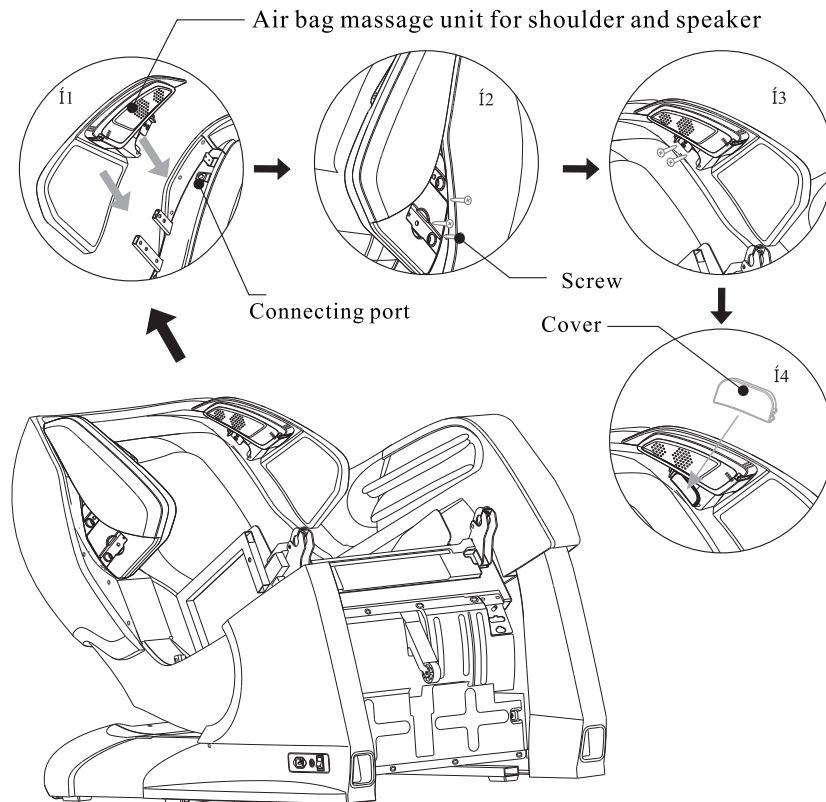

► USB CHARGING PORT

How To Use

Charger is 1 amp charger. Allows you to charge your phone/tablet while using the chair. Especially great when using the App/Apk to control the chair. Uses a Type A usb.

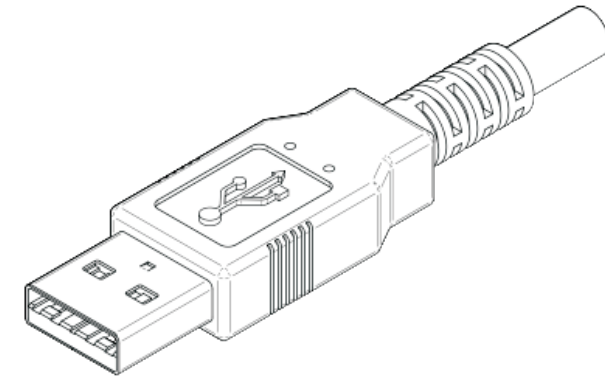

Port is located on left thigh area behind the thigh airbag.

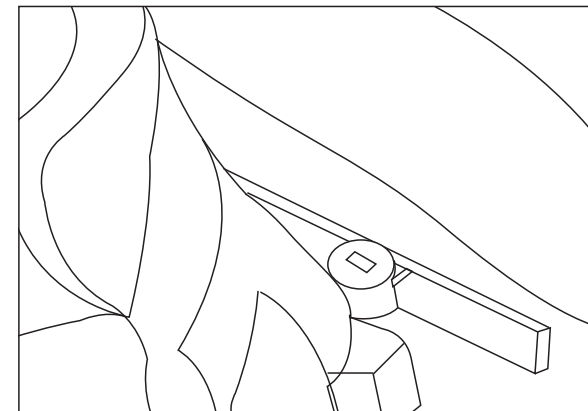

▶ MEMORY FUNCTION

1: Storing a memory program:

After selecting all of your wanted functions in the manual mode, go to the Auto page and scroll to the bottom of the page. Here you will see Memory A and Memory B. Select either A or B then select “Save”..

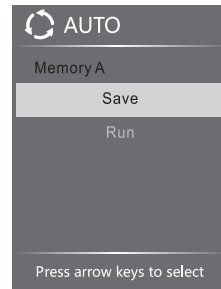
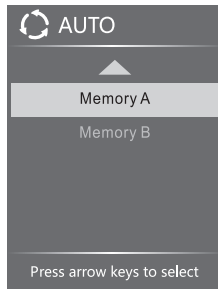

2: Loading a memory program

Go to the Auto page and scroll to the bottom of the page. Select Memory A or Memory B and then select “Run”. The chair will now run the program you created in the Manual mode.

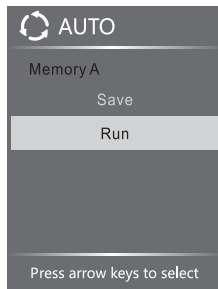

▶ FUNCTIONS AND FEATURES

1: Sliding

The Imperial massage chair has the ability to move forward before performing a massage so that it can be pushed closed to the wall than a normal massage chair. Keep this in mind when positioning the chair.

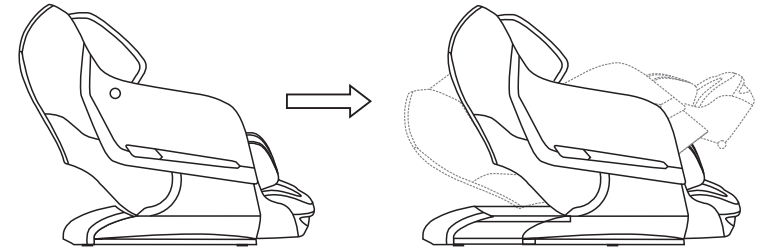

2: ZERO GRAVITY

Zero gravity creates a completely relaxing, naturally comfortable massage position: Somatological design makes back, buttocks and legs stay in a certain angle like lying in space capsule, under which the body pressure is thoroughly released and the muscles will be relaxed completely.

3: 3D massage mechanism

New 3D mechanism and movement perfectly correspond to the somatological principle.

4: AUTO/MANUAL EXTEND LEGREST

Legrest can extend 6.5” to match different height auto/manually.

5: AIRBAG MASSAGE

This massage chair has airbags at different places (arm, back, waist, shoulder, buttocks, leg and feet)

6: ROLLER MASSAGE FOR SOLE

around shatsu massage on roller with roller massage on feet contact an ll-T ree sole.

7: DIVERSIFIED MASSAGE MODES

kneading, knocking/ kneading, tapping knockin : Diversified massage modes, which. hia su and kneading on the leg simulate a professional massagist.

8: BLUETOOTH AUDIO

It can play music. Product is designed with bluetooth connection function on ipad, iphone, connecting with Android system.

9: DETECTION OF PM

This function can detect particulate matter in the air in real time.

10: SHAPE SLEEPING MASSAGE TACK-L

11: This product is designed with ionizer function.

▶ APP DOWNLOAD AND INSTALLATION

Bluetooth connection method

Apple ios is different from android, please see the details below:

Apple ios:(ipad for example)

1, Open App store  , at the top right corner input keywords like "Infinity massage chair, Imperial, or massage chair" and so on to download apple' s application program. In the application program users open bluetooth and connect it with massage chair. Only Apple equipment that has bluetooth 4.0 can connect with the chair's bluetooth.

Click "GET" at the top right corner, users can download and install the searched software.

2, open "massage chair  “, enter into APP program. Click the “setting" "bluetooth" and get connected.

Blue tooth

- ▶ This product has the ability to connect to bluetooth audio devices. Open bluetooth from audio devices, pair with Imperial for music play.

▶ APK INSTALLATION

Android System

Software

- ▶ Please ask for software from manufacturer, then install on the computer or mobile device. (Refer below pics.)
- ▶ Install Imperial APK then press setting button of the computer or mobile device , press wireless and web set / blue tooth / scan blue tooth device / Imperial, then pair.
Start the program. Then press setting menu / blue tooth connecting / pair with Imperial for operating the massage chair.

Caution

- ▶ When pairing blue tooth, please make sure the chair is powered on, otherwise the android device will not find the chair.

Equipment requirements

- ▶ Android device must be equipped with bluetooth function.
Android device must have OS higher than V2.2 Android System.